

METROSAFE COMMUNICATIONS MIGRATION PLAN



The design, technical, pricing, and other information ("Information") furnished with this submission is proprietary information of Motorola Solutions, Inc. ("Motorola") and is submitted with the restriction that it is to be used for evaluation purposes only. To the fullest extent allowed by applicable law, the Information is not to be disclosed publicly or in any manner to anyone other than those required to evaluate the Information without the express written permission of Motorola.

MOTOROLA, MOTO, MOTOROLA SOLUTIONS, and the Stylized M Logo are trademarks or registered trademarks of Motorola Trademark Holdings, LLC and are used under license. SYMBOL is a trademark owned by Symbol Technologies, Inc., which is a wholly owned subsidiary of Motorola Solutions, Inc. All other trademarks are the property of their respective owners. © 2013 Motorola Solutions, Inc. All rights reserved.

TABLE OF CONTENTS

Communications System Agreement.....	1
Exhibit A: SOFTWARE LICENSE AGREEMENT	16
Exhibit B-1: PRICING SUMMARY	22
Exhibit B-2: PAYMENT SCHEDULE.....	23
Exhibit C: TECHNICAL AND IMPLEMENTATION DOCUMENTS	25
Exhibit C-1: System Description.....	25
Exhibit C-2: Equipment List.....	27
Exhibit C-3: Statement of Work and Training Documentation.....	29
Exhibit C-4: Acceptance Test Plan.....	31
Exhibit C-5: Schedule	33
Exhibit D: SERVICE STATEMENT(S) OF WORK AND SERVICE TERMS AND CONDITIONS ..	35
Exhibit D-1: Warranty.....	35
Exhibit D-2: Service Statements of Work	37
Exhibit D-3: Service Terms and Conditions.....	39
Exhibit E: SYSTEM UPGRADE AGREEMENT (SUAI) STATEMENT OF WORK.....	45
Exhibit F: SYSTEM ACCEPTANCE CERTIFICATE.....	47

COMMUNICATIONS SYSTEM AGREEMENT

Motorola Solutions, Inc. (“Motorola”) and the Louisville/Jefferson County Metro Government, acting by and through Metro Safe (“Customer”) enter into this “Agreement,” pursuant to which Customer will purchase and Motorola will sell the System, as described below. Motorola and Customer may be referred to individually as a “Party” and collectively as the “Parties.” For good and valuable consideration, the Parties agree as follows:

Section 1 EXHIBITS

The exhibits listed below are incorporated into and made a part of this Agreement. In interpreting this Agreement and resolving any ambiguities, the main body of this Agreement takes precedence over the exhibits and any inconsistency between Exhibits A through F will be resolved in their listed order.

Exhibit A Motorola “Software License Agreement”

Exhibit B “Pricing Summary” and “Payment Schedule”

B-1 “Pricing Summary” dated July 31, 2014

B-2 “Payment Schedule” undated

Exhibit C “Technical and Implementation Documents”

C-1 “System Description” dated July 31, 2014

C-2 “Equipment List” dated July 31, 2014

C-3 “Statement of Work” dated July 31, 2014

C-4 “Acceptance Test Plan” or “ATP” dated July 31, 2014

C-5 “Performance Schedule” dated July 31, 2014

Exhibit D Service Statement(s) of Work and “Service Terms and Conditions”

D-1 “Warranty Documentation” dated July 31, 2014

D-2 2 Service Statements of Work undated

D-3 3 Service Terms and Conditions dated July 31, 2014 (if applicable)

Exhibit E System Upgrade Agreement Statement of Work

Exhibit F “System Acceptance Certificate”



Section 2 DEFINITIONS

Capitalized terms used in this Agreement have the following meanings:

- 2.1. “Acceptance Tests” means those tests described in the Acceptance Test Plan.
- 2.2. “Administrative User Credentials” means an account that has total access over the operating system, files, end user accounts and passwords at either the System level or box level. Customer’s personnel with access to the Administrative User Credentials may be referred to as the Administrative User.
- 2.3. “Beneficial Use” means when Customer first uses the System or a Subsystem for operational purposes (excluding training or testing).
- 2.4. “Confidential Information” means any information that is disclosed in written, graphic, verbal, or machine-recognizable form, and is marked, designated, or identified at the time of disclosure as being confidential or its equivalent; or if the information is in verbal form, it is identified as confidential at the time of disclosure and is confirmed in writing within thirty (30) days of the disclosure. Confidential Information does not include any information that: is or becomes publicly known through no wrongful act of the receiving Party; is already known to the receiving Party without restriction when it is disclosed; is or becomes, rightfully and without breach of this Agreement, in the receiving Party’s possession without any obligation restricting disclosure; is independently developed by the receiving Party without breach of this Agreement; or is explicitly approved for release by written authorization of the disclosing Party.
- 2.5. “Contract Price” means the price for the System, excluding applicable sales or similar taxes and freight charges, and including ten (10) years of SUA II upgrades (“Lifecycle Support Plan”).
- 2.6. “Effective Date” means that date upon which the last Party executes this Agreement.
- 2.7. “Equipment” means the equipment that Customer purchases from Motorola under this Agreement. Equipment that is part of the System is described in the Equipment List.
- 2.8. “Force Majeure” means an event, circumstance, or act of a third party that is beyond a Party’s reasonable control (e.g., an act of God, an act of the public enemy, an act of a government entity, strikes or other labor disturbances, hurricanes, earthquakes, fires, floods, epidemics, embargoes, war, and riots).
- 2.9. “Infringement Claim” means a third party claim alleging that the Equipment manufactured by Motorola or the Motorola Software directly infringes a United States patent or copyright.
- 2.10. “Motorola Software” means Software that Motorola or its affiliated company owns.
- 2.11. “Non-Motorola Software” means Software that another party owns.
- 2.12. “Open Source Software” (also called “freeware” or “shareware”) means software with either freely obtainable source code, license for modification, or permission for free distribution.
- 2.13. “Proprietary Rights” means the patents, patent applications, inventions, copyrights, trade secrets, trademarks, trade names, mask works, know-how, and other intellectual property rights in and to the Equipment and Software, including those created or produced by Motorola under this Agreement and any corrections, bug fixes, enhancements, updates or modifications to or derivative works from the Software whether made by Motorola or another party.



- 2.14. “Software” means the Motorola Software and Non-Motorola Software, in object code format that is furnished with the System or Equipment.
- 2.15. “Specifications” means the functionality and performance requirements that are described in the Technical and Implementation Documents.
- 2.16. “Subsystem” means a major part of the System that performs specific functions or operations. Subsystems are described in the Technical and Implementation Documents.
- 2.17. “System” means the Equipment, Software, and incidental hardware and materials that are combined together into an integrated system; the System is described in the Technical and Implementation Documents.
- 2.18. “System Acceptance” means the Acceptance Tests have been successfully completed.
- 2.19. “Warranty Period” means one (1) year from the date of System Acceptance or Beneficial Use, whichever occurs first.

Section 3 SCOPE OF AGREEMENT AND TERM

3.1. **SCOPE OF WORK.** Motorola will provide, install and test the System, and perform its other contractual responsibilities, all in accordance with this Agreement. Customer will perform its contractual responsibilities in accordance with this Agreement.

3.2. **CHANGE ORDERS.** Either Party may request changes within the general scope of this Agreement. If a requested change causes an increase or decrease in the cost or time required to perform this Agreement, the Parties will agree to an equitable adjustment of the Contract Price, Performance Schedule, or both, and will reflect the adjustment in a change order. Neither Party is obligated to perform requested changes unless both Parties execute a written change order.

TERM. Unless terminated in accordance with other provisions of this Agreement or extended by mutual agreement of the Parties, the term of this Agreement begins on the Effective Date and continues until completion of 10 years of Lifecycle Support Plan. Notwithstanding any term herein to the contrary, in the event that, during the term of this Contract, the Louisville Metro Council fails to appropriate funds for the payment of the Customer’s obligations under this Agreement, Customer shall immediately notify Motorola of such occurrence and the Customer’s rights and obligations herein shall terminate on the last day for which an appropriation has been made, without penalty or expense of any kind to the Customer, In the event of non-appropriation of funds by the governing body of Customer, the provisions below shall control:

Motorola agrees to waive any claims for damages.

Motorola agrees that its sole right and/or remedy will be the right to be paid the actual cost of all work properly performed by Motorola prior to the date of the termination.

3.3. **ADDITIONAL EQUIPMENT OR SOFTWARE.** For three (3) years after the Effective Date, Customer may order additional Equipment or Software if it is then available. Each order must refer to this Agreement and must specify the pricing and delivery terms. Notwithstanding any additional or contrary terms in the order, the applicable provisions of this Agreement (except for pricing, delivery, passage of title and risk of loss to Equipment, warranty commencement, and payment terms) will govern the purchase and sale of the additional Equipment or Software. Title and risk of loss to additional Equipment will pass at shipment, warranty will commence upon delivery, and payment is due within thirty (30) days after the invoice date. Motorola will send Customer an invoice as the additional Equipment is shipped or Software is licensed. Alternatively, Customer may register with and place orders through Motorola Online



(“MOL”), and this Agreement will be the “Underlying Agreement” for those MOL transactions rather than the MOL On-Line Terms and Conditions of Sale. MOL registration and other information may be found at <http://www.motorola.com/businessandgovernment/> and the MOL telephone number is (800) 814- 0601.

3.4. **SYSTEM UPGRADES.** During the ten (10) years of Lifecycle Support Plan, the applicable provisions of this Agreement (except for passage of title and risk of loss to Equipment, warranty commencement, and Exhibit C) will govern the implementation of the System Upgrades. Title and risk of loss to Equipment will pass at shipment, and warranty will commence upon delivery.

3.5. **MAINTENANCE SERVICE.** During the Warranty Period, in addition to warranty services, Motorola will provide maintenance services for the Equipment and support for the Motorola Software pursuant to the Statement of Work set forth in Exhibit D. Those services and support are included in the Contract Price. If Customer wishes to purchase additional maintenance and support services for the Equipment during the Warranty Period, or any maintenance and support services for the Equipment either during the Warranty Period or after the Warranty Period, the description of and pricing for the services will be set forth in a separate document. If Customer wishes to purchase extended support for the Motorola Software after the Warranty Period, it may do so by ordering software subscription services. Unless otherwise agreed by the parties in writing, the terms and conditions applicable to those maintenance, support or software subscription services will be Motorola’s standard Service Terms and Conditions, together with the appropriate statements of work.

3.6. **MOTOROLA SOFTWARE.** Any Motorola Software, including subsequent releases, is licensed to Customer solely in accordance with the Software License Agreement. Customer hereby accepts and agrees to abide by all of the terms and restrictions of the Software License Agreement.

3.7. **NON-MOTOROLA SOFTWARE.** Any Non-Motorola Software is licensed to Customer in accordance with the standard license, terms, and restrictions of the copyright owner on the Effective Date unless the copyright owner has granted to Motorola the right to sublicense the Non-Motorola Software pursuant to the Software License Agreement, in which case it applies and the copyright owner will have all of Licensor’s rights and protections under the Software License Agreement. Motorola makes no representations or warranties of any kind regarding Non-Motorola Software. Non-Motorola Software may include Open Source Software. All Open Source Software is licensed to Customer in accordance with, and Customer agrees to abide by, the provisions of the standard license of the copyright owner and not the Software License Agreement. Upon request by Customer, Motorola will use commercially reasonable efforts to determine whether any Open Source Software will be provided under this Agreement; and if so, identify the Open Source Software and provide to Customer a copy of the applicable standard license (or specify where that license may be found); and provide to Customer a copy of the Open Source Software source code if it is publicly available without charge (although a distribution fee or a charge for related services may be applicable).

3.8. **SUBSTITUTIONS.** At no additional cost to Customer, Motorola may substitute any Equipment, Software, or services to be provided by Motorola, if the substitute meets or exceeds the Specifications and is of equivalent or better quality to the Customer. Any substitution will be reflected in a change order.

3.9. **OPTIONAL EQUIPMENT OR SOFTWARE.** This paragraph applies only if a “Priced Options” exhibit is shown in Section 1, or if the parties amend this Agreement to add a Priced Options exhibit. During the term of the option as stated in the Priced Options exhibit (or if no term is stated, then for one (1) year after the Effective Date), Customer has the right and option to purchase the equipment, software, and related services that are described in the Priced Options exhibit. Customer may exercise this option by giving written notice to Seller which must designate what equipment, software, and related services Customer is selecting (including quantities, if applicable). To the extent they apply, the terms and conditions of this Agreement will govern the transaction; however, the parties acknowledge that certain provisions must be agreed upon, and they agree to negotiate those in



good faith promptly after Customer delivers the option exercise notice. Examples of provisions that may need to be negotiated are: specific lists of deliverables, statements of work, acceptance test plans, delivery and implementation schedules, payment terms, maintenance and support provisions, additions to or modifications of the Software License Agreement, hosting terms, and modifications to the acceptance and warranty provisions.

Section 4 PERFORMANCE SCHEDULE

The Parties will perform their respective responsibilities in accordance with the Performance Schedule. By executing this Agreement, Customer authorizes Motorola to proceed with contract performance. The Customer will not be issuing a Purchase Order (PO) or any other Notice to Proceed (NTP) for the entirety of this contract and the annual payments can be processed solely against this contract.

Section 5 CONTRACT PRICE, PAYMENT AND INVOICING

5.1. **CONTRACT PRICE.** The Contract Price in U.S. dollars is \$13,992,378. A Pricing Summary is included with the Payment Schedule in Exhibit B. The System price is \$7,755,567 and the ten (10) year Lifecycle Support Plan price is \$6,236,811, based on initial System design. Motorola has priced the services, Software, and Equipment as an integrated system. A change in Software or Equipment quantities, or services, may affect the overall Contract Price, including discounts if applicable. Further, at the end of the first year of the Agreement and each year thereafter, a CPI percentage change calculation shall be performed. Should the annual inflation rate increase greater than 5% during the previous year, Motorola shall have the right to increase all future maintenance prices by the CPI increase amount exceeding 5%. The Midwest Region Consumer Price Index (<http://www.bls.gov/ro5/cpimid.htm>), All items, Not seasonally adjusted shall be used as the measure of CPI for this price adjustment. Measurement will take place once the annual average for the new year has been posted by the Bureau of Labor Statistics.

5.2. **INVOICING AND PAYMENT.** Motorola will submit invoices to Customer according to the Payment Schedule. Except for a payment that is due on the Effective Date, Customer will make payments to Motorola within thirty (30) days after the date of each invoice. Customer will make payments when due in the form of a wire transfer, check, or cashier's check from a U.S. financial institution. Overdue invoices will bear simple interest at the maximum allowable rate. For reference, the Federal Tax Identification Number for Motorola Solutions, Inc. is 36-1115800.

5.3. **FREIGHT, TITLE, AND RISK OF LOSS.** Motorola will pay and all freight charges. Title to the Equipment will pass to Customer upon shipment. Title to Software will not pass to Customer at any time. Risk of loss will pass to Customer upon inspection of the Equipment at the Customer's location. Motorola will pack and ship all Equipment in accordance with good commercial practices..

5.4. **INVOICING AND SHIPPING ADDRESSES.** Invoices will be sent to the Customer at the following address:

The address which is the ultimate destination where the Equipment will be delivered to Customer is:

The Equipment will be shipped to the Customer at the following address (insert if this information is known):

Customer may change this information by giving written notice to Motorola.



Section 6 SITES AND SITE CONDITIONS

6.1. ACCESS TO SITES. In addition to its responsibilities described elsewhere in this Agreement, Customer will provide a designated project manager; all necessary construction and building permits, zoning variances, licenses, and any other approvals that are necessary to develop or use the sites and mounting locations; and access to the work sites or vehicles identified in the Technical and Implementation Documents as reasonably requested by Motorola so that it may perform its duties in accordance with the Performance Schedule and Statement of Work. If the Statement of Work so indicates, Motorola may assist Customer in the local building permit process.

6.2. SITE CONDITIONS. Customer will ensure that all work sites it provides will be safe, secure, and in compliance with all applicable industry and OSHA standards. To the extent applicable and unless the Statement of Work states to the contrary, Customer will ensure that these work sites have adequate: physical space; air conditioning and other environmental conditions; adequate and appropriate electrical power outlets, distribution, equipment and connections; and adequate telephone or other communication lines (including modem access and adequate interfacing networking capabilities), all for the installation, use and maintenance of the System. Before installing the Equipment or Software at a work site, Motorola may inspect the work site and advise Customer of any apparent deficiencies or non-conformities with the requirements of this Section. This Agreement is predicated upon normal soil conditions as defined by the version of E.I.A. standard RS-222 in effect on the Effective Date.

6.3. SITE ISSUES. If a Party determines that the sites identified in the Technical and Implementation Documents are no longer available or desired, or if subsurface, structural, adverse environmental or latent conditions at any site differ from those indicated in the Technical and Implementation Documents, the Parties will promptly investigate the conditions and will select replacement sites or adjust the installation plans and specifications as necessary. If change in sites or adjustment to the installation plans and specifications causes a change in the cost or time to perform, the Parties will equitably amend the Contract Price, Performance Schedule, or both, by a change order.

Section 7 TRAINING

Any training to be provided by Motorola to Customer will be described in the Statement of Work. Customer will notify Motorola immediately if a date change for a scheduled training program is required. If Motorola incurs additional costs because Customer reschedules a training program less than thirty (30) days before its scheduled start date, Motorola may recover these additional costs.

Section 8 SYSTEM ACCEPTANCE

8.1. COMMENCEMENT OF ACCEPTANCE TESTING. Motorola will provide to Customer at least ten (10) days notice before the Acceptance Tests commence. System testing will occur only in accordance with the Acceptance Test Plan.

8.2. SYSTEM ACCEPTANCE. System Acceptance will occur upon successful completion of the Acceptance Tests. Upon System Acceptance, the Parties will memorialize this event by promptly executing a System Acceptance Certificate. If the Acceptance Test Plan includes separate tests for individual Subsystems or phases of the System, acceptance of the individual Subsystem or phase will occur upon the successful completion of the Acceptance Tests for the Subsystem or phase, and the Parties will promptly execute an acceptance certificate for the Subsystem or phase. If Customer believes the System has failed the completed Acceptance Tests, Customer will provide to Motorola a written notice that includes the specific details of the failure. If Customer does not provide to Motorola a failure notice within thirty (30) days after completion of the Acceptance Tests, System Acceptance will be deemed to have occurred as of the completion of the Acceptance Tests.



Minor omissions or variances in the System that do not materially impair the operation of the System as a whole will not postpone System Acceptance or Subsystem acceptance, but will be corrected according to a mutually agreed schedule.

8.3. **BENEFICIAL USE.** Customer acknowledges that Motorola's ability to perform its implementation and testing responsibilities may be impeded if Customer begins using the System before System Acceptance. Therefore, Customer will not commence Beneficial Use before System Acceptance without Motorola's prior written authorization, which will not be unreasonably withheld. Motorola is not responsible for System performance deficiencies that occur during unauthorized Beneficial Use. Upon commencement of Beneficial Use, Customer assumes responsibility for the use and operation of the System.

8.4 **FINAL PROJECT ACCEPTANCE.** Final Project Acceptance will occur after System Acceptance when all deliverables and other work have been completed. When Final Project Acceptance occurs, the parties will promptly memorialize this final event by so indicating on the System Acceptance Certificate.

Section 9 REPRESENTATIONS AND WARRANTIES

9.1. **SYSTEM FUNCTIONALITY.** Motorola represents that the System will perform in accordance with the Specifications in all material respects. Upon System Acceptance or Beneficial Use, whichever occurs first, this System functionality representation is fulfilled. Motorola is not responsible for System performance deficiencies that are caused by ancillary equipment not furnished by Motorola which is attached to or used in connection with the System or for reasons or parties beyond Motorola's control, such as natural causes; the construction of a building that adversely affects the microwave path reliability or radio frequency (RF) coverage; the addition of frequencies at System sites that cause RF interference or intermodulation; or Customer changes to load usage or configuration outside the Specifications.

9.2. **EQUIPMENT WARRANTY.** During the Warranty Period, Motorola warrants that the Equipment under normal use and service will be free from material defects in materials and workmanship. If System Acceptance is delayed beyond six (6) months after shipment of the Equipment by events or causes within Customer's control, this warranty expires eighteen (18) months after the shipment of the Equipment.

9.3. **MOTOROLA SOFTWARE WARRANTY.** Unless otherwise stated in the Software License Agreement, during the Warranty Period, Motorola warrants the Motorola Software in accordance with the terms of the Software License Agreement and the provisions of this Section 9 that are applicable to the Motorola Software. If System Acceptance is delayed beyond six (6) months after shipment of the Motorola Software by events or causes within Customer's control, this warranty expires eighteen (18) months after the shipment of the Motorola Software. **TO THE EXTENT, IF ANY, THAT THERE IS A SEPARATE LICENSE AGREEMENT PACKAGED WITH, OR PROVIDED ELECTRONICALLY WITH, A PARTICULAR PRODUCT THAT BECOMES EFFECTIVE ON AN ACT OF ACCEPTANCE BY THE END USER, THEN THAT AGREEMENT SUPERCEDES THIS SOFTWARE LICENSE AGREEMENT AS TO THE END USER OF EACH SUCH PRODUCT.**

9.4. **EXCLUSIONS TO EQUIPMENT AND MOTOROLA SOFTWARE WARRANTIES.** These warranties do not apply to: (i) defects or damage resulting from: use of the Equipment or Motorola Software in other than its normal, customary, and authorized manner; accident, liquids, neglect, or acts of God; testing, maintenance, disassembly, repair, installation, alteration, modification, or adjustment not provided or authorized in writing by Motorola; Customer's failure to comply with all applicable industry and OSHA standards; (ii) breakage of or damage to antennas unless caused directly by defects in material or workmanship; (iii) Equipment that has had the serial number removed or made illegible; (iv) batteries (because they carry their own separate limited warranty) or consumables; (v) freight costs to ship Equipment to the repair depot; (vi) scratches or other cosmetic



damage to Equipment surfaces that does not affect the operation of the Equipment; and (vii) normal or customary wear and tear.

9.5. **WARRANTY CLAIMS.** To assert a warranty claim, Customer must notify Motorola in writing of the claim before the expiration of the Warranty Period. Upon receipt of this notice, Motorola will investigate the warranty claim. If this investigation confirms a valid warranty claim, Motorola will (at its option and at no additional charge to Customer) repair the defective Equipment or Motorola Software, replace it with the same or equivalent product, or refund the price of the defective Equipment or Motorola Software. That action will be the full extent of Motorola's liability for the warranty claim. If this investigation indicates the warranty claim is not valid, then Motorola may invoice Customer for responding to the claim on a time and materials basis using Motorola's then current labor rates. Repaired or replaced product is warranted for the balance of the original applicable warranty period. All replaced products or parts will become the property of Motorola.

9.6. **ORIGINAL END USER IS COVERED.** These express limited warranties are extended by Motorola to the original user purchasing the System for commercial, industrial, or governmental use only, and are not assignable or transferable.

9.7. **DISCLAIMER OF OTHER WARRANTIES.** THESE WARRANTIES ARE THE COMPLETE WARRANTIES FOR THE EQUIPMENT AND MOTOROLA SOFTWARE PROVIDED UNDER THIS AGREEMENT AND ARE GIVEN IN LIEU OF ALL OTHER WARRANTIES. MOTOROLA DISCLAIMS ALL OTHER WARRANTIES OR CONDITIONS, EXPRESS OR IMPLIED, INCLUDING THE IMPLIED WARRANTIES OF MERCHANTABILITY AND FITNESS FOR A PARTICULAR PURPOSE.

Section 10 DELAYS

10.1. **FORCE MAJEURE.** Neither Party will be liable for its non-performance or delayed performance if caused by a Force Majeure. A Party that becomes aware of a Force Majeure that will significantly delay performance will notify the other Party promptly (but in no event later than fifteen days) after it discovers the Force Majeure. If a Force Majeure occurs, the Parties will execute a change order to extend the Performance Schedule for a time period that is reasonable under the circumstances.

10.2. **PERFORMANCE SCHEDULE DELAYS CAUSED BY CUSTOMER.** If Customer (including its other contractors) delays the Performance Schedule, it will make the promised payments according to the Payment Schedule as if no delay occurred; and the Parties will execute a change order to extend the Performance Schedule and, if requested, compensate Motorola for all reasonable charges incurred because of the delay. Delay charges may include costs incurred by Motorola or its subcontractors for additional freight, warehousing and handling of Equipment; extension of the warranties; travel; suspending and re-mobilizing the work; additional engineering, project management, and standby time calculated at then current rates; and preparing and implementing an alternative implementation plan.

Section 11 DISPUTES

The Parties will use the following procedure to address any dispute arising under this Agreement (a "Dispute").

11.1. **GOVERNING LAW.** This Agreement will be governed by and construed in accordance with the laws of the State in which the System is installed.

11.2. **NEGOTIATION.** Either Party may initiate the Dispute resolution procedures by sending a notice of Dispute ("Notice of Dispute"). The Parties will attempt to resolve the Dispute promptly through good faith negotiations including 1) timely escalation of the Dispute to executives who have



authority to settle the Dispute and who are at a higher level of management than the persons with direct responsibility for the matter and 2) direct communication between the executives. If the Dispute has not been resolved within ten (10) days from the Notice of Dispute, the Parties will proceed to mediation.

11.3 MEDIATION. The Parties will choose an independent mediator within thirty (30) days of a notice to mediate from either Party (“Notice of Mediation”). Neither Party may unreasonably withhold consent to the selection of a mediator. If the Parties are unable to agree upon a mediator, either Party may request that American Arbitration Association nominate a mediator. Each Party will bear its own costs of mediation, but the Parties will share the cost of the mediator equally. Each Party will participate in the mediation in good faith and will be represented at the mediation by a business executive with authority to settle the Dispute.

11.4. LITIGATION, VENUE and JURISDICTION. If a Dispute remains unresolved for sixty (60) days after receipt of the Notice of Mediation, either Party may then submit the Dispute to a court of competent jurisdiction in the state in which the System is installed. Each Party irrevocably agrees to submit to the exclusive jurisdiction of the courts in such state over any claim or matter arising under or in connection with this Agreement.

11.5. CONFIDENTIALITY. All communications pursuant to subsections 11.2 and 11.3 will be treated as compromise and settlement negotiations for purposes of applicable rules of evidence and any additional confidentiality protections provided by applicable law. The use of these Dispute resolution procedures will not be construed under the doctrines of laches, waiver or estoppel to affect adversely the rights of either Party.

Section 12 DEFAULT AND TERMINATION

12.1 DEFAULT BY A PARTY. If either Party fails to perform a material obligation under this Agreement, the other Party may consider the non-performing Party to be in default (unless a Force Majeure causes the failure) and may assert a default claim by giving the non-performing Party a written and detailed notice of default. Except for a default by Customer for failing to pay any amount when due under this Agreement which must be cured immediately, the defaulting Party will have thirty (30) days after receipt of the notice of default to either cure the default or, if the default is not curable within thirty (30) days, provide a written cure plan. The defaulting Party will begin implementing the cure plan immediately after receipt of notice by the other Party that it approves the plan. If Customer is the defaulting Party, Motorola may stop work on the project until it approves the Customer’s cure plan.

FAILURE TO CURE. If a defaulting Party fails to cure the default as provided above in Section 12.1, unless otherwise agreed in writing, the non-defaulting Party may terminate any unfulfilled portion of this Agreement. In the event of termination for default, the defaulting Party will promptly return to the non-defaulting Party any of its Confidential Information. If Customer is the non-defaulting Party, terminates this Agreement as permitted by this Section, and completes the System through a third Party, Customer may as its exclusive remedy recover from Motorola reasonable costs incurred to complete the System to a capability not exceeding that specified in this Agreement less the unpaid portion of the Contract Price. Customer will mitigate damages and provide Motorola with detailed invoices substantiating the charges.

12.2. CONVENIENCE. Customer may terminate this Agreement (in whole or part) at any time. To exercise this right, Customer must provide to Motorola formal written notice at least thirty (30) days in advance of the effective date of the termination. The notice must explicitly state the effective date of the termination and whether the contract termination is in whole or in part, and if in part, which part is being terminated. If Customer exercises this right to terminate for convenience, it will be liable to pay Motorola for (1) the portion of the Contract Price attributable to the Equipment and/or Software delivered, and all services performed, on or before the effective date of the termination; and (2) costs and expenses that Motorola incurs as a result of the termination of the Agreement, including but not limited to costs and expenses associated with cancellation of

subcontracts, restocking fees, removal of installation or test equipment, etc. If the portion of the Contract Price and/or the recoverable costs and expenses attributable to the termination of the Agreement are not readily ascertainable, Customer will be liable to pay Motorola for the reasonable value of such Equipment, Software, services, costs and expenses. Notwithstanding the above, Customer shall have no right to terminate this Agreement if Motorola has given Customer a notice of default and such default has not been cured.

Section 13 INDEMNIFICATION AND INSURANCE

13.1. GENERAL INDEMNITY BY MOTOROLA. Motorola will indemnify and hold Customer, its elected officials, employees, agents and successors in interest harmless from any and all liability, expense, judgment, suit, cause of action, or demand for bodily or personal injury, death, or direct damage to tangible property which may accrue against Customer to the extent it is caused by the negligence of Motorola, its subcontractors, or their employees or agents, while performing their duties under this Agreement, if Customer gives Motorola prompt, written notice of any the claim or suit. Customer will cooperate with Motorola in its defense or settlement of the claim or suit. This section sets forth the full extent of Motorola's general indemnification of Customer from liabilities that are in any way related to Motorola's performance under this Agreement.

13.2. GENERAL INDEMNITY BY CUSTOMER. Customer will indemnify and hold Motorola harmless from any and all liability, expense, judgment, suit, cause of action, or demand for bodily or personal injury, death, or direct damage to tangible property which may accrue against Motorola to the extent it is caused by the negligence of Customer, or its employees acting within their scope of employment, while performing their duties under this Agreement, if Motorola gives Customer prompt, written notice of any the claim or suit. Motorola will cooperate with Customer in its defense or settlement of the claim or suit. This section sets forth the full extent of Customer's general indemnification of Motorola from liabilities that are in any way related to Customer's performance under this Agreement.

13.3. PATENT AND COPYRIGHT INFRINGEMENT.

13.3.1. Motorola will defend at its expense any suit brought against Customer, its elected officials, employees, agents and successors in interest to the extent it is based on a third-party claim alleging that the Equipment manufactured by Motorola or the Motorola Software ("Motorola Product") directly infringes a United States patent or copyright ("Infringement Claim"). Motorola's duties to defend and indemnify are conditioned upon: Customer promptly notifying Motorola in writing of the Infringement Claim; Motorola having sole control of the defense of the suit and all negotiations for its settlement or compromise; and Customer providing to Motorola cooperation and, if requested by Motorola, reasonable assistance in the defense of the Infringement Claim. In addition to Motorola's obligation to defend, and subject to the same conditions, Motorola will pay all damages finally awarded against Customer by a court of competent jurisdiction for an Infringement Claim or agreed to, in writing, by Motorola in settlement of an Infringement Claim.

13.3.2. If an Infringement Claim occurs, or in Motorola's opinion is likely to occur, Motorola may at its option and expense: (a) procure for Customer the right to continue using the Motorola Product; (b) replace or modify the Motorola Product so that it becomes non-infringing while providing functionally equivalent performance; or (c) accept the return of the Motorola Product and grant Customer a credit for the Motorola Product, less a reasonable charge for depreciation. The depreciation amount will be calculated based upon generally accepted accounting standards.

13.3.3. Motorola will have no duty to defend or indemnify for any Infringement Claim that is based upon: (a) the combination of the Motorola Product with any software, apparatus or device not furnished by Motorola; (b) the use of ancillary equipment or software not furnished by Motorola and that is attached to or used in connection with the Motorola Product; (c) Motorola Product designed or



manufactured in accordance with Customer's designs, specifications, guidelines or instructions, if the alleged infringement would not have occurred without such designs, specifications, guidelines or instructions; (d) a modification of the Motorola Product by a party other than Motorola; (e) use of the Motorola Product in a manner for which the Motorola Product was not designed or that is inconsistent with the terms of this Agreement; or (f) the failure by Customer to install an enhancement release to the Motorola Software that is intended to correct the claimed infringement. In no event will Motorola's liability resulting from its indemnity obligation to Customer extend in any way to royalties payable on a per use basis or the Customer's revenues, or any royalty basis other than a reasonable royalty based upon revenue derived by Motorola from Customer from sales or license of the infringing Motorola Product.

13.3.4. This Section 13 provides Customer's sole and exclusive remedies and Motorola's entire liability in the event of an Infringement Claim. Customer has no right to recover and Motorola has no obligation to provide any other or further remedies, whether under another provision of this Agreement or any other legal theory or principle, in connection with an Infringement Claim. In addition, the rights and remedies provided in this Section 13 are subject to and limited by the restrictions set forth in Section 14.

13.4. INSURANCE REQUIREMENTS.

Prior to commencing work, Motorola shall obtain at its own cost and expense the following types of insurance through insurance companies licensed in the State of Kentucky. Insurance written by non-admitted carriers will also be considered acceptable, in accordance with Kentucky Insurance Law (KRS 304.10-040). Workers' Compensation written through qualified group self-insurance programs in accordance with Kentucky Revised Statutes (KRS 342.350) will also be acceptable. Motorola shall not commence work under this Contract until all insurance required under the Contract Document has been obtained and until copy of certificate of insurance thereof are submitted to **Louisville/Jefferson County Metro Government's Purchasing Division** and approved by the Louisville/Jefferson County Metro Government's Risk Management Division. Motorola shall not allow any subcontractors to commence work until the insurance required of such subcontractors has been obtained and copies of Certificates of Insurance retained by Contractor evidencing proof of coverages.

Without limiting Motorola's indemnification requirements, it is agreed that Motorola shall maintain in force at all times during the performance of this agreement the following policy or policies of insurance covering its operations, and require subcontractors, if subcontracting is authorized, to procure and maintain these same policies until final acceptance of the work by the Louisville/Jefferson County Metro Government (Metro). Metro may require Motorola to supply proof of subcontractors insurance via Certificates of Insurance.

- A. Louisville, **Louisville/Jefferson County Metro Government, its elected and appointed officials, employees, and successors are listed as an "Additional Insured" as respects operations of the Named Insured performed relative to the contract under the general and automobile liability policies by means of blanket Additional Insured endorsements.**
- B. The insurance to be procured and maintained and **minimum** Limits of Liability shall be as follows, unless different limits are specified by addendum to the contract
 - 1. **COMMERCIAL GENERAL LIABILITY**, via the **Occurrence Form**, primary, non contributory ,with a **\$5,000,000*** Combined Single Limit for any one Occurrence and **\$5,000,000**** aggregate for Bodily Injury, Personal Injury, Property Damage, and Products/Completed Operations including:
 - a. Premises - Operations Coverage
 - b. Products and Completed Operations
 - c. Contractual Liability
 - d. Broad Form Property Damage



- e. Independent Contractors Protective Liability
 - f. Personal Injury
2. **AUTOMOBILE LIABILITY**, insuring all Owned, Non-Owned and Hired Motor Vehicles. The minimum coverage Liability Limit is **\$5,000,000*** Combined Single Limit for any one accident. The Limit of Liability may be subject to increase according to any applicable State or Federal Transportation Regulations.
3. **WORKERS' COMPENSATION (IF APPLICABLE)** insuring the employers' obligations under Kentucky Revised Statutes Chapter 342 at Statutory Limits, and **EMPLOYERS' LIABILITY - \$100,000** Each Accident/**\$500,000** Disease - Policy Limit/**\$100,000** Disease - Each Employee.

*\$1,000,000 applies to subcontractors insurance requirements

**\$2,000,000 aggregate applies to subcontractors insurance requirements

ACCEPTABILITY OF INSURERS

Insurance is to be placed with Insurance Companies with an A. M. Best Rating of no less than "A- VI", unless proper financial information relating to the Company is submitted to and approved by Metro's Risk Management Division.

MISCELLANEOUS

A. Motorola shall procure and maintain insurance policies as described herein and for which the **Louisville/Jefferson County Metro Government's Purchasing Division** shall be furnished Certificates of Insurance upon the execution of the Contract. The Certificates shall include the name and address of the agency executing the Certificate of Insurance. If policies expire before the completion of the Contract, renewal Certificates of Insurance shall be furnished to Metro prior to or upon the expiration of any policy(s).

B. **Upon execution of the contract, Certificates of Insurance as required above shall be furnished to:**

Louisville/Jefferson County Metro Government
Office of Management and Budget
Purchasing Division
611 West Jefferson Street
Louisville, Kentucky 40202

C. **Upon Renewal of insurance coverage (s), Certificates of Insurance evidencing renewal shall be furnished to:**

Louisville/Jefferson County Metro Government
Office of Management and Budget
Risk Management Division
611 West Jefferson Street
Louisville, Kentucky 40202

D. **CANCELLATION OR MATERIAL CHANGE OF COVERAGE: Contractor shall notify Metro's Risk Management Division of any policy cancellation within ten (10) business days of its receipt of same. If Contractor fails to notify Metro as required by this Agreement, Contractor agrees that such failure**



shall be a breach of this Agreement

E. Approval of the insurance by Metro shall not in any way relieve or decrease the liability of Contractor hereunder. It is expressly understood that Metro does not in any way represent that the specified Limits of Liability or coverage or policy forms are sufficient or adequate to protect the interest or liabilities of Contractor.

Section 14 LIMITATION OF LIABILITY

Except for bodily or personal injury or death or any third party claims, Motorola's total liability, whether for breach of contract, warranty, negligence, strict liability in tort, indemnification, or otherwise, will be limited to the direct damages recoverable under law, but not to exceed the price of the Equipment, Software, or services with respect to which losses or damages are claimed. ALTHOUGH THE PARTIES ACKNOWLEDGE THE POSSIBILITY OF SUCH LOSSES OR DAMAGES, THEY AGREE THAT MOTOROLA WILL NOT BE LIABLE FOR ANY COMMERCIAL LOSS; INCONVENIENCE; LOSS OF USE, TIME, DATA, GOOD WILL, REVENUES, PROFITS OR SAVINGS; OR OTHER SPECIAL, INCIDENTAL, INDIRECT, OR CONSEQUENTIAL DAMAGES IN ANY WAY RELATED TO OR ARISING FROM THIS AGREEMENT, THE SALE OR USE OF THE EQUIPMENT OR SOFTWARE, OR THE PERFORMANCE OF SERVICES BY MOTOROLA PURSUANT TO THIS AGREEMENT. This limitation of liability provision survives the expiration or termination of the Agreement and applies notwithstanding any contrary provision. No action for contract breach or otherwise relating to the transactions contemplated by this

Section 15 CONFIDENTIALITY AND PROPRIETARY RIGHTS

15.1. CONFIDENTIAL INFORMATION. During the term of this Agreement, the parties may provide each other with Confidential Information. Each Party will: maintain the confidentiality of the other Party's Confidential Information and not disclose it to any third party, except as authorized by the disclosing Party in writing, as required by a court of competent jurisdiction or as required by the Kentucky Open Records Act, KRS 61.870, *et. seq.*; restrict disclosure of the Confidential Information to its employees who have a "need to know" and not copy or reproduce the Confidential Information; take necessary and appropriate precautions to guard the confidentiality of the Confidential Information, including informing its employees who handle the Confidential Information that it is confidential and is not to be disclosed to others, but these precautions will be at least the same degree of care that the receiving Party applies to its own confidential information and will not be less than reasonable care; and use the Confidential Information only in furtherance of the performance of this Agreement. Confidential Information is and will at all times remain the property of the disclosing Party, and no grant of any proprietary rights in the Confidential Information is given or intended, including any express or implied license, other than the limited right of the recipient to use the Confidential Information in the manner and to the extent permitted by this Agreement.

15.2. PRESERVATION OF MOTOROLA'S PROPRIETARY RIGHTS. Motorola, the third party manufacturer of any Equipment, and the copyright owner of any Non-Motorola Software own and retain all of their respective Proprietary Rights in the Equipment and Software, and nothing in this Agreement is intended to restrict their Proprietary Rights. All intellectual property developed, originated, or prepared by Motorola in connection with providing to Customer the Equipment, Software, or related services remain vested exclusively in Motorola, and this Agreement does not grant to Customer any shared development rights of intellectual property. Except as explicitly provided in the Software License Agreement, Motorola does not grant to Customer, either directly or by implication, estoppel, or otherwise, any right, title or interest in Motorola's Proprietary Rights. Customer will not modify, disassemble, peel components, decompile, otherwise reverse engineer or attempt to reverse engineer, derive source code or create derivative works from, adapt, translate, merge with other software, reproduce, distribute, sublicense, sell or export the Software, or permit or

encourage any third party to do so. The preceding sentence does not apply to Open Source Software which is governed by the standard license of the copyright owner.

Section 16 GENERAL

16.1. **TAXES.** The Contract Price does not include any excise, sales, lease, use, property, or other taxes, assessments or duties, all of which will be paid by Customer except as exempt by law. If Motorola is required to pay any of these taxes, Motorola will send an invoice to Customer and Customer will pay to Motorola the amount of the taxes (including any interest and penalties) within thirty (30) days after the date of the invoice. Customer will be solely responsible for reporting the Equipment for personal property tax purposes, and Motorola will be solely responsible for reporting taxes on its income or net worth.

16.2. **ASSIGNABILITY AND SUBCONTRACTING.** Except as provided herein, neither Party may assign this Agreement or any of its rights or obligations hereunder without the prior written consent of the other Party, which consent will not be unreasonably withheld. Any attempted assignment, delegation, or transfer without the necessary consent will be void. Notwithstanding the foregoing, Motorola may assign this Agreement to any of its affiliates or its right to receive payment without the prior consent of Customer. In addition, in the event Motorola separates one or more of its businesses (each a “Separated Business”), whether by way of a sale, establishment of a joint venture, spin-off or otherwise (each a “Separation Event”), Motorola may, without the prior written consent of the other Party and at no additional cost to Motorola, assign this Agreement such that it will continue to benefit the Separated Business and its affiliates (and Motorola and its affiliates, to the extent applicable) following the Separation Event. Motorola may subcontract any of the work, but subcontracting will not relieve Motorola of its duties under this Agreement.

16.3 **WAIVER.** Failure or delay by either Party to exercise a right or power under this Agreement will not be a waiver of the right or power. For a waiver of a right or power to be effective, it must be in a writing signed by the waiving Party. An effective waiver of a right or power will not be construed as either a future or continuing waiver of that same right or power, or the waiver of any other right or power.

16.4. **SEVERABILITY.** If a court of competent jurisdiction renders any part of this Agreement invalid or unenforceable, that part will be severed and the remainder of this Agreement will continue in full force and effect.

16.5. **INDEPENDENT CONTRACTORS.** Each Party will perform its duties under this Agreement as an independent contractor. The Parties and their personnel will not be considered to be employees or agents of the other Party. Nothing in this Agreement will be interpreted as granting either Party the right or authority to make commitments of any kind for the other. This Agreement will not constitute, create, or be interpreted as a joint venture, partnership or formal business organization of any kind.

16.6. **HEADINGS AND SECTION REFERENCES.** The section headings in this Agreement are inserted only for convenience and are not to be construed as part of this Agreement or as a limitation of the scope of the particular section to which the heading refers. This Agreement will be fairly interpreted in accordance with its terms and conditions and not for or against either Party.

16.7. **ENTIRE AGREEMENT.** This Agreement, including all Exhibits, constitutes the entire agreement of the Parties regarding the subject matter of the Agreement and supersedes all previous agreements, proposals, and understandings, whether written or oral, relating to this subject matter. This Agreement may be executed in multiple counterparts, each of which shall be an original and all of which shall constitute one and the same instrument. A facsimile copy or computer image, such as a PDF or tiff



image, or a signature shall be treated as and shall have the same effect as an original signature. In addition, a true and correct facsimile copy or computer image of this Agreement shall be treated as and shall have the same effect as an original signed copy of this document. This Agreement may be amended or modified only by a written instrument signed by authorized representatives of both Parties. The preprinted terms and conditions found on any Customer purchase order, acknowledgment or other form will not be considered an amendment or modification of this Agreement, even if a representative of each Party signs that document.

16.8. NOTICES. Notices required under this Agreement to be given by one Party to the other must be in writing and either personally delivered or sent to the address shown below by certified mail, return receipt requested and postage prepaid (or by a recognized courier service, such as Federal Express, UPS, or DHL), or by facsimile with correct answerback received, and will be effective upon receipt:

Motorola Solutions, Inc.	Customer
Attn: Law Department	Attn: _____
1303 East Algonquin Road, 10th Floor	_____
Schaumburg, Il 60196	_____
fax: (847) 538-0838	fax: _____

16.9. COMPLIANCE WITH APPLICABLE LAWS. Each Party will comply with all applicable federal, state, and local laws, regulations and rules concerning the performance of this Agreement or use of the System. Customer will obtain and comply with all Federal Communications Commission (“FCC”) licenses and authorizations required for the installation, operation and use of the System before the scheduled installation of the Equipment. Although Motorola might assist Customer in the preparation of its FCC license applications, neither Motorola nor any of its employees is an agent or representative of Customer in FCC or other matters.

16.10. AUTHORITY TO EXECUTE AGREEMENT. Each Party represents that it has obtained all necessary approvals, consents and authorizations to enter into this Agreement and to perform its duties under this Agreement; the person executing this Agreement on its behalf has the authority to do so; upon execution and delivery of this Agreement by the Parties, it is a valid and binding contract, enforceable in accordance with its terms; and the execution, delivery, and performance of this Agreement does not violate any bylaw, charter, regulation, law or any other governing authority of the Party.

16.11. ADMINISTRATOR LEVEL ACCOUNT ACCESS. Motorola will provide Customer with Administrative User Credentials. Customer agrees to only grant Administrative User Credentials to those personnel with the training or experience to correctly use the access. Customer is responsible for protecting Administrative User Credentials from disclosure and maintaining Credential validity by, among other things, updating passwords when required. Customer may be asked to provide valid Administrative User Credentials when in contact with Motorola System support. Customer understands that changes made as the Administrative User can significantly impact the performance of the System. Customer agrees that it will be solely responsible for any negative impact on the System or its users by any such changes. System issues occurring as a result of changes made by an Administrative User may impact Motorola’s ability to perform its obligations under the Agreement or its Maintenance and Support Agreement. In such cases, a revision to the appropriate provisions of the Agreement, including the Statement of Work, may be necessary. To the extent Motorola provides assistance to correct any issues caused by or arising out of the use of or failure to maintain Administrative User Credentials, Motorola will be entitled to bill Customer and Customer

will pay Motorola on a time and materials basis for resolving the issue.

16.12. SURVIVAL OF TERMS. The following provisions will survive the expiration or termination of this Agreement for any reason: Section 3.7 (Motorola Software); Section 3.8 (Non-Motorola Software); if any payment obligations exist, Sections 5.1 and 5.2 (Contract Price and Invoicing and Payment); Subsection 9.7 (Disclaimer of Implied Warranties); Section 11 (Disputes); Section 14 (Limitation of Liability); and Section 15 (Confidentiality and Proprietary Rights); and all of the General provisions in Section 16.

16.13. RECORDS AUDIT. Motorols shall maintain during the course of the work, and retain not less than five years from the date of final payment on this Contract, complete and accurate records of all of Motorola's costs which are chargeable to the Customer under this Agreement; and the Customer shall have the right, at any reasonable time, to inspect and audit those records by authorized representatives of its own or of any public accounting firm selected by itCustomer's inspection is limited to the verification of shipment or service to invoices and receipts. Customer must provide thirty days' written notice and the audit must be conducted during normal business hours. Motorola's books and records provided to Customer pursuant to this provision shall not be used, duplicated or disclosed to any other third party without the express written permission of Motorola. In no circumstances will Motorola be required to create or maintain documents no kept in the ordinary course of Motorola business operations, nor will Motorola be required to disclose any information, including but not limited to product cost data, which it considers confidential or proprietary to Motorola.

16.14. CONFLICTS OF INTEREST.

Pursuant to KRS 45A.455:

(1) It shall be a breach of ethical standards for any employee with procurement authority to participate directly in any proceeding or application; request for ruling or other determination; claim or controversy; or other particular matter pertaining to any contract, or subcontract, and any solicitation or proposal therefor, in which to his knowledge:

(a) He, or any member of his immediate family has a financial interest therein; or

(b) A business or organization in which he or any member of his immediate family has a financial interest as an officer, director, trustee, partner, or employee, is a party; or

(c) Any other person, business, or organization with whom he or any member of his immediate family is negotiating or has an arrangement concerning prospective employment is a party. Direct or indirect participation shall include but not be limited to involvement through decision, approval, disapproval, recommendation, preparation of any part of a purchase request, influencing the content of any specification or purchase standard, rendering of advice, investigation, auditing, or in any other advisory capacity.

(2) It shall be a breach of ethical standards for any person to offer, give, or agree to give any employee or former employee, or for any employee or former employee to solicit, demand, accept, or agree to accept from another person, a gratuity or an offer of employment, in connection with any decision, approval, disapproval, recommendation, preparation of any part of a purchase request, influencing the content of any specification or purchase standard, rendering of advice, investigation, auditing, or in any other advisory capacity in any proceeding or application, request for ruling or other determination, claim or controversy, or other particular matter, pertaining to any contract or subcontract and any solicitation or proposal therefor.

(3) It is a breach of ethical standards for any payment, gratuity, or offer of employment to be made by or on behalf of a subcontractor under a contract to the prime contractor or higher tier subcontractor or any person associated therewith, as an inducement for the award of a subcontract or order.

(4) The prohibition against conflicts of interest and gratuities and kickbacks shall be conspicuously set forth in every local public agency written contract and solicitation therefor.

(5) It shall be a breach of ethical standards for any public employee or former employee knowingly



to use confidential information for his actual or anticipated personal gain, or the actual or anticipated personal gain of any other person.

16.5 Motorola shall reveal any final determination of a violation by Motorola or subcontractor within the previous five (5) year period pursuant to KRS Chapters 136, 139, 141, 337, 338, 341 and 342 that apply to the Motorola or subcontractor. Motorola shall be in continuous compliance with the provisions of KRS Chapters 136, 139, 141, 337, 338, 341 and 342 that apply to Motorola or subcontractor for the duration of the contract.

The Parties hereby enter into this Agreement as of the Effective Date.

Motorola Solutions, Inc. _____

By: _____

Name: JOHN ZIDAR

Title: VICE PRESIDENT

Date: 8/25/15

Customer: Louisville Metro Government

Customer: _____

Name: Debbi W. Fox

Title: Appointed Director - Emergency Services

Date: 08/25/15

Approved as to form and Legality:

Michael J. O'Connell
Jefferson County Attorney
Date: _____



EXHIBIT A: SOFTWARE LICENSE AGREEMENT

This Exhibit A Software License Agreement ("Agreement") is between Motorola Solutions, Inc. ("Motorola"), and the Louisville/Jefferson County Metro Government, acting by and through Metro Safe Licensee").

For good and valuable consideration, the parties agree as follows:

Section 1 DEFINITIONS

1.1 "Designated Products" means products provided by Motorola to Licensee with which or for which the Software and Documentation is licensed for use.

1.2 "Documentation" means product and software documentation that specifies technical and performance features and capabilities, and the user, operation and training manuals for the Software (including all physical or electronic media upon which such information is provided).

1.3 "Open Source Software" means software with either freely obtainable source code, license for modification, or permission for free distribution.

1.4 "Open Source Software License" means the terms or conditions under which the Open Source Software is licensed.

1.5 "Primary Agreement" means the agreement to which this exhibit is attached.

1.6 "Security Vulnerability" means a flaw or weakness in system security procedures, design, implementation, or internal controls that could be exercised (accidentally triggered or intentionally exploited) and result in a security breach such that data is compromised, manipulated or stolen or the system damaged.

1.7 "Software" (i) means proprietary software in object code format, and adaptations, translations, de-compilations, disassemblies, emulations, or derivative works of such software; (ii) means any modifications, enhancements, new versions and new releases of the software provided by Motorola; and (iii) may contain one or more items of software owned by a third party supplier. The term "Software" does not include any third party software provided under separate license or third party software not licensable under the terms of this Agreement.

Section 2 SCOPE

Motorola and Licensee enter into this Agreement in connection with Motorola's delivery of certain proprietary Software or products containing embedded or pre-loaded proprietary Software, or both. This Agreement contains the terms and conditions of the license Motorola is providing to Licensee, and Licensee's use of the Software and Documentation.

Section 3 GRANT OF LICENSE

3.1. Subject to the provisions of this Agreement and the payment of applicable license fees, Motorola grants to Licensee a personal, limited, non-transferable (except as permitted in Section 7) and non-exclusive license under Motorola's copyrights and Confidential Information (as defined in the



Primary Agreement) embodied in the Software to use the Software, in object code form, and the Documentation solely in connection with Licensee's use of the Designated Products. This Agreement does not grant any rights to source code.

3.2. If the Software licensed under this Agreement contains or is derived from Open Source Software, the terms and conditions governing the use of such Open Source Software are in the Open Source Software Licenses of the copyright owner and not this Agreement. If there is a conflict between the terms and conditions of this Agreement and the terms and conditions of the Open Source Software Licenses governing Licensee's use of the Open Source Software, the terms and conditions of the license grant of the applicable Open Source Software Licenses will take precedence over the license grants in this Agreement. If requested by Licensee, Motorola will use commercially reasonable efforts to: (i) determine whether any Open Source Software is provided under this Agreement; (ii) identify the Open Source Software and provide Licensee a copy of the applicable Open Source Software License (or specify where that license may be found); and, (iii) provide Licensee a copy of the Open Source Software source code, without charge, if it is publicly available (although distribution fees may be applicable).

Section 4 LIMITATIONS ON USE

4.1. Licensee may use the Software only for Licensee's internal business purposes and only in accordance with the Documentation. Any other use of the Software is strictly prohibited. Without limiting the general nature of these restrictions, Licensee will not make the Software available for use by third parties on a "time sharing," "application service provider," or "service bureau" basis or for any other similar commercial rental or sharing arrangement.

4.2. Licensee will not, and will not allow or enable any third party to: (i) reverse engineer, disassemble, peel components, decompile, reprogram or otherwise reduce the Software or any portion to a human perceptible form or otherwise attempt to recreate the source code; (ii) modify, adapt, create derivative works of, or merge the Software; (iii) copy, reproduce, distribute, lend, or lease the Software or Documentation to any third party, grant any sublicense or other rights in the Software or Documentation to any third party, or take any action that would cause the Software or Documentation to be placed in the public domain; (iv) remove, or in any way alter or obscure, any copyright notice or other notice of Motorola's proprietary rights; (v) provide, copy, transmit, disclose, divulge or make the Software or Documentation available to, or permit the use of the Software by any third party or on any machine except as expressly authorized by this Agreement; or (vi) use, or permit the use of, the Software in a manner that would result in the production of a copy of the Software solely by activating a machine containing the Software. Licensee may make one copy of Software to be used solely for archival, back-up, or disaster recovery purposes; provided that Licensee may not operate that copy of the Software at the same time as the original Software is being operated. Licensee may make as many copies of the Documentation as it may reasonably require for the internal use of the Software.

4.3. Unless otherwise authorized by Motorola in writing, Licensee will not, and will not enable or allow any third party to: (i) install a licensed copy of the Software on more than one unit of a Designated Product; or (ii) copy onto or transfer Software installed in one unit of a Designated Product onto one other device. Licensee may temporarily transfer Software installed on a Designated Product to another device if the Designated Product is inoperable or malfunctioning, if Licensee provides written notice to Motorola of the temporary transfer and identifies the device on which the Software is transferred. Temporary transfer of the Software to another device must be discontinued when the original Designated Product is returned to operation and the Software must be removed from the other device. Licensee must provide prompt written notice to Motorola at the time temporary transfer is discontinued.



4.4. When using Motorola's Radio Service Software ("RSS"), Licensee must purchase a separate license for each location at which Licensee uses RSS. Licensee's use of RSS at a licensed location does not entitle Licensee to use or access RSS remotely. Licensee may make one copy of RSS for each licensed location. Licensee shall provide Motorola with a list of all locations at which Licensee uses or intends to use RSS upon Motorola's request.

4.5. Licensee will maintain, during the term of this Agreement and for a period of two years thereafter, accurate records relating to this license grant to verify compliance with this Agreement. Motorola or an independent third party ("Auditor") may inspect Licensee's premises, books and records, upon reasonable prior notice to Licensee, during Licensee's normal business hours and subject to Licensee's facility and security regulations. Motorola is responsible for the payment of all expenses and costs of the Auditor. Any information obtained by Motorola and the Auditor will be kept in strict confidence by Motorola and the Auditor and used solely for the purpose of verifying Licensee's compliance with the terms of this Agreement.

Section 5 OWNERSHIP AND TITLE

Motorola, its licensors, and its suppliers retain all of their proprietary rights in any form in and to the Software and Documentation, including, but not limited to, all rights in patents, patent applications, inventions, copyrights, trademarks, trade secrets, trade names, and other proprietary rights in or relating to the Software and Documentation (including any corrections, bug fixes, enhancements, updates, modifications, adaptations, translations, de-compilations, disassemblies, emulations to or derivative works from the Software or Documentation, whether made by Motorola or another party, or any improvements that result from Motorola's processes or, provision of information services). No rights are granted to Licensee under this Agreement by implication, estoppel or otherwise, except for those rights which are expressly granted to Licensee in this Agreement. All intellectual property developed, originated, or prepared by Motorola in connection with providing the Software, Designated Products, Documentation or related services, remains vested exclusively in Motorola, and Licensee will not have any shared development or other intellectual property rights.

Section 6 LIMITED WARRANTY; DISCLAIMER OF WARRANTY

6.1. The commencement date and the term of the Software warranty will be a period of ninety (90) days from Motorola's shipment of the Software (the "Warranty Period"). If Licensee is not in breach of any of its obligations under this Agreement, Motorola warrants that the unmodified Software, when used properly and in accordance with the Documentation and this Agreement, will be free from a reproducible defect that eliminates the functionality or successful operation of a feature critical to the primary functionality or successful operation of the Software. Whether a defect occurs will be determined by Motorola solely with reference to the Documentation. Motorola does not warrant that Licensee's use of the Software or the Designated Products will be uninterrupted, error-free, completely free of Security Vulnerabilities, or that the Software or the Designated Products will meet Licensee's particular requirements. Motorola makes no representations or warranties with respect to any third party software included in the Software.

6.2 Motorola's sole obligation to Licensee and Licensee's exclusive remedy under this warranty is to use reasonable efforts to remedy any material Software defect covered by this warranty. These efforts will involve either replacing the media or attempting to correct significant, demonstrable program or documentation errors or Security Vulnerabilities. If Motorola cannot correct the defect within a reasonable time, then at Motorola's option, Motorola will replace the defective Software with functionally-equivalent Software, license to Licensee substitute Software which will accomplish the same objective, or terminate the license and refund the Licensee's paid license fee.



6.3. Warranty claims are described in the Primary Agreement.

6.4. The express warranties set forth in this Section 6 are in lieu of, and Motorola disclaims, any and all other warranties (express or implied, oral or written) with respect to the Software or Documentation, including, without limitation, any and all implied warranties of condition, title, non-infringement, merchantability, or fitness for a particular purpose or use by Licensee (whether or not Motorola knows, has reason to know, has been advised, or is otherwise aware of any such purpose or use), whether arising by law, by reason of custom or usage of trade, or by course of dealing. In addition, Motorola disclaims any warranty to any person other than Licensee with respect to the Software or Documentation.

Section 7 TRANSFERS

Licensee will not transfer the Software or Documentation to any third party without Motorola's prior written consent. Motorola's consent may be withheld at its discretion and may be conditioned upon transferee paying all applicable license fees and agreeing to be bound by this Agreement. If the Designated Products are Motorola's radio products and Licensee transfers ownership of the Motorola radio products to a third party, Licensee may assign its right to use the Software (other than RSS and Motorola's FLASHport® software) which is embedded in or furnished for use with the radio products and the related Documentation; provided that Licensee transfers all copies of the Software and Documentation to the transferee, and Licensee and the transferee sign a transfer form to be provided by Motorola upon request, obligating the transferee to be bound by this Agreement.

Section 8 TERM AND TERMINATION

8.1 Licensee's right to use the Software and Documentation will begin when the Primary Agreement is signed by both parties and will continue for the life of the Designated Products with which or for which the Software and Documentation have been provided by Motorola, unless Licensee breaches this Agreement, in which case this Agreement and Licensee's right to use the Software and Documentation may be terminated immediately upon notice by Motorola.

8.2 Within thirty (30) days after termination of this Agreement, Licensee must certify in writing to Motorola that all copies of the Software have been removed or deleted from the Designated Products and that all copies of the Software and Documentation have been returned to Motorola or destroyed by Licensee and are no longer in use by Licensee.

8.3 Licensee acknowledges that Motorola made a considerable investment of resources in the development, marketing, and distribution of the Software and Documentation and that Licensee's breach of this Agreement will result in irreparable harm to Motorola for which monetary damages would be inadequate. If Licensee breaches this Agreement, Motorola may terminate this Agreement and be entitled to all available remedies at law or in equity (including immediate injunctive relief and repossession of all non-embedded Software and associated Documentation unless Licensee is a Federal agency of the United States Government).

Section 9 UNITED STATES GOVERNMENT LICENSING PROVISIONS

This Section applies if Licensee is the United States Government or a United States Government agency. Licensee's use, duplication or disclosure of the Software and Documentation under Motorola's copyrights or trade secret rights is subject to the restrictions set forth in subparagraphs (c)(1) and (2) of the Commercial Computer Software-Restricted Rights clause at FAR 52.227-19



(JUNE 1987), if applicable, unless they are being provided to the Department of Defense. If the Software and Documentation are being provided to the Department of Defense, Licensee's use, duplication, or disclosure of the Software and Documentation is subject to the restricted rights set forth in subparagraph (c)(1)(ii) of the Rights in Technical Data and Computer Software clause at DFARS 252.227-7013 (OCT 1988), if applicable. The Software and Documentation may or may not include a Restricted Rights notice, or other notice referring to this Agreement. The provisions of this Agreement will continue to apply, but only to the extent that they are consistent with the rights provided to the Licensee under the provisions of the FAR or DFARS mentioned above, as applicable to the particular procuring agency and procurement transaction.

Section 10 CONFIDENTIALITY

Licensee acknowledges that the Software and Documentation contain Motorola's valuable proprietary and Confidential Information and are Motorola's trade secrets, and that the provisions in the Primary Agreement concerning Confidential Information apply.

Section 11 LIMITATION OF LIABILITY

The Limitation of Liability provision is described in the Primary Agreement.

Section 12 NOTICES

Notices are described in the Primary Agreement.

Section 13 GENERAL

13.1. **COPYRIGHT NOTICES.** The existence of a copyright notice on the Software will not be construed as an admission or presumption of publication of the Software or public disclosure of any trade secrets associated with the Software.

13.2. **COMPLIANCE WITH LAWS.** Licensee acknowledges that the Software is subject to the laws and regulations of the United States and Licensee will comply with all applicable laws and regulations, including export laws and regulations of the United States. Licensee will not, without the prior authorization of Motorola and the appropriate governmental authority of the United States, in any form export or re-export, sell or resell, ship or reship, or divert, through direct or indirect means, any item or technical data or direct or indirect products sold or otherwise furnished to any person within any territory for which the United States Government or any of its agencies at the time of the action, requires an export license or other governmental approval. Violation of this provision is a material breach of this Agreement.

13.3. **ASSIGNMENTS AND SUBCONTRACTING.** Motorola may assign its rights or subcontract its obligations under this Agreement, or encumber or sell its rights in any Software, without prior notice to or consent of Licensee.

13.4. **GOVERNING LAW.** This Agreement is governed by the laws of the United States to the extent that they apply and otherwise by the internal substantive laws of the State to which the Software is shipped if Licensee is a sovereign government entity, or the internal substantive laws of the State of Illinois if Licensee is not a sovereign government entity. The terms of the U.N. Convention on Contracts for the International Sale of Goods do not apply. In the event that the



Uniform Computer Information Transaction Act, any version of this Act, or a substantially similar law (collectively "UCITA") becomes applicable to a party's performance under this Agreement, UCITA does not govern any aspect of this Agreement or any license granted under this Agreement, or any of the parties' rights or obligations under this Agreement. The governing law will be that in effect prior to the applicability of UCITA.

13.5. **THIRD PARTY BENEFICIARIES.** This Agreement is entered into solely for the benefit of Motorola and Licensee. No third party has the right to make any claim or assert any right under this Agreement, and no third party is deemed a beneficiary of this Agreement. Notwithstanding the foregoing, any licensor or supplier of third party software included in the Software will be a direct and intended third party beneficiary of this Agreement.

13.6. **SURVIVAL.** Sections 4, 5, 6.4, 7, 8, 9, 10, 11 and 13 survive the termination of this Agreement.

13.7. **ORDER OF PRECEDENCE.** In the event of inconsistencies between this Exhibit and the Primary Agreement, the parties agree that this Exhibit prevails, only with respect to the specific subject matter of this Exhibit, and not the Primary Agreement or any other exhibit as it applies to any other subject matter.

13.8 **SECURITY.** Motorola uses reasonable means in the design and writing of its own Software and the acquisition of third party Software to limit Security Vulnerabilities. While no software can be guaranteed to be free from Security Vulnerabilities, if a Security Vulnerability is discovered, Motorola will take the steps set forth in Section 6 of this Agreement.



EXHIBIT B-1: PRICING SUMMARY

Description	Price
P25 6.9 to 7.15 Core Migration, IP Simulcast, MCC7500/7100 operator position upgrades, conventional voting upgrade, VHF paging upgrade, Mutual Aid upgrade, WAVE upgrade, FSA upgrade	\$ 10,539,806.00
System Integration Services, Staging, Training, NICE and Microwave Subcontracting	\$ 2,279,430.00
Equipment and Services Sub-Total	\$ 12,819,236.00
Equipment Discount per KY MA 758_1300000945	\$ (1,342,507.00)
Credit for install labor to be performed by the Louisville MetroSafe Radio Shop	\$ (699,066.00)
Timing discount (contract prior to August 28, 2015)	\$ (672,664.00)
P25 System Upgrade with 10 yr SUA package discount	\$ (2,349,432.00)
Total Discount	\$ (5,063,669.00)
Upgrade Grand Total	\$ 7,755,567.00
10 YEAR Motorola System Upgrade Agreement (SUA II) <i>Invoiced annually at \$623,681/yr.</i>	\$ 6,236,811.00
P25 6.9 to 7.15 Core Migration, IP Simulcast & MCC Dispatch Positions Equipment & Systems Integration Services Total & 10 YEAR Motorola System Upgrade Agreement (SUA II)	\$ 13,992,378.00



EXHIBIT B-2: PAYMENT SCHEDULE

For System Purchase:

Except for a payment that is due on the Effective Date, Customer will make payments to Motorola within thirty (30) days after the date of each invoice. Customer will make payments when due in the form of a check, cashier's check, or wire transfer drawn on a U.S. financial institution and in accordance with the following milestones:

1. 25% of the System Price due upon contract execution.
2. 40% of the System Price due upon shipment of equipment.
3. 15% of the System Price due upon installation of equipment.
4. 15% of the System Price upon system acceptance or start of beneficial use; and
5. 5% of the System Price due upon Final Acceptance.

Motorola reserves the right to make partial shipments of equipment and to request payment upon shipment of such equipment. In addition, Motorola reserves the right to invoice for installations or civil work completed on a site-by-site basis, when applicable.

For SUAll/Lifecycle Support Plan (based on initial System design)

Customer plans to appropriate yearly according to the Pricing Schedule in Exhibit B-1. Motorola will notify the Customer when the SUA/Lifecycle Support Plan start dates are determined after System Acceptance. Motorola will then invoice the Customer annually in advance of each year of the plan. All invoices will reference this contract. Customer will make payments to Motorola within thirty (30) days of the Metro Council's approval of the appropriation to fund the SUA after the date of each invoice. Customer will make payments when due in the form of a check, cashier's check, or wire transfer drawn on a U.S. financial institution in accordance with the following schedule.



EXHIBIT C-1

SYSTEM DESCRIPTION

METROSAFE COMMUNICATIONS MIGRATION PLAN

FEBRUARY 2015



The design, technical, pricing, and other information ("Information") furnished with this submission is proprietary information of Motorola Solutions, Inc. ("Motorola") and is submitted with the restriction that it is to be used for evaluation purposes only. To the fullest extent allowed by applicable law, the Information is not to be disclosed publicly or in any manner to anyone other than those required to evaluate the Information without the express written permission of Motorola.

MOTOROLA, MOTO, MOTOROLA SOLUTIONS, and the Stylized M Logo are trademarks or registered trademarks of Motorola Trademark Holdings, LLC and are used under license. SYMBOL is a trademark owned by Symbol Technologies, Inc., which is a wholly owned subsidiary of Motorola Solutions, Inc. All other trademarks are the property of their respective owners. © 2013 Motorola Solutions, Inc. All rights reserved.

TABLE OF CONTENTS

Exhibit C-1

System Description	1
2.1 ASTRO 25 System Description.....	1
2.1.1 Overview	1
2.1.2 Upgrade to ASTRO 25 Release 7.15.....	1
2.1.2.1 System Topology	1
2.1.2.2 Master Site.....	1
2.1.2.3 Simulcast Cell	1
2.1.2.4 ASTRO 25 Repeater Sites	2
2.1.2.5 Subscriber Radios (mobile/portable)	2
2.1.2.6 Data Services	2
2.1.2.7 Network Management Subsystem.....	2
2.1.2.8 Coverage	3
2.1.2.9 Backhaul Network (Microwave).....	3
2.1.2.10 Dispatch Consoles	3
2.1.3 ASTRO 25 IP System Features	4
2.1.3.1 Master Site.....	4
2.1.3.2 Network Management System	4
2.1.3.3 Configuration Management Applications	10
2.1.3.4 Performance Management Applications.....	12
2.1.3.5 Integrated Voice and Data	16
2.1.3.6 Network Transport Subsystem	19
2.1.3.7 Information Assurance Elements (Optional)	19
2.1.3.8 System Access Features	22
2.1.3.9 Individual Call Features.....	24
2.1.3.10 User Accessibility Features	25
2.1.4 ASTRO 25 System Failure Mode Analysis.....	27
2.1.5 ASTRO 25 Infrastructure	28
2.1.5.1 Master Site Components.....	28
2.1.5.2 ASTRO 25 RF Sites.....	29
2.1.5.3 ASTRO 25 Component Descriptions.....	32
2.1.6 MCC 7500/7100 Dispatch CONSOLES	35
2.1.6.1 Interoperability Features	35
2.1.6.2 Integration with the ASTRO 25 Network.....	36
2.1.6.3 Console Operations	38
2.1.6.4 Console System Security	45
2.1.6.5 Console Configuration and Management	46
2.1.6.6 Interface with MetroSafe's Computer-Aided-Dispatch (CAD) System.....	47
2.1.7 MCC 7500 Dispatch Console Component Description.....	48



2.1.7.1	Operator Position Components	49
2.1.7.2	Auxiliary Inputs and Outputs	50
2.1.8	Microwave Network	50
2.1.8.1	Successful microwave frequency coordination is a critical path item	50
2.1.8.2	The 810 Barret Site will be eliminated from the ring	51
2.1.8.3	Microwave System Layout	51
2.1.9	Aviat IRU600 Eclipse Platform	52
2.1.9.1	ProVision Element Management System	54
2.2	VHF Paging	56
2.2.1	Simulcast System Component Descriptions.....	56
2.2.2	System Components	56
2.2.3	System Diagram	58
2.2.4	Assumptions	58
2.3	Fire Station Alerting	59
2.3.1	MACH Alert Component Descriptions	60
2.3.2	System Components	65
2.3.3	System Diagrams	66
2.3.4	Assumptions	67
2.4	WAVE Workgroup COMMUNICATIONS	68
2.4.1	WAVE Overview	68
2.4.1.1	WAVE Applications	68
2.4.1.2	WAVE System Components	70
2.4.2	Assumptions	70
2.5	Mutual Aid Analog Conventional Simulcast System IP Upgrade	71
2.5.1	System Components	71
2.5.2	System Diagram	73
2.5.3	Assumptions	73
2.6	Conventional Voting	74
2.6.1	System Components	75
2.6.2	System Diagram	77
2.6.3	Assumptions	77
2.7	Cutover Plan.....	78
2.7.1	Phase 1: Staging and Installation.....	78
2.7.2	Phase 2: Acceptance Testing	79
2.7.3	Phase 3: Cutover	79

SYSTEM DESCRIPTION

2.1 ASTRO 25 SYSTEM DESCRIPTION

2.1.1 Overview

ASTRO[®] 25 is the most widely used Project 25, Mission-Critical, Integrated Voice and Data (IV&D) communication network for public safety agencies. ASTRO 25 is a wireless platform that combines uncompromising, real-world performance and the legendary reliability of Motorola Solutions, Inc. (Motorola).

2.1.2 Upgrade to ASTRO 25 Release 7.15

2.1.2.1 System Topology

The current MetroSafe system will retain its current topology through the 7.15 upgrade with the following exceptions:

- The Simulcast Prime Site currently located at MICCS will be re-located to the Bardstown Rd site.
- This change enhances the availability of the simulcast cell by removing the dependency of the MICCS Prime Site on the Meidinger tower site. Please refer to the system diagram in the Section 3 of the proposal.

2.1.2.2 Master Site

Server Reduction and Virtualization

The number of physical servers at the Master Site has been reduced from nine down to two through virtualization. This allows a smaller system footprint, lower power/HVAC consumption, and simplifies installation.

2.1.2.3 Simulcast Cell

IP-Based Simulcast

The simulcast cell will be transitioned from a circuit-based (TDM/T1) architecture to an IP-based architecture.

Geo-redundant Prime Sites with Automatic Switchover

The Geo-redundant prime site feature provides two complete prime sites in separate geographic locations for redundancy. Switchover between the sites is completely automatic. Fault management of both sites is provided.

Relocation of MICCS Prime site

The current prime site located at MICCS is dependent on the Meidinger tower site for all connectivity to the 13 simulcast subsites. Relocating the prime site from MICCS to the Bardstown Rd site will



improve the availability of the prime site. Bardstown Rd also offers easier site access than Meidinger which is on the roof of a 2-story building.

Replacement of STR3000 stations

The (15) STR3000 base stations currently in use will be replaced with GTR8000 base stations. Parts and repair support for the STR3000 stations ended on 6/30/2014. A 4-port transmit combiner to support the 800 MHz mutual aid stations at the Waverly site is included.

Redundant Simulcast Subsite links

Each simulcast remote site will have redundant site links to maximize availability.

GGM8000 Routers

The S2500 Routers at the simulcast remote sites will be replaced with redundant GGM8000 routers.

2.1.2.4 ASTRO 25 Repeater Sites

The ASTRO 25 Repeater sites at New Bernheim, Jeptha Knob and LaGrange will only require a software upgrade to migrate to 7.15.

2.1.2.5 Subscriber Radios (mobile/portable)

Subscriber Firmware

MetroSafe's current mobile and portable subscribers will work on the 7.15 system without modification or reprogramming. MetroSafe's current subscriber software version (15.00.09) was released in May 2011 and aligns with ASTRO 25 system release 7.9. If MetroSafe desires to use new features that were released after May 2011, the subscriber software will need to be upgraded. Labor to upgrade the subscriber software is not included in this proposal.

2.1.2.6 Data Services

Customer Network Interface (CNI)

The CNI architecture between MetroSafe's IP network and the Motorola radio network will functionally remain the same. The CAD API, Genesis ATIA stream, NICE logger access for Inform and remote terminal access will remain the same.

Unified Network Services Server

The Presence Notifier server which provides information to client networks about the availability/addresses of mobile subscribers is replaced by the Unified Network Services server. This server performs the same function as the Presence Notifier while supporting other optional services such as personnel location, text messaging, database lookup etc.

2.1.2.7 Network Management Subsystem

Fault Management

The Unified Event Manager (UEM) replaces FullVision as the primary fault management application. MOSCAD will be upgraded. A separate OEM network manager (Aviat ProVision) is provided for the microwave network.

Network Management

The network management applications are all new and reflect current IT trends in network configuration management, tracing and accountability.

2.1.2.8 Coverage

The radio coverage will not change as a result of the migration from release 6.9 to 7.15 and the change from circuit based to IP-based simulcast. All radio sites will use the existing base station hardware and antenna systems with the exception of the 15 STR base stations that are to be replaced. A coverage acceptance test is not included in this proposal but can be quoted on request.

2.1.2.9 Backhaul Network (Microwave)

Microwave Radios (Aviat Networks)

A new microwave network with native IP and TDM support will be “overbuilt” on top of the existing OC-3 network. All of the functions that were previously handled by discrete pieces of equipment are now integrated into a single platform supported by a single vendor. Ethernet and TDM protection switching as well as hardware module redundancy and a network management terminal are included.

2.1.2.10 Dispatch Consoles

Increased Console Capacity and Flexibility

The console resource limit on the MCC7500 has been increased from 71 to 160 resources. The GUI offers more options for customization such as the color and size of different resources. Local console relay outputs are available. Optionally, the console can access up to 255 modes on an APX consolette with PTT-ID information. The basic design and operation of the GUI remains the same, minimizing dispatcher training requirements.

Redundant Site links

The three dispatch sites at MICCS will be equipped with redundant site links replacing the single site links in service today.

Replacement of MCC7500 GPIOM-based consoles with MCC7500 VPM-based consoles

The MCC7500 GPIOM-based dispatch positions will be replaced with MCC7500-VPM based positions. Each new position includes a PC with Windows-7, a Dual Instant Recall Recorder, (2) MCC7500 speakers, (2) headset jacks and (1) footswitch. Monitors are not included with each position but can be quoted upon request. The VPM-based console moves all audio processing to the VPM box and eliminates external hardware residing in the PC.

MCC7500/7100 Dispatch Site

A new dispatch site with redundant site links will be installed at a location TBD. . (20) MCC7100 Dispatch positions (Windows PC's not included) with a capacity license of 10 simultaneous/30 configured resources are included. Each position includes a single headset jack, footswitch and instant recall recorder and external USB audio interface box.

NICE Logging Recorder and Inform

The existing NICE MCC7500 IP logging recorder hardware and associated AIS will be replaced as part of this proposal. In order to access the recorder, NICE Inform will need to be at release 5.1 or

later. The upgrade of the NICE Inform product is not included in this proposal. Additional NICE channel licenses have been included to enable MetroSafe's Inform server to access recordings on the retired MCC7500 trunked radio logger during and after the cutover to the new system.

Conventional Channel Gateway Replacement

The (18) S2500 Conventional Channel Gateways located at MICCS will be replaced with (9) GGM8000 Enhanced High Density Conventional Channel Gateways.

2.1.3 ASTRO 25 IP System Features

An ASTRO 25 system is a feature-rich, modular platform that consists of a Core site, which may include ASTRO 25 RF sites and simulcast cells. This section discusses the various key features and equipment components that comprise the proposed system.

2.1.3.1 Master Site

The master site is the central point for all system traffic in each ASTRO 25 zone. Call processing and system management occur at the master site. The Voice and Data call processing for each zone is performed by the Zone Controller. The Zone Controller(s) maintain constant communication between the RF Sites, Simulcast Sites and Network Management (NM) sub-systems via the Network Transport Subsystem.

2.1.3.2 Network Management System

The Network Management (NM) system can be viewed as a set of software applications or tools used to manage the ASTRO 25 wide-area trunked radio system and its constituent components.

The NMS supports the following services:

- **Network Monitoring** – Applications are included for monitoring the status of the transport network and the individual infrastructure components; displaying status information; forwarding alert information; and performing diagnostic procedures.
- **Configuration Management** – Facilities are provided for entering and maintaining the operational parameters of the infrastructure components and user devices (i.e., the mobile and portable radios).
- **Accounting Management** – NMS supports the tracking of radio usage of the system by providing an optional interface to third-party accounting and/or billing applications.
- **Performance Management** – Standard and optional applications are available for monitoring, reporting, controlling, and optimizing the use of system resources.
- **Security Management** – NMS includes features for setting user privileges and controlling their access to view and/or modify information contained in the configuration databases.

The Network Management subsystem will include the following servers at the zone and system levels of the ASTRO 25 system.

- **NMS Zone-level Servers (one each per zone)** – Air Traffic Router, Zone Database Server, Unified Event Manager (UEM), and Zone Statistics Server
- **NMS System-level Servers** – User Configuration Server (UCS) and System Statistics Server

2.1.3.2.1 Unified Event Manager

The Unified Event Manager (UEM) application allows system management personnel to manage LMR system devices from a single screen. Historical and real-time traffic screens give users access to radio events, radio status, and any device alarms. Other features include:

- Graphical views/maps
- Active alarms and summary views
- External notification flexibility
- Remote site control
- Fault reporting capabilities
- Device inventory
- External notification
- Customized views
- Role-based access

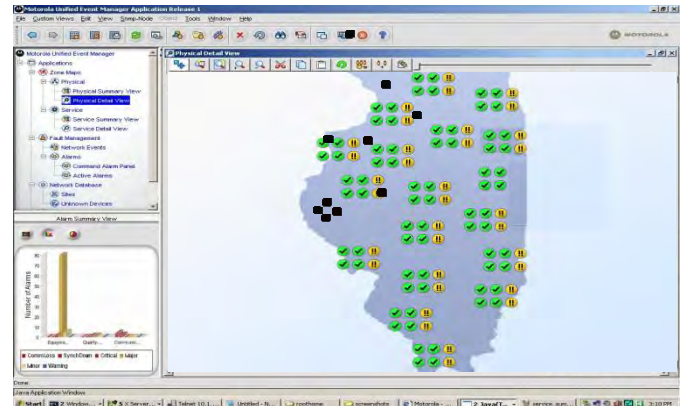

Sample UEM Screen

The UEM provides a customized discovery process for optimization and deep discovery of subcomponents reported on by a device.

The application also allows for automatic registration of the devices without pre-configuration. Interpreting and displaying events in an easy-to-understand and meaningful format—along with a topology of the network and devices tailored for the ASTRO 25 network—will ease navigation and present the network in a manner that is intuitive to a system operator.

Health of services is provided in addition to device-based alarms, including rules for determining the overall status of services in a separate service view (e.g., redundant controller is down – service is still up; we represent both views). Rules have been developed for calculating alarms based on interpreting incoming events. Security procedures are in place to roll SNMPv3 keys and maintain the ability to receive SNMP inform requests through the key role of an entire network. Device commands are presented in a manner specific to each device type. During discovery, a complete device inventory with specific rules to identify service and proxied components is accomplished for all individual devices. Table 0-1 outlines features and benefits of the UEM.

Table 0-1: Unified Event Manager (UEM) Features and Benefits

Feature	Benefit
Optimized Discovery Based on System Design	UEM supports subnet discovery of the IP addresses which are designated for radio system devices. This translates to an efficient device discovery process.
Discovery of Fault Managed Devices	Based on the device type the UEM has pre-determined rules for discovery of the custom entities supported on the device. Additional rules are used for event translation and alarm generation.
Fault Manager Registration	Procedures in place to register the manager's IP address as a trap/inform destination.
Centralized View of the Communications Network	System Managers can view the ASTRO 25 system status and quickly isolate problems to the board level.
Intuitive Graphical User Interface (GUI)	System Managers are quickly notified of failures on the system and can diagnose device problems. Summary and Detail maps provide a graphical display of site status in their geographical location within the system.

Feature	Benefit
Active Alarms View and Alarm Summary	Persistent single view of all failure conditions (“What’s Inoperable”) in the network and a quick reference summary of alarms by severity, allowing users to quickly pinpoint the highest priority failures.
Secure Device Access	SNMPv3 protocol with SHA and AES 128-bit encryption to prevent security breach attempts.
Role-Based Access Control	Assignment of user privileges for access to views and operational capabilities.
Email Notifications	User-specified event notifications are sent via secure email or forwarded to a portable mobile device, which allows System Managers to work away from the System Management Terminal but remain aware of system events.
Fault Reporting Capabilities	Event history data is auto-archived and exported for further analysis and reporting.
Remote Command Operation	Remote state change capability helps to service remote devices and avoid unnecessary trips to the sites for troubleshooting.
Network Inventory	Tabular view of the devices and their associated status.
Audit Trail and Job Status	Traceability and status for commands and actions executed.

The UEM is optimized to quickly discover the devices in our network—making installation and setup quick and error-free. The UEM has a built-in capability to identify the type of device it is discovering; it will activate the pre-determined rules for discovery of the devices, which results in faster event translation and alarm generation in the manager. Each device, via its various entities (i.e., fan, power supply, etc.), will quickly inform the manager what it needs to monitor. Procedures built into the UEM will configure the IP address in the device to give the correct path for sending its information during operation.

Quick and accurate interpretation of the system activity is crucial in effective management of the devices. The UEM translates the events into intuitive information, which will inform the user of either the severity of the failure or implication of the event.

UEM translates the events into active alarms, which make the user aware which events require immediate attention versus more minor events/alarms. The alarm view dynamically updates based on the condition of the reported device (i.e., the alarm will be cleared from the alarm view when a device sends a clear event to the UEM).

The Reliable Communication design in the UEM provides Supervision and Synchronization services:

- **Supervision** – Provides periodic SNMP Polling to ensure communication is established with each device on the network. The UEM generates communication failure alarms/events when communication between the agent and the manager fails.
- **Synchronization** – Used to ensure the accuracy of the state that the device is reporting. If the connection between the UEM and the device is lost, the device will queue up the missed fault events and re-send when the connection is re-established. These Motorola-defined procedures were put in place to enhance the reliability of basic SNMPv3 trap messaging. These procedures manage the re-synchronization of missed failures. The UEM utilizes SNMPv3 informs to enable the device to detect whether the connection has been interrupted.
- **Northbound Interface (NBI)** – A real-time event stream using a standard industry protocol that can escalate events to a higher-level management application for added flexibility. NBI is provided for customers who prefer to manage their network with existing tools. The UEM

handles the custom/proprietary interfaces to the network elements. The NBI provides a published fault event API to the customer's manager, which allows them to manage both Motorola and non-Motorola devices. The NBI agent supports SNMPv3 and uses a SNMPv3 User-based Security Model (USM) for secure communications with the UEM. The Fault Management Services provided with NBI are: Quick Synchronization – MOM requests more recent activity to update on health; File-Based Synchronization – Request to generate a file for missed information; and UEM-NMS Communication Link Supervision to notify of any interruption.

2.1.3.2.2 MOSCAD NFM System

The MOSCAD Network Fault Management (NFM) system is an end-to-end solution which collects alarms from devices and equipment at Motorola communication sites; then it sends the information to the Graphic Master Computer (GMC) server and UEM, where the information is stored so that it can be displayed and analyzed by system technologists and managers. Features and benefits of the MOSCAD NFM system are outlined in Table 0-2.

Table 0-2: MOSCAD NFM System Features and Benefits

Feature	Benefit
Collection of Environmental Alarms	A single SDM3000 supports data interfaces and digital alarm inputs to site equipment such as doors, tower lights, UPS, security, and third-party devices.
Data Interfaces to Site Equipment	The SDM3000 collects alarms and values from a wide range of Motorola stations, Microwave Radios, Channel Banks, Frequency Standards, and more via RS232, SNMP V1 & V3, and IP.
Collection of Analog Information	The SDM3000 interfaces to site equipment with analog outputs such as temperature sensors, fuel sensors, RF Power sensors, etc.
Initiation of Site Controls	The SDM3000 interfaces to site equipment which can be controlled, such as doors, generators, security, equipment switching, etc.
Local Web Server	The SDM3000 incorporates a built-in Web Server so that Service Technologists can view alarms of equipment and devices while on site or over the ASTRO network infrastructure.
Reliable Communications	The SDM3000 provides reliable communications to the GMC and UEM via encrypted SNMP V3.
Intuitive Drill Down Display of Alarms	The GMC incorporates an intuitive "Drill Down" display of alarms: Multi-Zone level, Zone level Map Screen, Site level, Device level, and Alarm level.
Intuitive Representation of Equipment	Chassis view graphics of the equipment are displayed on the GMC and GWS GUI, giving System Technologists an immediate understanding of the equipment and subcomponent which is in alarm.
Analog Display Screen	Graphical meters display the analog information of the site (i.e., Generator Fuel Level).
Equipment Control Screen	Equipment and devices can be controlled (turned On/Off, Open/Closed) from the control screen.
Immediate Update of Alarm Status	A combination of polling from the GMC and event reporting from the SDM3000 ensure alarm information is displayed on the GMC/GWS as quickly as possible.
Auto Archive of Alarms	Alarm information is automatically archived on the GMC server for future access by the Historical Alarm Report tool.
User-Defined Historical Alarm Reports	Historical Alarm data in the SQL database on the GMC can be easily accessed to produce reports with the Report Generator function.



Feature	Benefit
Multiple User Levels	Up to 8 user levels, ranging from Administrator to Guest, allow definition of operational capabilities from system configuration through system control to viewing and acknowledgment of alarms.
Alarm Summary Window	The Alarm Summary Window lists all time stamped alarms and can be sorted by Zone, Site, and Equipment, and by acknowledged/un-acknowledged alarms. This allows users to quickly identify any issues with their system.
Station Values Displayed	Station and Microwave values such as RSSI, BER, RF Power, and VSWR are displayed on the GMC/GWS, providing System Technologists with analytical information on the site they are troubleshooting.
Remote Configuration	A terminal window on the GMC/GWS allows remote configuration of analog QUANTARs and TeNSr Channel Banks.
Alphanumeric Paging of Alarms	The GMC/GWS can send specified descriptive alarm messages to alphanumeric-capable pagers over paging networks such as SkyPager or Skytel.
Client View of Multi-Zone System	Each GWS client can view alarms from each zone level GMC server, which minimizes the total number of clients needed in the system.

GMC Server and GWS Client

The MOSCAD NFM GMC server and GWS client is an NFM solution specific to Motorola communications systems. The NFM application graphic screens depict current system status; the user can easily navigate from a macroscopic system view down to the individual site details. RF site alarms are time stamped, stored in the alarm history database, and accessed by the Report Generator utility, which helps the user to filter alarms and events, then displaying, printing, and exporting them.

One GMC is required per Zone, and all the GWS clients (up to 16) view the real-time system alarms, status, and controls from all GMC servers.

GMC Server and GWS Client Graphics

The GMC/GWS NFM application has been developed to provide several layers of screens. The first layer is the System Overview Screen: a map showing the site locations with each site location icon selectable. The second screen layer is the individual site screen (Figure 0-1: Sample Individual Site Screen), graphically showing the exact equipment at each site with selectable equipment graphic icons. A third layer of screens is the individual site component hardware, such as GTR, Microwave, Rubidium standard, and other site support equipment, including environmental alarms. Alarm icons on the site equipment graphic show which module (i.e., Power Supply) is in alarm; selecting that icon provides a list of the alarms for that module. All alarms are also shown on the alarm summary screen.



Figure 0-1: Sample Individual Site Screen

SDM3000 Site RTU

The heart of the MOSCAD NFM solution is the SDM3000 site Remote Terminal Unit (RTU), where RF components and environmental equipment are alarmed and controlled. The SDM3000 interfaces to IP devices via SNMP and FSP, to monitor alarms and capture values such as RSSI, RF Power, and BER. The SDM3000 serially interfaces (RS232) to remote site devices by emulating the specific device protocol, allowing the SDM unit to control, collect alarms, configure, and change parameters of the device (Figure 0-2: Sample SDM3000 Screen). The SDM3000 collects alarms and initiates controls through the various inputs, outputs, and analog signals via the onboard Input and Output (I/O).

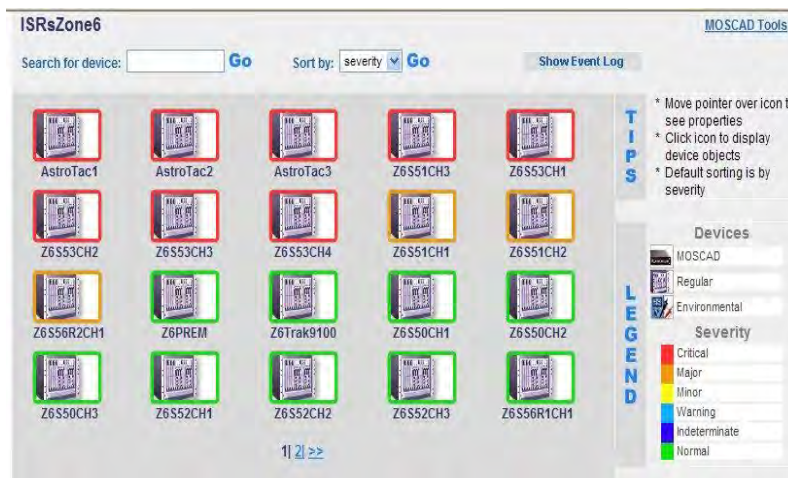

Figure 0-2: Sample SDM3000 Screen

The SDM3000 units take advantage of inherent communications capabilities to securely communicate via encrypted SNMP v3 from the remote sites to the UEM and GMC.

A built-in Web Server on the SDM3000 allows Service Technologists to use a browser to view alarms from all equipment and devices, while they are on site or remote over the ASTRO network infrastructure.

2.1.3.3 Configuration Management Applications

This section provides information about the applications that provide configuration management capability in ASTRO 25 systems. These devices are the Unified Network Configurator (UNC) and the Provisioning Manager (PM).

2.1.3.3.1 Unified Network Configurator

The Unified Network Configurator (UNC) is a network change and configuration management tool that enables users to efficiently manage the configurations of networks and devices in an ASTRO 25 system. The UNC is built on VoyenceControl, which is an automated compliance, change, and configuration management system. The UNC provides a single application for the configuration of all radio system and transport devices. Some of the key features that the UNC provides include:

- Efficient, role-based user setup
- Auto discovery of devices/configurations, reducing configuration errors and initial configuration time by providing minimal data entry

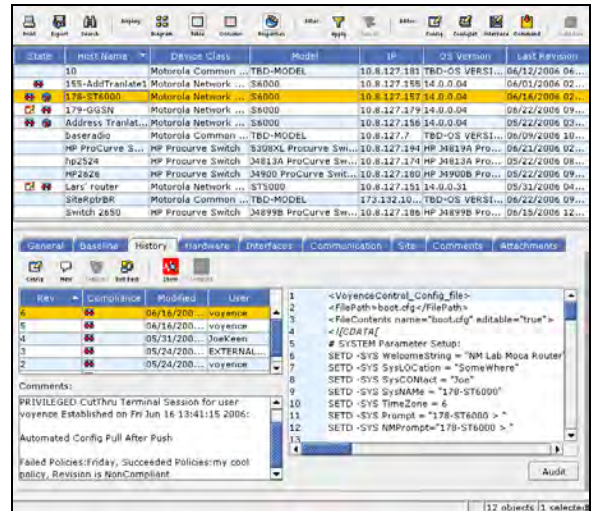

Sample UNC Screen

Historical configuration information is easily accessible, along with forensic information and the ability to roll back to previous versions. A valuable tool that the application provides is the ability to create a configuration and not implement it immediately. The UNC allows another user to approve and implement changes, which can help distribute those changes during off hours when system loading is minimal.

The UNC application allows system management personnel to see planned and current configurations simultaneously for quick comparison. This application offers easy editing screens and configuration “wizards” to reduce data entry.

Benefits of the UNC are outlined in Table 0-3:

Table 0-3: UNC Benefits

Feature	Benefit
Built-in Network Tool kit to enable features	Tools provide a methodical process to enable features in the system with minimal labor and chance of error. Examples of these are: turning on authentication on a set of protocols within the Gateways; locking Ethernet switch ports; setting delay; and jitter alarm thresholds.
Auto Discovery of Devices	Components are automatically discovered, and their configurations are added to the database without the need for any manual entry of data.
Scheduled Distribution	Users can determine the time of day when they would like configurations to be sent to the devices, or delay the distribution of a configuration change until approved.

Feature	Benefit
Distribution Monitoring	Allows users to view the status of configuration changes, such as whether the change is in progress, has successfully completed, or has failed.
Change Logging/Audit Trail	Maintains a log of various user interactions with the configuration system that can be used to help diagnose issues.
Configuration Versioning	Constantly tracks and logs versions that have changed and provides the ability to view or compare versions.
Management of Credentials	SSH and SNMP passwords can be managed. Automated mechanism allows seamless password and passphrase rolling, which can be performed automatically if desired.
Wizards for Common Operations	Radio system administrators can perform common operations using a simple web-based interface specifically developed for ASTRO 25 users. Provides an intuitive guide to assist in easy-to-follow setup procedures.
Rollback to Previous Version	Immediately reverts the device configuration to a previously created version.

2.1.3.3.2 Provisioning Manager

The Provisioning Manager (PM) is a centralized interface for all user and system configuration.

The PM provides the following:

- Configure system-level parameters for call capability.
- Configure system-level parameters for the master site, such as the parameters for home zone mapping and sub-band restricted ID mapping.
- Configure Console Users, Radios, Talkgroups, Multi-Groups, Agency Groups, and Broadcast Data Agencies.
- Configure access control for users in the PM.
- Configure ZoneWatch windows.
- Configure and manage the attributes relating to a zone such as MGEG Application Platform, Aux I/O Configuration, and Consoles.
- Ability to export some configuration data from the PM.
- Ability to import some configuration data to the PM.
- Optional API available to interface to the PM.

Features and benefits for the PM are outlined in Table 0-4.

Table 0-4: Provisioning Manager Features and Benefits

Feature	Benefit
Central Point for All User Configuration Information	Minimizes configuration conflicts created by multiple entry points. Enables simplified control and consistency for subscriber provisioning.
Radio User Capabilities	Efficient configuration capabilities across multiple agencies and system.
Reuse Configuration information Using Profiles	Minimize configuration data re-entry through the creation of profiles that are shared across several radio users and talkgroups.
Intuitive Navigation	Provides a tree-based navigation with objects arranged logically, allowing users to navigate to their required tasks.



Feature	Benefit
Fleet Management	Allows the user to easily create talkgroup and agency group mapping.
Agency Partitioning	Offers the ability to create security groups to partition system management resources among various agencies and users.
Concurrent User Access	Enables distributed configuration management from multiple users.
MCC7500 Console Information Synchronization	MCC 7500 consoles are automatically synchronized with radio user configuration information from the system, minimizing data entry and allowing for a cohesive view of configuration information.
Manage Configuration Data Distribution	Provides users with control over the distribution of configuration information to the various network devices in the system.

2.1.3.4 Performance Management Applications

The Motorola performance suite enables a customer to monitor, manage, and report on system performance in near real-time. The applications empower system managers to proactively plan for expansion. The performance suite is composed of both Motorola and third-party solutions that are all certified, sold, and supported by Motorola. Each application has a unique set of features and benefits to facilitate efficient and effective system management. Together, these applications complete the big picture: how the system is performing, operating, and being used, by providing insight into the activity of each zone, site, subscriber, or talkgroup.

Motorola offers performance management as a standard feature of ASTRO 25 systems. Other standard features include ZoneWatch, Historical Reports, and Dynamic Reports. These features enable customers to manage their communications system business more efficiently. ZoneWatch displays real-time communications activity, while Dynamic and Historical reports collect traffic statistics over predetermined intervals for report generation. These applications are used to monitor, collect, log, and evaluate network performance and resource utilization; they collect statistics about radio resource usage for radio units, talkgroups, channels, sites, zones, and system-wide activity report generation. Dynamic and Historical Reports have archival and export features for saving reports for offline data analysis. Statistics are aggregated into detailed and summarized reports on both an individual zone and system-wide basis.

Additionally, Motorola offers enhanced Performance Management features for ASTRO 25 systems, which are described below. Enhanced Performance Management features are available to provide further insight into system performance. Applications perform a variety of tasks, such as polling system resources, detailed reporting, long-term archiving and logging, and data stream collection.

Affiliation Display

Affiliation Display provides a dynamic view of the sites to which all operating units are currently affiliated; it suggests the area in which a unit may currently be operating based on its last affiliation and the site's radio coverage (Figure 0-3: Sample Affiliation Display Screen). The application enables system managers to monitor how radio users travel between different sites in a zone, and to monitor how they communicate with assigned talkgroup members and those outside of their talkgroup. Affiliation Display is used to trace a state/location of a single subscriber, and also to monitor location and affiliation information organized by site, console site, radio, channel, or talkgroup.

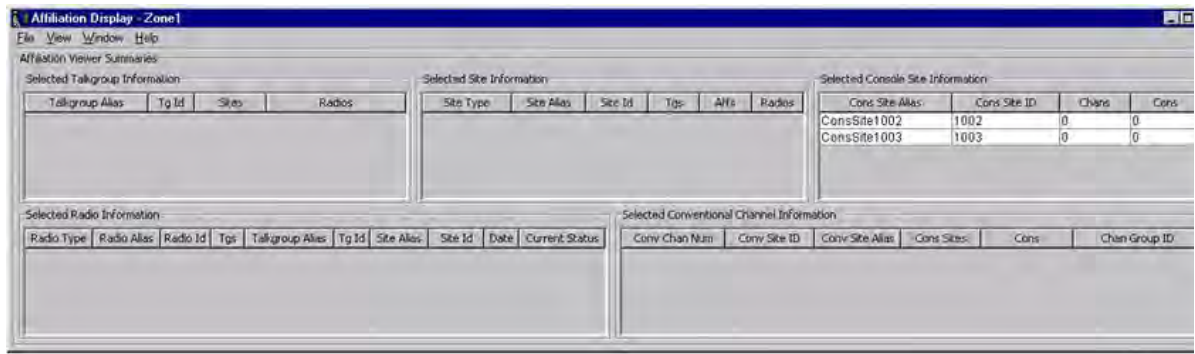

Figure 0-3: Sample Affiliation Display Screen

Table 0-5 outlines benefits of Affiliation Display.

Table 0-5: Affiliation Display Features and Benefits

Feature	Benefit
Real-Time Display	Monitor selected radios, sites, talkgroups, consoles, and conventional channels to track how radios are roaming between sites, and how traffic moves within sites in a zone. Display sites and console sites where each talkgroup is currently operating.
Graphing	Display graphs of the site, console site, and talkgroup data to see how radio usage is distributed across sites and talkgroups, to help determine if system resources are deployed to maximize system performance.

Air Traffic Information Access

The Flexible Air Traffic Information Access (ATIA) interface provides an access point for air traffic call information on the system. Whenever significant events occur in call processing, call information will be provided through ATIA. For non-call activity, the Flexible ATIA interface will provide call information in unique data packet formats. Benefits of ATIA are outlined in Table 0-6.

Table 0-6: Air Traffic Information Access Features and Benefits

Feature	Benefit
Integration Flexibility	ATIA stream data can be integrated with third-party applications to produce detailed reports custom built to a system manager's needs.
All Call Control Information	Information can be used to understand what is happening on the system, e.g., who called, where they called from, and type of call, to monitor the system's operation.

Computer Aided Dispatch Interface (CADI)

Computer Aided Dispatch Interface (CADI) is an Application Programming Interface (API) for use by third-party CAD applications, permitting customers to work with third-party vendors to create software that specifically meets their dispatch needs on Motorola ASTRO 25 systems. The API gives CADI direct access to the commands and events used by the radio system and its network management applications.

THIRD PARTY COMPANIES THAT HAVE INTERFACED WITH MOTOROLA'S CADI API

- ACIC client/server with Geocomm AVL server
- Archonix message switch
- Ather Biokey
- Cisco
- Customer-Created CAD:
 - Pinellas County, FL
 - Hanover County, VA
 - Prince Georges County, MD
- Fatpot CAD
- The Genesis Group
- Geo911
- INIT (Transit CAD Application)
- Interact
- Interact Field Based Reporting with CrimeAgent Client
- Intergraph
- New World
- Northrup-Grumman
- Orbital (Transit CAD Application)
- Ortivus AVL and CAD
- OSSI
- Premier MDC
- Tiburon Mobile and Forecom
- Trapeze
- Tri-Tech

Dynamic Reports

Dynamic Reports monitor and report usage trends in order to improve radio and talkgroup system management. System managers can closely examine what happens during a shift or set period of time: for example, checking the busy count to see if calls are being missed. Dynamic Report recommendations can be made on system expansion and design to improve communication.

Table 0-7 outlines features and benefits of Dynamic Reports.

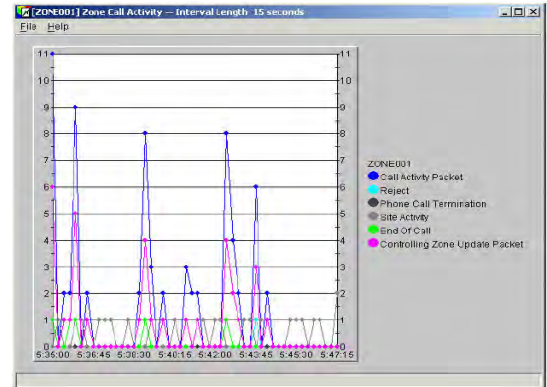

Sample Dynamic Reports Screen

Table 0-7: Dynamic Reports Features and Benefits

Feature	Benefit
Real-Time Display	This display provides zone-level, real-time line charts that illustrate channel utilization for all call types—group, private, interconnect, control channel, and dynamically blocked calls.
Graphing	Graphs can be run at the zone, site, and console site level to understand how often and why busy conditions occur on the system; this increases system efficiency and provides insight into how the system is being utilized.
Data Intervals	Dynamic statistical data objects are presented in time-based intervals. At the end of each interval, a new set of statistical values is added to the display. The timed intervals are defined as follows: 15 seconds (default), 1 minute, or 15 minutes for 1–100 intervals.
Accessing Data/Exporting Data	Reports can be output to the client PC workstation display, printer, or file for convenient access.
Data Storage	Statistics are aggregated into detailed and summarized reports on both an individual zone and system-wide basis. They are available on an hourly basis for 10 days, daily for 62 days, and monthly for 1 year.

Radio Control Manager

The Radio Control Manager (RCM) is used primarily by dispatchers to monitor and manage radio events, issue and monitor commands, and make informational queries of the system database. The RCM runs on a local PC client and, depending upon the configuration in the User Configuration Manager (UCM), can access multiple zones.



Table 0-8: Radio Control Manager Features and Benefits

Feature	Benefit
Radio Commands	<ul style="list-style-type: none"> - Regroup - Cancel Regroup - Selector Lock - Cancel Lock - Regroup and Lock - Cancel Regroup and Lock - Selective Inhibit - Cancel Inhibit - Storm Plan
Status Commands	<ul style="list-style-type: none"> - Radio check - Snapshot - Zone Status
Events	<ul style="list-style-type: none"> - Emergency Alarms - ChangeMe Requests - Status Events
Reports	<p>The RCM Reports tool is used to create, view, print, schedule, and export standard reports from RCM. These reports use a common format so the data can be used in spreadsheets.</p> <p>The report information reflects the actual RCM server database information, except the Emergency Alarms. RCM Reports enables you to present and analyze data showing RCM activity on the system.</p>

ZoneWatch

ZoneWatch is a performance management tool that has customizable displays and grids to monitor real-time communications activity in a single zone (Figure 0-4: Sample ZoneWatch Screen). The information displayed can help system managers become proactive in making better resource planning decisions, such as when additional channels need to be added.



Figure 0-4: Sample ZoneWatch Screen

ZoneWatch also receives fault information relating to repeater sites, console sites, and the zone controller from the UEM. ZoneWatch is used to monitor call traffic and allows the system manager to

organize displayed information using various criteria. Benefits of the ZoneWatch real-time display are provided in Table 0-9.

Table 0-9: ZoneWatch Features and Benefits

Feature	Benefit
Real-Time Display	Single Site View, Channel View, and Multisite view display all important radio call information. This provides the manager with insight about radio call activity, channel usage activity, and busy activity, to more efficiently manage the radio system.

2.1.3.5 Integrated Voice and Data

The Project 25–compliant Integrated Voice and Data (IV&D) operation allows data traffic to seamlessly utilize your existing ASTRO 25 stations, improving in-field efficiency. Voice is prioritized, allowing Mission-Critical traffic to always take precedence over data transmissions. The IV&D service creates a data transport layer capable of supporting both industry-standard IP and customer-developed applications, including:

- Advanced Messaging
- Outdoor Location
- Over the Air Programming (POP25)
- Over the Air Rekeying (OTAR)

Users can achieve a number of important benefits, including:

- Conservation of valuable airtime
- Increased communications accuracy
- Allows users in the field to perform queries without dispatch
- Better return on investment—same assets for multiple functions
- Utilizes common radio units for both voice and data applications
- Advanced Messaging Service—Similar to text messaging on a cell phone, the Advanced Messaging Service provides a convenient means of communication between all network users. A user can send a text message of up to 200 characters to another radio or dispatcher. Dispatchers and radio users may be a part of a named text-messaging group, allowing point-multipoint service. Advanced Messaging Service makes use of the IV&D transport layer, and provides a store and forward function, ensuring message delivery.

Packet Data Gateway

The Packet Data Gateway (PDG) is a modular platform designed to link the wireline IP Data Network to Motorola’s ASTRO 25 network.

The PDG software platform manages IP message traffic to and from the wireless network, supporting wide-area roaming. With wide-area roaming, data radios can roam seamlessly throughout the coverage area of the ASTRO 25 system without the need to select a different channel or have any specific knowledge of the RF network.

The PDG supports SNMP-based network management by providing detailed statistics and alarm information to monitor system activity and performance. These statistics and alarms allow you to monitor system operation and loading to support audit, diagnostic, and optimization activities using the SNMP-based standard. The information can be viewed directly via the PDG local console or through the Network Management System.

Motorola General Packet Radio Service Gateway Service Node Router

Motorola's General Packet Radio Service (GPRS) Gateway Service Node (GGSN) router provides for the interworking between the customer's network and the ASTRO 25 data system, allowing for independent management of IP addresses across networks.

The GGSN router handles the IP routing services in support of end-to-end IP data messaging. These services include Static and Dynamic IP addressing, IP fragmentation, and ICMP error reporting messaging for diagnostics and troubleshooting.

Outdoor Location Solution (Optional)

Motorola's ASTRO 25 Outdoor Location Solution is offered on the ASTRO 25 IV&D system using the VHF band, UHF Range 1, UHF Range 2, 700 MHz, and/or 800 MHz. It uses Global Positioning System (GPS) satellites to provide the location of personnel and vehicles; these locations can be fed to a map-based location application, providing dispatch operators with an invaluable tool for managing and tracking personnel and resources. The ability to locate users in a Mission-Critical situation dramatically increases user safety, while improving resource allocation and responsiveness.

Figure 0-5 shows an example of the main components for the Outdoor Location Solution.

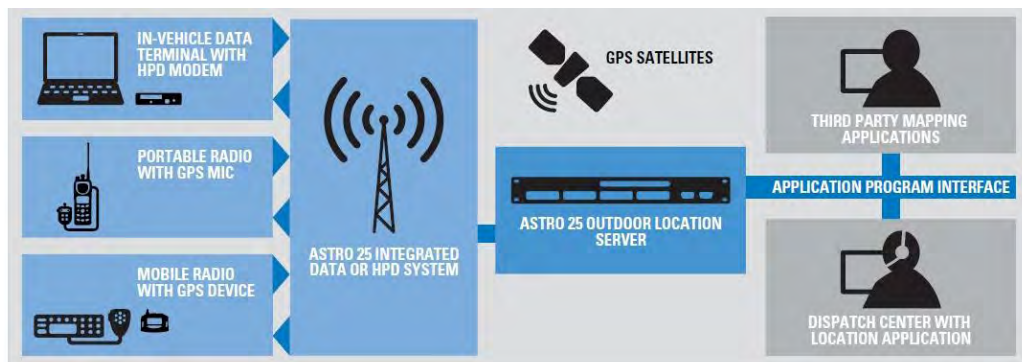

Figure 0-5: ASTRO 25 Outdoor Location Solution

Advanced Messaging Service (Optional)

Motorola's ASTRO 25 Advanced Messaging Service is an application that makes use of ASTRO 25 IV&D data services. Advanced Messaging Service provides the ability for users within the customer network to send and receive data messages of up to 200 displayable characters. These messages may be sent:

- From one text-messaging-capable subscriber to another text-messaging-capable subscriber.
- From a text-messaging-capable subscriber to a dispatcher equipped with a Fixed Text Messaging Client.
- From a dispatcher equipped with a Fixed Text Messaging Client to a text-messaging-capable subscriber.
- From a dispatcher equipped with a Fixed Text Messaging Client to other dispatchers equipped with a Fixed Text Messaging Client.
- From a text-messaging-capable subscriber to a third-party application having an e-mail address, where the third-party could be a messaging application such as CAD, Mass Notification System, database, etc.
- From a third-party application having an e-mail address to a text-messaging-capable subscriber.

All messages are routed through a central server in the Customer Enterprise Network (CEN). This server provides a store and forward service for the system, enabling storage of messages sent to an out-of-service user for subsequent delivery when the receiver becomes available.

Over-the-Air Programming

Programming over P25 (POP25), allows simple, wireless updates of LMR radios. This is an alternative to the standard method of programming, which is to connect a PC with a cable to the radio in order to read/write the programming changes. POP25 allows end-users and radio users to stay in the field during the reconfiguration process, thus saving valuable time and resources.

POP25 can reduce the total amount of time spent per radio unit update by up to 85%, allowing users and equipment to remain operational in the field. Assuming one reprogramming event every other year over the average lifetime of a radio (10 years), the total coordination and programming time can be reduced from 3.5 hours to only 30 minutes.

One of the key features of POP25 is being able to make and receive calls during the process:

- Retain full use of the radio during the configuration data transfer without interrupting communication
- Voice always takes priority over POP25 data transfers
- When a voice call ends, POP25 starts where it paused programming; there's no need to restart
- Users do not have to switch to a non-busy channel
- Users do not have to stay in an area with high signal strength during the download
- All radio functions and capabilities are accessible and enabled

POP25 allows for scheduled batch programming and can make specific programming changes instead of requiring a full code plug rewrite. The system will automatically generate a report, showing which radios were successfully programmed. An overview of the OTAP process is shown in Figure 0-6.

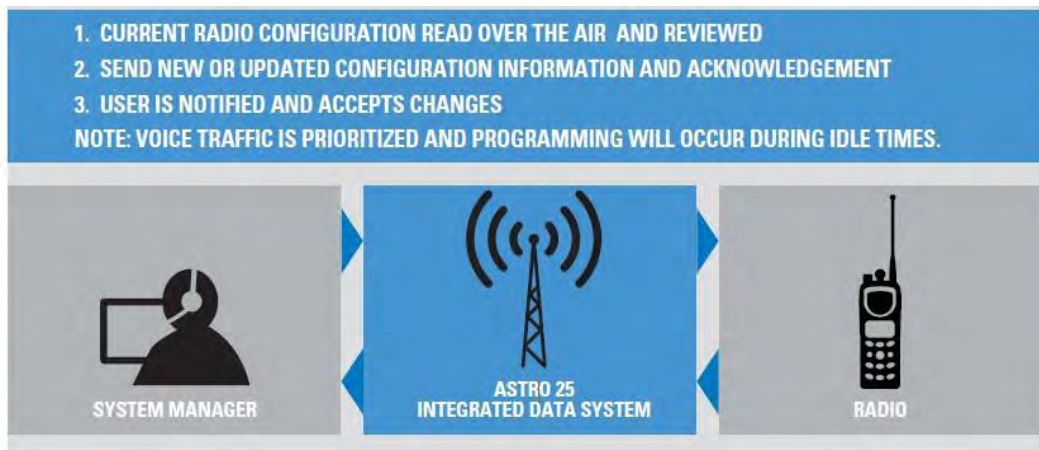

Figure 0-6: Over-the-Air Programming Steps

Over-the-Air Rekeying (Optional)

Digital encryption helps keep your communications secure. Over-the-Air Rekeying (OTAR) is enabled via Motorola's FIPS 140-2 certified Key Management Facility; this allows system operators to easily and securely change encryption keys on a regular basis, making the keys a moving target, and thus more difficult for adversaries to crack. If one of the radios is compromised, you have the ability to:

- **Remote inhibit** – Securely prevent radios from gaining access to the network from a distance.
- **Remote enable** – Securely re-establish a radio's network access from a distance.



- **Zeroize** – Securely remove a radio’s key material.
- **Change-over** – Securely switch a radio’s keyset to another keyset for use.

OTAR, like POP25, sends updates to radios over the air, so users do not have to bring their radios in for manual service. This is especially important for encryption keys, because a manual change out could take days or weeks to accomplish — meaning lost money and productivity, as well as a longer window of vulnerability.

2.1.3.6 Network Transport Subsystem

The ASTRO 25 transport core is engineered to meet the performance requirements of a real-time system transporting voice, call control, network management, and ancillary network services. The Transport Network is a closed network. Only Motorola-supplied equipment, applications, and services can be used on the network.

Ethernet Switch

The Enterprise Ethernet Switch (LAN Switch) is used to aggregate all the Ethernet interfaces for all servers, clients, and gateways.

Cooperative WAN Routing

The Motorola Cooperative WAN Routing (CWR) solution allows core and exit routers to interface directly with RF sites, network management sites, console sites, and inter-zone links.

The CWR solution has the following advantages:

- Provides redundant router failover capabilities
- Allows for easy configuration, testing, and maintenance
- Minimizes downtime during upgrades

The CWR consists of:

- **Core Gateways**— perform the routing control of audio and data in and out of the zone, while achieving the fast access levels required by real-time voice systems.
- **Gateway Routers**—used for devices that are multicasting beyond their local LAN, such as to IV&D and High Performance Data (HPD) packet data gateways.
- **Exit Gateways**—routers that handle InterZone links.

Redundancy

To ensure system availability, the Transport Network provides:

- Redundant Ethernet switches
- Redundant routers

2.1.3.7 Information Assurance Elements (Optional)

The integration of Information Assurance (IA) is another step towards continuing enhancement, ensuring these mission-critical networks remain operational so users can do their jobs better and more efficiently.

The next several paragraphs explain some of the processes, hardware, and software that can be implemented with an ASTRO 25 system. We will work closely with your security team to ensure this system experiences minimal disruption due to outside sources. The following sections list several of the key services that are provided in our IA package.

Router Access Control List

The Router Access Control List feature provides basic packet filtering capabilities provided by routers. A router's primary function is to route traffic. Routers are not designed to provide the fine grained packet inspection that firewalls typically provide.

TCP/IP traffic filtering is employed at core, exit, gateway, and site routers to enhance the security of the network. The security enhancement is realized by only allowing traffic for a combination of predefined subnets, hosts, and protocols. All other traffic not defined in the Router Access Control List is dropped by the router. Some examples of traffic that would be dropped by the router may include traffic to/from illegitimate IP address, some known insecure protocols, and specific port numbers that support known Denial of Service attacks. The Access Control Lists employed on the routers are configured with a "deny-by-default" policy. This policy forces the router to drop packets that have not been explicitly defined as allowed.

Centralized Authentication

Centralized Authentication provides one control point for identification, authentication, and authorization services. Authentication is proving who you are. Authorization is what you are allowed to do once you are determined to be authentic. Authorization can define what functions and operations user can perform, and on what devices. Accounting is the paper trail. Accounting is included in this feature and a limited authorization implementation is also part of the feature. It also addresses identity management within the ASTRO 25 network through a centralized user credentials (account and password) database. Identity management includes the management of user accounts, contact details of user accounts, and system user accounts. A Centralized Authentication subsystem consists of a group of computers, which uses or offers services to organizational units for the purpose of administrative and policy management.

Router Encryption with OSPF/BGP and PIM-SM

The router encryption feature uses an AES 256 bit encryption algorithm for all voice and data packets between RF sites and the zone core, NM/Dispatch sites and the zone core, GGSN and border router, and InterZone links such that all packets traveling through these WAN links provided by a public network service provider to the customer will be encrypted. An encryption capable router uses a hardware encryption module.

The current implementation of this encryption feature uses a Pre-Shared Key (PSK) to authenticate each peer router. This PSK can be periodically changed to enhance the network security in accordance with MetroSafe's security policy. MetroSafe policy includes who is authorized to change the PSK, how often the PSK must be changed, the current PSK being used for each link, etc. Motorola router encryption provides a capability to use the same PSK to all links, some of the links, or only to a single link. It is up to the MetroSafe's security policy to define the usage of PSK. A PSK can be 1 to 111 octets in length. FIPS 140-2 compliance recommends a minimum of 10 octets. Each octet in a PSK can be of any ASCII characters.

The OSPF/BGP (Open Shortest Path First / Border Gateway Protocol) are IP routing protocols which are used along with PIM-SM (Protocol Independent Multicast - Sparse Mode) enhancements to provide authentication between peer routers that use these protocols by means of the Pre-Shared Keys.

Ethernet Switch Port Security

The Ethernet Switch Port Security feature of the proposed ASTRO 25 system for MetroSafe utilizes two methods: MAC Port Lockdown and 802.1x capability for Service Ports.

The MAC Port Lockdown feature provides a layer of security at the physical location of the equipment. MAC Port Lockdown prevents unauthorized access to the system via ports on a network switch by locking each port to one or more MAC addresses. Access to the system via a locked port is denied to any devices with MAC addresses not matching the address(es) locked to that port. Information sent to the locked address cannot be hijacked and directed out to the port of an intruder. MAC Port Lockdown also controls address learning on the switch, which prevents station movement at remote sites.

The 802.1X feature is added to the GCP 8000 Ethernet service port and may also be added to HP switches when a service port is desired. The IEEE 802.1X standard defines port-based, network access control that is used to provide authenticated network access for Ethernet networks. Port-based network access control uses the physical characteristics of a switched LAN infrastructure to authenticate devices that are attached to a switch port. The ability to send and receive frames using an Ethernet switch port is denied if the authentication process fails.

Centralized Event Logging

The Centralized Event Logging Services feature allows central collection of system events from logging-enabled devices in the ASTRO 25 network. Because of the industry need for increased security, all devices sold by Motorola will have built in logging functionality. As a result, there may be potentially hundreds of logging-enabled devices in a large ASTRO 25 system. Thanks to a centralized mechanism for collecting event logs, network and security administrators are able to manage and review log file information without having to access every network element individually. It provides customers with an accepted IT industry standard solution for collecting and managing system information at a central repository.

The recording of system information is needed to establish accountability for system events and for the actions of system entities that cause them. Logging of system events creates an audit trail by providing evidence of access control, change management, and accountability, which can support the detection, and subsequent investigation of security breaches.

Zone Core Protection

Zone Core Protection (ZCP) is a feature that provides the hardware and software necessary to protect the Radio Network Infrastructure (RNI) from potential attacks that originate from Remote Sites or the communication links that Remote Sites utilize.

The ZCP feature provides TCP/IP traffic filtering in the ASTRO 25 Radio Network Infrastructure to enhance the security of the network. The traffic filtering is implemented by Stateful Packet Inspection firewalls. This security enhancement is realized by only allowing traffic for a combination of predefined subnets, hosts, and protocols. All other traffic not defined as valid for the ASTRO 25 network is dropped by the firewall. Some examples of traffic that would be dropped by the firewall may include traffic to/from illegitimate IP address, some known insecure protocols, and specific port numbers that support known Denial of Service attacks.

The firewalls implemented by the ZCP feature are configured with a “deny-by-default” policy. This policy forces the firewall to drop packets that have not been explicitly defined as allowed. ZCP provides traffic filtering specifically between the Master Site and Remote Sites, and between different zones. A pair of firewalls is introduced by the ZCP feature to provide this traffic filtering. Pairs of Ethernet LAN switches are also introduced to provide connectivity between the firewalls and the associated core and exit routers. These LAN switches, referred to as Mediation LAN switches, also provide connectivity for an optional Centralized Logging Server and traffic monitoring points. These firewalls and switches are deployed in redundant pairs to allow the feature to operate with a single component failure.



Service Access Architecture

The Service Access Architecture feature provides secured communications access between the Radio Network Infrastructure (RNI) and service users. The feature can be viewed as four primary access scenarios as follows:

1. Access to the RNI from Motorola System Support Center via dedicated WAN connection
2. Access to the RNI via dial-up connection provided by modem located in the DMZ (the service user for this scenario may be Motorola service users or customer based service users)
3. Access to the RNI via dial-up connection provided by modem located at Simulcast Prime Site (the service user for this scenario may be Motorola service users or customer based service users)
4. Access to the RNI via LAN switch located at a remote site (the service user for this scenario may be Motorola service users or customer based service users)

These scenarios provide access to services for the service user such as remote control of devices, diagnostics, file transfer, security monitoring, and fault management. Secure remote access to these services allows a reduction in cost for maintenance of the radio network and reduced response time for issue resolution.

Securing Protocols with SSH

The ASTRO 25 system consists of many components that communicate with each other using a variety of standard protocols. Many of these protocols are not secure. This creates a serious risk to the network. There are various levels of risk associated with different protocols. The highest risk is administrative type of protocols that pass authentication parameters (i.e., passwords) in the clear. Capturing this information by sniffing the network can lead to unauthorized access to a device, which constitutes the most severe compromise of data and network security.

Secure Shell (SSH) addresses this threat by providing secure alternatives for clear file transfer and r-command protocols. Specifically, the following clear protocols (non-secure protocols) are replaced: telnet, FTP, TFTP, rlogin, rsync, rcp, and rsh. The use of the targeted clear protocols, currently used in our systems, is prohibited in certain portions of the public-safety radio market. The reduction of clear protocol usage is necessary to sustain Authority to Operate (ATO) certification for U.S. federal systems and is increasingly identified as a mandatory system requirement for non-federal systems.

SSH provides a secure point-to-point connection between two different machines where the connection is encrypted and both ends have been authenticated. Many elements in the ASTRO 25 system will utilize this capability for secure communications.

Radio Authentication

ASTRO 25 Radio Authentication provides a mechanism that allows a radio to prove that it is genuine and therefore can utilize the trunking system. It is based on the P25 TIA 102.AACE Link Layer Authentication standard; it can be incorporated on existing ASTRO 25 systems and most ASTRO 25 radios, and it allows P25 radios from other vendors to use the feature. Systems without the optional Radio Authentication feature are susceptible to cloned and otherwise unwanted radios on the system. Radio Authentication prevents these unwanted P25 radios from successfully unit registering, thus preventing them from using the services of the system. Unregistered radios cannot listen to calls, place calls or otherwise disrupt MetroSafe's operations.

2.1.3.8 System Access Features

To ensure system access, simplify radio operation, and limit operator involvement, the ASTRO 25 platform has many access features, as described below.

Busy Queuing/Call Back

This system has been designed to maximize availability to the end-user. In the unlikely event that all the channels are busy, a user depressing the Push-To-Talk (PTT) will be given a busy signal, and placed into a busy queue. When a channel becomes available, the system assigns the users to a channel via pre-assigned priority levels. Once a channel is assigned, the system notifies the user with a call back tone. This feature makes it unnecessary for the radio operator to waste valuable time rekeying the radio in order to gain channel access.

Automatic Retry

If a channel request is not received at the Zone Controller, the individual radio unit continues sending channel requests until the Controller acknowledges the request, or until a total of 16 automatic retries occur. This feature eliminates the need for the operator to continually key and de-key the radio, or to keep the radio keyed in order to gain system access.

Recent User Priority

To ensure uninterrupted communications, a recent radio user priority provides those users who have been recently assigned a voice channel priority over the other system users. Recent user priority ensures that a talkgroup engaged in a conversation receives priority system access for up to 10 seconds between transmissions.

Misdirected Radio Protection

To ensure a radio from one talkgroup cannot accidentally be assigned to a voice channel being used by a different talkgroup, the system utilizes embedded signaling. If a unit from a different talkgroup is accidentally assigned the same channel, the radio will recognize that it has been assigned incorrectly, and will automatically revert to the control channel.

Continuous Assignment Updating

Once a talkgroup is assigned a voice channel, the control channel continues to transmit the channel assignment for as long as that talkgroup is using the channel. This ensures a radio just coming into service will be sent to the appropriate voice channel to join the rest of its talkgroup.

Talk Prohibit Tones

In the event a user attempts to perform an unauthorized function as defined by system permissions, a talk prohibit tone is given.

User Talkgroup Features

To enhance user functionality, the ASTRO 25 platform has many talkgroup features, also known as group call, as described below. These features are configurable by the System Administrator.

Emergency Alarm/Call

Emergency alarm/call provides users the capability to inform dispatch personnel of a life-threatening situation. By pressing the radio's emergency alarm button, an audible and visible alarm and the user's ID is sent to the dispatcher and, potentially, other talkgroup members.

In emergencies, the dispatch center is notified immediately, regardless of whether the system is busy. If one or more voice channels are available, one of those channels will be assigned immediately to the emergency call when the user presses the PTT switch. The duration of the emergency call can be defined by the system administrator.

In the event that the system is busy, two alternatives are provided for handling emergency traffic:

- **Top of the Queue**— When an emergency is initiated and no channel is available, the emergency user is put at the top of the busy queue. As soon as the first user on any channel de-keys, the emergency caller is assigned that channel. The major advantage to this approach is that there is no contention for the channel.
- **Ruthless Preemption**— When an emergency is initiated and no channel is available, the Zone Controller selects the channel assigned to the lowest priority user and assigns it to the emergency caller—a feature unique to Motorola trunking systems.

Multiple Priority Levels

The system provides 10 priority levels, allowing administrators to segment their users according to their communications needs. Priority 1 is always reserved for emergencies. Priorities 2 through 10 can be assigned by the System Manager on a per radio or talkgroup basis. These priorities are only applicable when the system is busy.

Multi-Group Call

Multi-group call is used to make a simultaneous call to multiple talkgroups, and allows all units to be configured for talk back capability. The System Manager can program this call to operate in one of two ways:

- The requesting user waits for all requested talkgroups to finish all calls in progress.
- The requested call immediately interrupts other conversations in progress without waiting for active users to de-key. Radio users who are transmitting on a voice channel will not hear the call until they de-key.

Priority Monitor

Priority monitor allows the radio user to scan talkgroups in their system, and mark up to two talkgroups in their scan list as Priority. A non-priority conversation will be interrupted by Priority 1 or Priority 2 talkgroup activity.

Dispatch Console/Talkgroup Merge

Talkgroup merge is a dispatch function that allows multiple talkgroups to operate together on one voice channel, improving channel efficiency. This is a standard feature of Motorola wireline consoles.

2.1.3.9 Individual Call Features

To further enhance user functionality, the ASTRO 25 platform has individual call features in addition to user talkgroup features, as described below. These features are configurable by the system administrator.

Call Alert

Call Alert allows a dispatcher or radio user to selectively page an individual's radio. Call Alert signaling is conducted over the control channel and does not affect voice channel capacity. The Call Alert produces an audible and visual alert on the receiving radio. Indicators on the initiating radio acknowledge delivery of the Call Alert. If the receiving unit has a display, it will show and store the sending unit's ID.

In-Call User Alert

In-Call User Alert is a feature that builds upon Call Alert. When In-Call User Alert is enabled on the system, radios will be able to receive Call Alerts even when involved in voice and data services.

Radio Talkgroup Muting

Radio Talkgroup Muting is a feature that utilizes the Call Alert feature. Radio Talkgroup Muting allows the radio user to mute all voice traffic for the currently selected talkgroup.

The radio can be automatically un-muted by the console dispatcher or another radio user by sending the muted radio a Call Alert. With In-Call User Alert enabled, the Call Alert will reach the muted radio when it is on the voice channel or a data channel, as well as if it is idle on the control channel.

Private Call

Private Call allows a radio user or console dispatcher to selectively call and carry on a private conversation with another individual radio, as long as that unit is not already engaged in another Private Call. The calling unit will receive an acknowledgment of a successful Private Call. If the receiving radio has a display, it will show the calling party's unit ID.

Telephone Interconnect

The telephone interconnect feature allows selected radios to make and receive phone calls. Telephone interconnect provides a temporary connection to a landline telephone through the radio system. Telephone interconnect allows radio users to call a telephone number from the field.

2.1.3.10 User Accessibility Features

Affiliation Display

The Affiliation Display provides a dynamic view of the sites to which all operating units are currently affiliated, making it easy to track and troubleshoot radios in the system. Specifically, it provides a dynamic view of:

- Sites
- Talkgroups
- Individual radios

This allows a manager to understand the loading characteristics of their system in real-time. Graphing capabilities are also included. Figure 0-7: Selected Site Graph Example provides a selected site graph example.



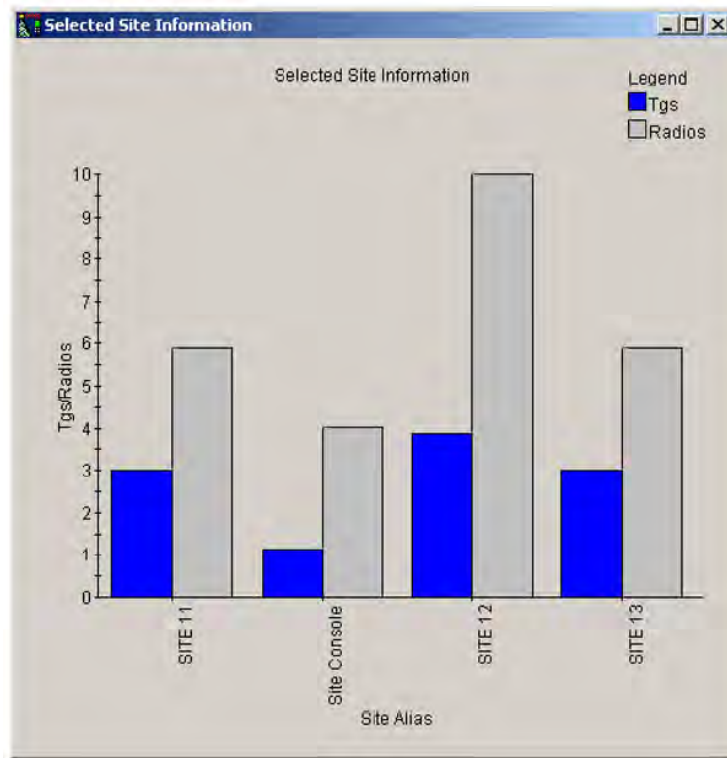

Figure 0-7: Selected Site Graph Example

SNMP Trap Forwarding (Optional)

SNMP trap forwarding allows for the forwarding of alarms from the UEM application to an external third party application utilizing an industry standard protocol (SNMP v3 management system). This feature permits your existing network to actively monitor alarm conditions within the radio network; a developer's guide is provided.

Channel Partitioning (Optional)

The Channel Partitioning feature provides agencies or departments, with exclusive use of specific RF channels. The use of this feature allows the segregation of one set of users from another to ensure dedicated resources for a specific group.

Dynamic Frequency Blocking

When frequencies are sparse, Dynamic Frequency Blocking allows users to reuse frequencies in close proximity within the system. This feature automatically allows the system to dynamically block the frequency at site A while transmitting the same frequency at site B.

Northbound Interface (Optional)

Forwards alarms from the Unified Event Manager (UEM) application, allowing your existing network to actively monitor alarm conditions within the radio network.

Email Alerting (Optional)

Email alerting sends notifications for system alarms in the UEM to a specified email address. Alarms can also be forwarded to a mobile device such as a cell phone or PDA.



2.1.4 ASTRO 25 System Failure Mode Analysis

Motorola's ASTRO 25 trunking networks have three modes of operation for increased reliability. The normal mode of operation is wide-area trunking. In the event of multiple component failures that lead to system disruption, the system is equipped to continue operation in two reduced feature operational modes: site trunking and failsoft.

The following pages include a detailed description of each of these operational modes, as well as a comprehensive analysis of the possible infrastructure failure scenarios and the system redundancy for mitigating each scenario.

Wide-Area Trunking

Wide-area trunking is the ASTRO 25 system's normal mode of operation. Wide-area trunking implies that the Fixed Network Equipment is operating properly. All simulcast cells and ASTRO 25 repeater sites are communicating with the Master Site. Subscriber units automatically roam between the various network RF cells. Talkgroup calls occur in the appropriate RF cells if users are distributed throughout multiple cells. Data applications are properly assigned channels for communication between the subscriber units and the host application.

Site Trunking

Site trunking is the first failover mode of operation. Site trunking impacts individual RF cells within a network. In multiple RF cell systems, one RF cell can be in site trunking, while the rest of the system remains in wide-area trunking. Site trunking implies that the simulcast prime site controller or the ASTRO 25 repeater site has lost connectivity with the Master Site. Talkgroup calls initiated in the RF cell that is in site trunking will only be broadcast in that RF Cell. Dispatch consoles use control stations, or the operators use portable radios to communicate on a site trunking RF cell. Console priority is not available in site trunking. Data applications are not available on a site in site trunking and will have to be reinitiated once the system reverts to wide-area trunking.

Radios detect if a site is in wide-area trunking or site trunking. Radio models with a display will indicate to the user when the site is operating in site trunking. The radio alternately displays the selected talkgroup and "Site Trunking." Depending on how the system and user equipment are programmed, subscriber units will try to roam to an RF cell that is in wide-area trunking.

Failsoft by Talkgroup

Subsystem/site failsoft is the final fallback means of communication if a site no longer maintains wide-area or site trunking operation. Multiple failures have to occur for the system to enter failsoft. Failsoft impacts individual RF cells within a network. In multiple RF cell systems, one RF cell can be in failsoft, while the rest of the system remains in wide-area trunking. The subsystem goes into failsoft mode in any of these scenarios:

- The site controllers are not functioning properly
- When all control channels are disabled or malfunctioned
- When only one channel is enabled

Failsoft operation provides communications in conventional mode via repeaters/base radios in order to maintain vital communications. In an IP multi-site simulcast subsystem, in subsystem-wide failsoft, received audio is routed to the comparator for voting and redistributed to all of the sites for simulcast transmission.

The subscriber's operation in failsoft mode is determined by the subscriber's programming. A subscriber can be programmed to behave in the following manner:

- **Failsoft by control channel operation** – The subscriber first scans for alternate control channels outside the multi-site subsystem, then scans the control channel frequencies for failsoft data.
- **Failsoft by working group** – The subscriber looks for Failsoft data on a pre-programmed frequency after a scan for alternate control channels outside the multi-site subsystem is unsuccessful. If the subscriber cannot decode failsoft data on the pre-programmed frequency, the subscriber then scans the control channels in the simulcast subsystem for failsoft data.

Subscriber units in an RF cell that is in failsoft will try to roam to an RF cell that is in either wide-area trunking or site trunking. Dispatch consoles use control stations or the operators use portable radios to communicate on a site trunking RF cell. Console priority is not available in site trunking. Data applications are not available on a site in failsoft and will have to be reinitiated once the system reverts back to wide-area trunking.

Simulcast Local Failsoft

This feature addresses two simulcast subsystem failure scenarios, prime site to sub-site link failure and prime site failure:

- Upon loss of communication (11 seconds or more) with comparators due to a sub-site link failure, the GTR 8000 Base Radio, when programmed with local failsoft “on,” will automatically enter in-cabinet repeat mode and continuously transmit Failsoft signaling. Link failures of less than 11 seconds or more will not trigger a link failure condition.
- Provides continuity of operations within the coverage area of a simulcast sub-site, in case of loss of connectivity with Prime site, through local in-cabinet repeater mode operation. Prior to this feature, a prime site connectivity failure would cause the sub-site to be non-operational.
- This feature does not provide logic inputs to override and control this functionality, as was implemented on QUANTAR in SmartZone and SMARTNET systems. There is a change request in progress to enable this capability.
- TDMA-based systems will revert to FDMA conventional operation during local Failsoft.

2.1.5 ASTRO 25 Infrastructure

2.1.5.1 Master Site Components

A zone has a master site that contains the computing backbone for that zone. The master site contains all the components necessary for controlling calls within a zone and for communicating with other zones to manage InterZone calls in a multi-zone system. In addition, the master sites provide the hardware and software components that are used for Network Management and system configuration.

All the components that communicate over Ethernet are connected through a central switch called the master site Ethernet LAN switch. This switch provides two separate internal LANs which are integrated to provide redundant links for critical network traffic.

The zone controller is used to process system-wide commands and handle call processing and mobility management functions for the system. In systems with two zone controllers, there is a connection from each zone controller to the LAN switch and a direct connection between the two zone controllers. The LAN switch connection allows each zone controller to communicate with the gateway routers/Core Gateways.

2.1.5.1.1 Zone Controller

The Zone Controller provides trunking call processing for ASTRO 25 system operation. The Zone Controller forms the heart of a wide-area radio system by providing the central processor for the zone,

with the necessary hardware and software capabilities to provide call processing and mobility management.

The Zone Controller builds upon the strength and experience of Motorola wide-area trunking systems to deliver multiple layers of reliability for business-critical, Mission-Critical and life-critical applications.

RELIABILITY THROUGH REDUNDANCY

The Zone Controller is supplied in a redundant controller configuration, and provides the following:

- **System Availability** – The Zone Controller allows software upgrades once loaded, providing enhanced system availability.
- **Intelligent Switchover** – The Redundant Configuration provides automatic switchover to the standby controller if a loss of wide-area communications is detected. Notification can be sent to the user if other components fail, allowing the user to manually switch to the standby controller if desired.
- **Cross Controller Compatibility** – Capable of running two different versions of software simultaneously, ensuring upgrades are fully functional with one controller before upgrading the second controller.
- **Redundant Configuration** – The Redundant Zone Controller is a computer platform with redundant processors that provide trunking call processing for ASTRO 25 wide-area radio communication systems. It is designed to detect failures by automatically switching operation to the standby controller, minimizing the interruption of call processing functionality.

2.1.5.2 ASTRO 25 RF Sites

ASTRO 25 RF sites provide communications for radio users both inside and outside the ASTRO 25 network. RF Sites may include ASTRO 25 repeater sites, simulcast cells, High Performance Data (HPD) RF sites, and ASTRO 25 conventional channel sites.

The RF Site types applicable to this system design are described briefly in this section.

Repeater Sites

An ASTRO 25 Repeater Site consists of a single site with up to 28 channels and two site controllers (in a redundant configuration), which can be standalone or housed in a GTR 8000 Expandable Site Subsystem (ESS).

The GTR 8000 Expandable Site Subsystem in a repeater site is set up in a single trunked site, with one active control channel and a number of voice channels at the site. If packet data services are supported at the site, a number of voice channels can be configured with packet data channel capability. Voice traffic is routed from each of the base radios to the system for distribution to other sites and is repeated by the base radios to support other local subscribers. However, data traffic is

routed to the GCP 8000 Site Controller. The site controller routes these packets upstream to the zone controller for further processing and routing.

The ASTRO 25 Repeater Site consists of the following components, described in the Component Descriptions section of this System Description.

- GTR 8000 Expandable Site Subsystem (ESS)
- GTR 8000 Repeater/Base Radio
- GCP 8000 Site Controller
- Radio Frequency Distribution System (RFDS)
- Sub-Site Ethernet Switch
- GGM 8000 Site Gateway

Simulcast Sites

A simulcast land mobile radio system provides continuous coverage over a large geographic region using a single set of frequencies. Simulcast solutions extend a system's RF coverage, especially in areas where available frequencies are limited, and in areas where physical barriers (e.g., mountains and buildings) can cause reduced signal coverage.

Trunked simulcast was developed by Motorola to meet the needs of users who were outgrowing their single-site radio systems. Simulcast offers the following advantages:

- **Improved Coverage** – One radio site may not provide the coverage necessary for the application in question. Simulcast expands the coverage area by expanding the number of radio sites without adding additional frequencies.
- **Efficient Use of Frequencies** – Adding sites typically requires more frequencies. In a simulcast system, the same frequencies are used at every site in the system. This makes very efficient use of the available spectrum.
- **Simplified Radio Operations** – Because the simulcast architecture operates like a single-site system, operations are simplified and radios are easy to use.

The ASTRO 25 simulcast infrastructure consists of a central simulcast prime site (a typical prime site is shown in Figure 0-8) and up to 32 distributed simulcast remote sites, each with up to 30 channels (a typical remote site is shown in Figure 0-9). The prime site acts as a control and digitized audio center for the simulcast subsystem. Audio is routed to the prime site from each simulcast remote site. To ensure that the best audio from the simulcast receivers is processed, a voting comparator selects the best signal.

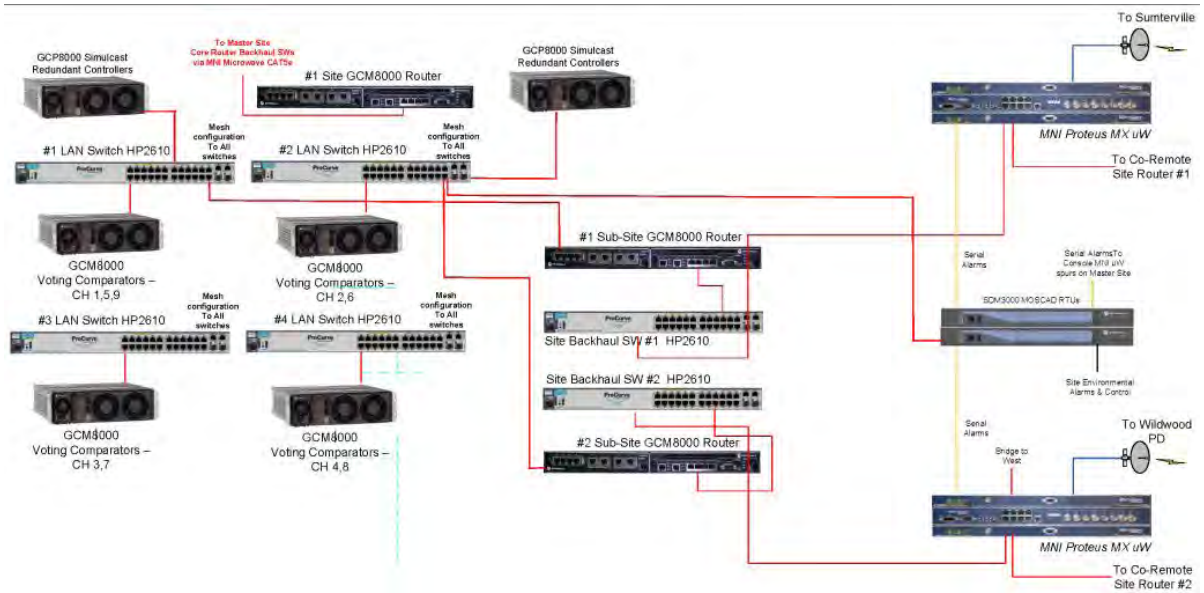

Figure 0-8: Basic Diagram of a Typical ASTRO 25 Simulcast Prime Site.

The prime site contains the prime site simulcast controller, simulcast comparators, and networking equipment to interface to the remote simulcast sites. The simulcast RF transmitters and receivers are located at the simulcast remote sites. These sites simultaneously transmit identical information from each site to the radios. The receivers at these sites receive the audio from the user radios, and pass the audio back to the prime site for voting. Audio and site control comes from the prime and master sites. Equipment at a simulcast remote site includes a simulcast base radios, fault management equipment, and networking equipment to interface to the prime site.

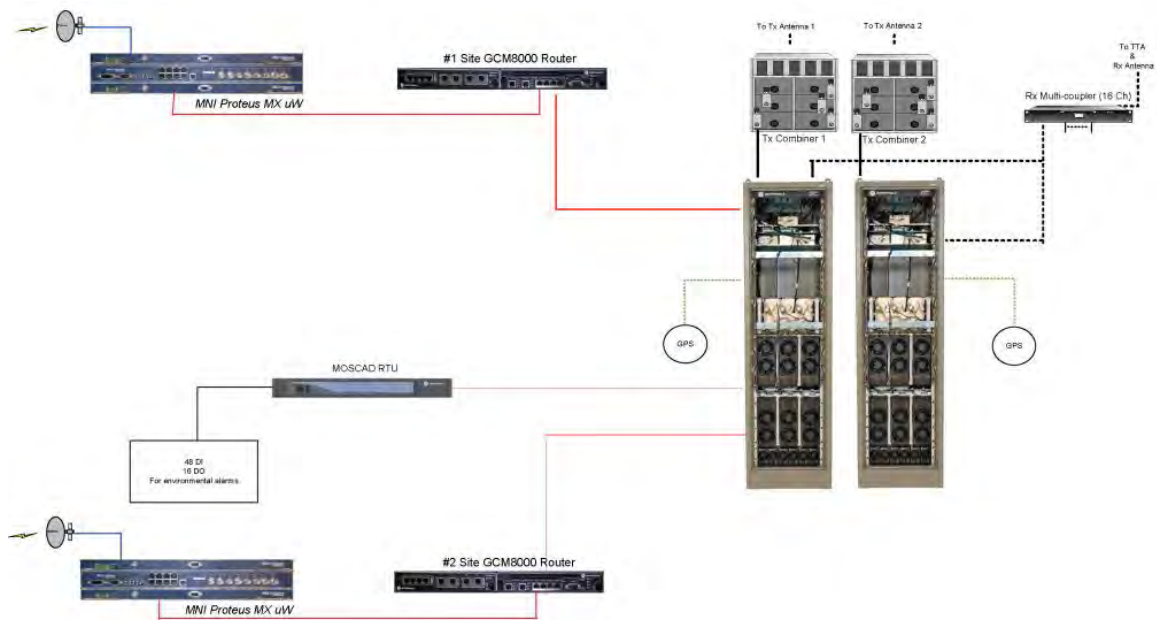

Figure 0-9: Basic Diagram of a Typical ASTRO 25 Simulcast Remote Site

Simulcast Prime Site

The ASTRO 25 Simulcast Prime Site consists of the following components, described in the Component Descriptions section of this System Description:

- GCP 8000 Site Controller
- GCM 8000 Comparator
- GGM 8000 Site Gateway
- TRAK 9100 Simulcast Site Reference
- Sub-site Access Router
- Prime Site Ethernet Switch
- Sub-site Ethernet Switch

Simulcast Remote Site

The ASTRO 25 Simulcast Remote Site consists of the following components, described in the Component Descriptions section of this System Description:

- GTR 8000 Expandable Site Subsystem (ESS)
- GTR 8000 Repeater/Base Radio
- GGM 800 Site Gateway
- TRAK 9100 Simulcast Site Reference
- Radio Frequency Distribution System (RFDS)
- Sub-Site Ethernet Switch

2.1.5.3 ASTRO 25 Component Descriptions

Each site type in an ASTRO 25 system contains various components. Components included in this system design are described in this section.

GTR 8000 Expandable Site Subsystem

The GTR 8000 Expandable Site Subsystem (ESS) enclosure can contain reconfigured GTR 8000 base stations, site LAN switches, and GCP 8000 controllers, along with an optional Radio Frequency Distribution System (RFDS), depending on your configuration needs.

Voice traffic is routed from each of the site base stations to the system for distribution all sites associated with the call. Benefits of the ESS include:

- Integrated design provides a smaller footprint at the site.
- Front/top access design and minimized cabling reduces install and service labor.
- Increased power supply redundancy through common power bus.

GCP 8000 Site Controller

The GCP 8000 Site Controller (GCP 8000) is the control interface between the transmitter/receiver subsystem and the Zone Controller. The GCP 8000 Site Controller comprises redundant site controller modules; one site controller module acts as the active module, and the second module acts as a standby. The redundancy minimizes the possibility of a single point of failure at the site.

The GCP 8000 provides the following functions:

- Manages the channels to maximize throughput and channel availability
- Administers registration and context activation requests

- Monitors base stations and RF distribution equipment and interacts with the MOSCAD site device manager to facilitate centralized alarm and control monitoring
- Provides redundant site control
- Enables redundant site link routing for patch redundancy

Additionally, the GCP 8000 provides the following functions at the simulcast site:

- Provides a time and frequency reference signal to the base stations, maximizing frequency stability and allowing for further site separation in a simulcast configuration
- Provides IP simulcast capability, enabling true end-to-end IP connectivity in a simulcast configuration.

GCM 8000 Comparator

The GCM 8000 Comparator ensures the broadcast of the best possible voice signal by combining the best parts of a single signal that has been received by multiple sites in a Multisite (simulcast) system.

The comparator features a digital voting methodology: Frame Diversity Reception. The comparator selects the data frame or signals with the lowest Bit Error Rate (BER) and forwards it. By using the best pieces of each input signal, the result is the best possible composite signal.

GTR 8000 Site Repeater/Base Radio

The GTR 8000 Base Radio consists of a transceiver module, power amplifier module, fan module, and power supply. The transceiver module includes the functionality for the exciter, receiver, and station control. The base radio software, configuration, and network management, as well as inbound/outbound traffic handling, are performed through this transceiver module. On-board serial and Ethernet ports are located on this module for local servicing via CSS. The power amplifier module amplifies the low-level modulated RF signal from the transceiver module and delivers the amplified signal on the path to the transmit antenna. The power supply module supports the transceiver and power amplifier modules, and can also provide auxiliary power to a connected site controller or Receive Multicoupler/Low Noise Amplifier (RMC/LNA).

Radio Frequency Distribution System

The Radio Frequency Distribution System (RFDS) provides interconnect between the base radios and antennas, allowing for a completely contained and more compact installation footprint. For the transmitters, this can include isolators, combiners, TX filters, diplexers, and power monitors.

For the receivers, this can include duplexers, site preselectors, and multicouplers. Various RFDS options exist for each of the GTR 8000 Base Radio, GTR 8000 Site Subsystem, and GTR 8000 Expandable Site Subsystem.

RF Site Gateway

The Site Gateway provides an interface that handles all of the IP Network Management traffic between the Core Site and the RF Site. The Site Gateway provides the following:

- **Media conversion** – the gateway converts Ethernet to the selected transport medium.
- **Traffic prioritization** – the gateway applies a prioritization marking to the packets leaving the site.
- **Fragmentation** – the gateway fragments large IP packets per industry standards.

Site LAN Switch

The site LAN Switch provides a LAN interface for site equipment and a LAN port for the site gateway. Through the switch, the service technicians gain access to service the site, and also access the system's Graphical User Interface (GUI).

TRAK 9100 Simulcast Site Reference

The TRAK 9100 Simulcast Site Reference is a GPS-based frequency and time reference. The TRAK frequency reference provides the simulcast system 1 PPS (Pulse per Second), 5 MPPS, and 1 PPS + 5 MPPS composite signals. These signals are used to synchronize the transmission of a simulcast system to improve overall performance and coverage.

This unit provides a high-level redundancy, including redundant GPS receivers, backup rubidium standard and redundant power supplies.

Sub-Site Access Routers

The sub-site access routers, located at the prime site, provide the IP network routing interfaces between the prime site and all of the sub-sites. In the single sub-site link configuration, two sub-site access routers are deployed in a cooperative WAN routing arrangement for T1/E1 subsystems. In the dual sub-site link configuration, two sub-site access routers each serve as the endpoint for one of the sub-site's WAN links. The sub-site access routers support T1, FT1, E1, FE1 and Ethernet sub-site links.

Note that the total number of access routers utilized at a trunking IP multi-site subsystem depends on the number of sub-sites. IP multi-site subsystems with 15 or less sub-sites require two access routers. Subsystems with more than 15 sub-sites, however, require two access router pairs (i.e., four access routers) where each access router pair can support up to 16 sub-sites.

Prime Site Ethernet Switches

Two paired Ethernet switches form the prime site LAN in an IP multi-site subsystem. They are paired for redundancy so if one of them fails, half of the hosts (site controllers, comparators) on the LAN are still connected to a working Ethernet switch. In addition to these switches, a third Ethernet switch is required for IP multi-site subsystems equipped with more than 15 sub-sites. For this configuration, all four access routers will have their LAN 2 ports connected to the third Ethernet LAN switch (crossover Ethernet cable is no longer utilized). It should be noted that although the third switch provides additional available ports, these ports should not be utilized for devices affecting critical services (e.g., comparators).

Customers may choose to improve resource availability further via the "Simulcast Prime Site High Availability" feature. This feature replaces the standard two LAN switch configuration (three switches for more than 15 sub-sites) at the simulcast prime site with four LAN switches set up in a mesh configuration. When the same site resources are spread across four LAN switches, the failure of a single switch will remove fewer resources hence improving the general availability of resources as well as improving the likelihood of preserving redundancy. Note, for subsystems with greater than 15 sub-sites, all four access routers will utilize the fourth switch for their LAN 2 connections.

In a single prime site link configuration, there is a single prime site router which is attached to one of the Ethernet switches. The entire subsystem is therefore, dependent on this Ethernet switch for its connection to the master site.

In a dual prime site link configuration, there are two prime site routers, each of which is attached to a different prime site LAN switch. This ensures that if either switch fails, there is still a path to a prime site router for connectivity to the master site.

Sub-Site Ethernet Switches – Non-Dual LAN Remote Sub-Site

There may be either one or two Ethernet switches at the sub-site to form the sub-site LAN. In a single sub-site link configuration, only one switch is used unless a second switch is needed to provide enough port capacity for all of the hosts at the sub-site. In a dual sub-site link configuration, two switches are used so that there is no single point of failure for the sub-site's entire IP network.

2.1.6 MCC 7500/7100 Dispatch CONSOLES

The MCC 7000 series standard features offer MetroSafe state-of-the-art communications, console management and configuration functionality, dispatch operation, and communications security.

The proposed system also offers MetroSafe the capability to maintain both audio and data recording of the calls made on the communications system.

2.1.6.1 Interoperability Features

ASTRO 25 is specifically designed around APCO P25 standards. All voice messages are digitized, all Land Mobile Radio (LMR) system features are compliant with P25 standards, and the system uses the P25-defined, 9600-bps control channel format for all control channel commands. As part of ongoing enhancements to this solution, Motorola has joined and actively participated in the P25 interoperability committee to ensure continuously improving interoperability with the radios of other P25 vendors. ASTRO 25 is also fully Common Air Interface (CAI) compliant.

**MUTUAL AID
INTEROPERABILITY
OFFERS FLEXIBILITY
AND FUTURE
EXPANSION.**

Motorola can use multiple customer-furnished interoperability radios to install, configure, and make operational the necessary hardware and software to provide two-way communications between the MCC 7000 series consoles and Mutual Aid channels.

As shown in Figure 0-10, interoperable communications can be provided through a dispatcher-initiated interface (patch) to the Mutual Aid radios. The Motorola Conventional

Channel Gateway (CCGW) forms the bridge between the MCC 7000 series dispatch console on the ASTRO 25 radio network and the Mutual Aid radios. This allows the dispatcher to patch together Mutual Aid radios and required subscribers on the ASTRO 25 system as situations dictate. Each GGM 8000-based CCGW can connect with up to four analog or V.24 ports, and 10 IP-based Mutual Aid channels. The high density GGM8000-based CCGW can connect with up to eight analog and eight V.24 ports, plus 10 IP-based Mutual Aid channels. Multiple CCGWs can be installed per site to support Mutual Aid radios for seamless communications with various agencies. CCGWs can be placed at any RF or console site allowing flexibility of connecting to the MCC 7000 series consoles. CCGW interfaces can be installed at any location as long as there is network connectivity back to the Zone Core. Additional CCGWs can easily be added anywhere on the LMR IP network as Mutual Aid requirements change.

As an incident occurs, local Mutual Aid agencies can initiate a radio conversation to an MCC 7000 series dispatch location via a programmed channel. By selecting an icon on the console monitor, the dispatcher can initiate a patch to an RF channel for first responders as necessary. Incident conversations will be seamless from the moment of the patch initiation, and can be recorded like any talk group conversation within the LMR network. The dispatcher will also be able to take part in and monitor conversations for the duration of the incident, as necessary.

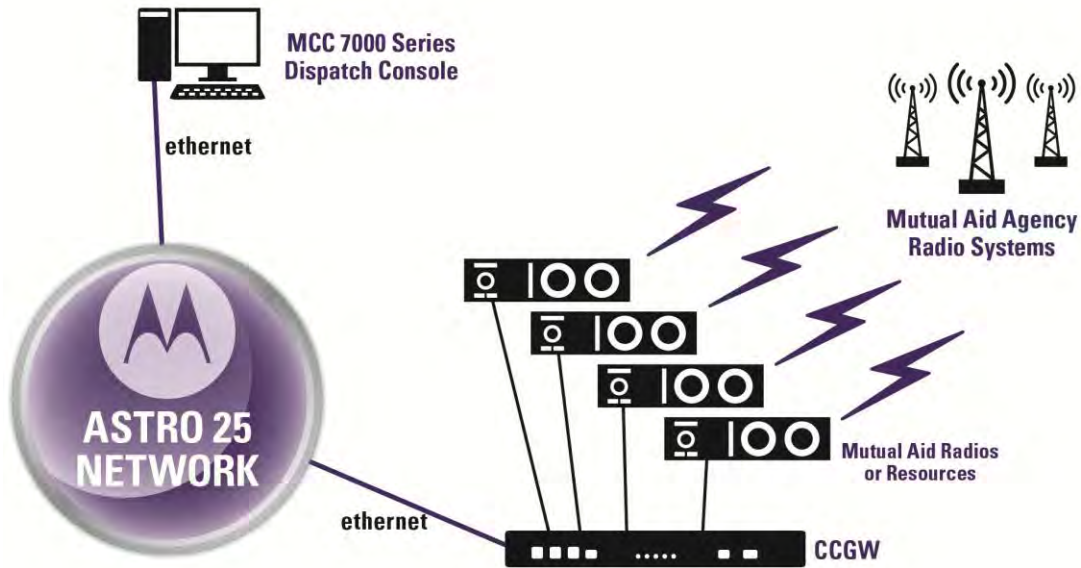

Figure 0-10: Mutual Aid Components

2.1.6.2 Integration with the ASTRO 25 Network

The MCC 7500 IP Dispatch Console will be seamlessly integrated into MetroSafe's ASTRO 25 system, without interface boxes, digital voice gateways or backroom electronics for an integrated mission critical network. This tight union between radio infrastructure and dispatch console equipment has several operational benefits to Louisville MetroSafe.

This modular IP approach substantially reduces the amount of space needed for backroom electronics. All dispatch activity is performed over IP. The physical space needed to accommodate the MCC 7500 console position is comparable to that required for a personal computer.

Both trunked talkgroups and conventional radio channels can be accessed and controlled from one MCC 7500 IP Dispatch Console over the same network. This reduces overall transport costs and the need for duplicate fixed network equipment. Table 0-10: Benefits of Seamless Integration of the MCC 7500 IP Console with MetroSafe's outlines the benefits of the MCC 7500's seamless integration to the ASTRO 25 network.

THE MCC 7000 SERIES CONSOLES' IMPROVED USE OF BANDWIDTH ENSURES THAT EMERGENCY CALLS WILL MAKE IT THROUGH TO THE DISPATCH OPERATOR, REGARDLESS OF SYSTEM TRAFFIC.



Table 0-10: Benefits of Seamless Integration of the MCC 7500 IP Console with MetroSafe's ASTRO 25 Network

Feature	Benefit to MetroSafe
Tight coordination between the IP network and IP console eliminates the potential for audio degradation.	Subscribers and console operators will be able to communicate without loss of information.
Emergency calls are prioritized for successful delivery regardless of network traffic.	Console operators will always be able to hear emergency calls from users in the field.
Inherent access to all system resources within the network provides dispatch priority to reach any user when needed.	Console operators will always be able to reach out to users in the field.
Rapid call set up times and quality of service, regardless of the size of the system.	The ability to scale the system to handle future capacity, while maintaining efficient dispatch operations.
True end-to-end encryption capable from the subscriber to the console operator position, enhancing operational security	Assurance that sensitive, private communications will remain secure, from the user in the field to the console dispatch operator.
Improved bandwidth efficiencies reduce transport costs.	Ongoing cost savings for MetroSafe.

2.1.6.2.1 Connection to ASTRO 25 System

Details on the connectivity between the MCC 7000 series dispatch console and the ASTRO 25 system are described below.

Redundant Site Links

To connect to MetroSafe's ASTRO 25 system redundant gateways are included. The site gateways provide an interface that handles all of the IP Network Management traffic between the MCC 7000 series dispatch console center and MetroSafe's ASTRO 25 system's core site. The site gateways fragment large IP packets according to industry standards, prioritize packets, and convert Ethernet data to the desired transport medium.

LAN Switch

The site LAN switches provides LAN interfaces for dispatch site equipment and a LAN port for the link to the core site. Through the switch, service technicians can access the system's configuration manager and service the equipment.

2.1.6.2.2 Agency Partitioning

With Agency Partitioning, MetroSafe's agencies will gain the interoperability benefits of being on the same system, be able to leverage cost savings in the maintenance of a shared system, and still maintain control of their own console configurations, channels, and encryption keys when applicable.

AGENCY PARTITIONING ALLOWS MULTIPLE AGENCIES TO OPERATE DISPATCH CONSOLES ON THE SAME SYSTEM.

The Agency Partitioning feature enables MetroSafe's system administrators to control who has access to functionality for the console network as a whole. It controls access for conventional RF channels, trunking talkgroups, auxiliary I/Os, pre-programmed pages, encryption keys, and configuration data. Agency Partitioning helps keep an agency's resources available for its users, while preventing unauthorized people from accessing or modifying the network configuration.

2.1.6.2.3 Conventional Base Station Interfaces

The MCC 7000 series consoles are capable of accessing and controlling MetroSafe's analog and digital conventional base stations through the use of conventional channel gateways (CCGW). This capability lowers MetroSafe's cost of ownership in two ways:

- It uses the same transport network, reducing the requirements for dedicated backhaul.
- It reduces the hardware requirements for interoperability, lowering fixed network equipment costs.

The dispatch console processes audio received from the station, and controls various features on the stations, such as frequency selection, private line selection, and repeater on/off.

Additionally, the Enhanced GGM 8000-based CCGWs allow for recovery of MDC1200 and digital signaling, such as unit ID, and emergency alarm, which is passed to the MCC 7500 dispatch operator position(s).

2.1.6.3 Console Operations

RELIABLE AUDIO IN REAL TIME

The MCC 7000 series dispatch console is designed to provide mission-critical audio between the dispatch console and users in the field. It is optimized for real-time audio, prioritizing emergency calls over other traffic, minimizing voice queuing, and transmitting calls in 450 milliseconds or less.

Using robust error mitigation to maintain call quality even when the system is heavily loaded, the MCC 7000 series console reduces communication errors that may force dispatch console operators to repeat their transmissions.

2.1.6.3.1 Dispatch Interface

The MCC 7000 series console's graphical user interface (GUI) optimizes user efficiency. It is designed to display the maximum number of resources a dispatch operator is able to easily view and control. Louisville MetroSafe can customize the MCC 7000 series GUI by agency or by individual user to meet their dynamic needs and requirements.

**EASY TO USE,
FLEXIBLE, AND
CUSTOMIZABLE
USER INTERFACE**

Elite Dispatch Graphical User Interface

The MCC 7000 series Elite Dispatch GUI is an enhanced version of Motorola's Gold Elite Dispatch GUI. For existing Gold Elite users, the GUI allows a smooth transition and minimal training for radio dispatch operators. For new users, the graphical icons and customization options make the MCC 7000 series console GUI easy to learn and operate.

An example of the MCC 7000 series GUI is shown in Figure 0-11.

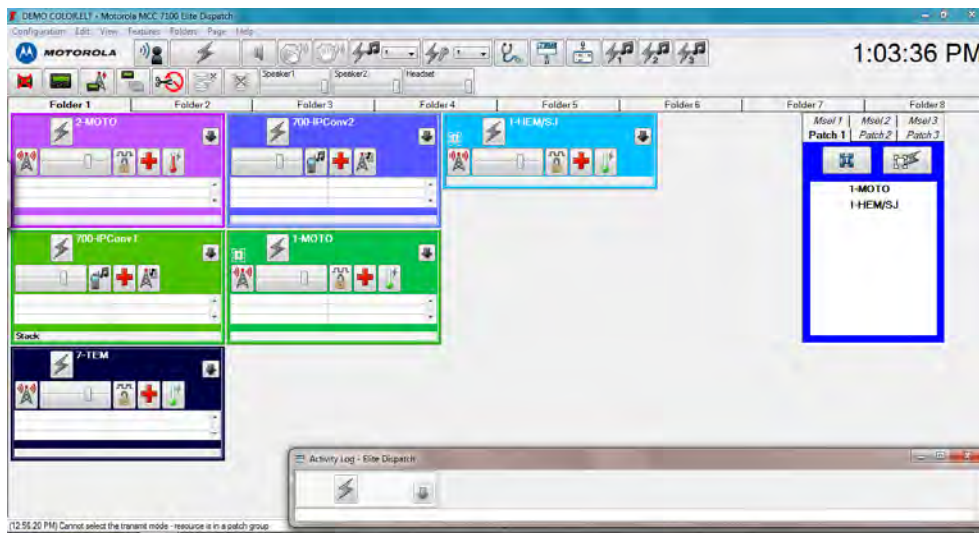

Figure 0-11: The MCC 7000 series GUI delivers critical real-time information is delivered to the console operator when and where they need it

Based on operator preference, the MCC 7000 series GUI can be customized to show details of trunked and conventional RF channels on a per-channel basis. Various controls can be highlighted, such as patch status, frequency select, coded/clear select, and individual volume control. Per-channel controls can be fully or partially shown, or hidden to save space on the screen. Busy dispatch operators can respond to a missed call by simply clicking on an entry in the Activity Log. The number of calls and call information displayed in the Activity Log is customizable to suit the needs of the user. The status of auxiliary inputs and outputs can be conveniently interpreted from the GUI with the use of familiar graphical icons, such as a door shown open or closed.

Auxiliary Inputs/Outputs

Dispatch Consoles support Global Auxiliary Inputs/Outputs (Aux I/Os) for remote status indications or remote control through dispatch consoles. Global Aux I/Os are typically implemented by hardware

that is independent of the dispatch console positions in a system and may be accessible to multiple dispatch consoles.

For dispatch consoles, Aux I/O functionality and support is provided by:

- Configuration of dispatch console Aux I/O parameters through network managers.
- Dispatch console display of status inputs/control outputs.

The Aux I/O Servers are used to provide the Aux I/O feature for the dispatch consoles. The consoles communicate to the Servers to perform the Aux I/O function.

2.1.6.3.2 Standard Radio Transmission and Reception

A typical MCC 7000 series console has two speakers, one for selected audio and the second for all remaining unselected audio. Additional speakers can be added to the console, allowing dispatch operators to configure a specific speaker for a set of designated audio sources. This simplifies multitasking between multiple audio sources, allowing flexibility in the way the audio is presented to the dispatch operator.

Receiving Calls from the Field and Other Dispatch Operators

Dispatch operators have great flexibility as to how to hear calls from field radio users and other dispatch operators. Each console dispatch operator can define his or her own audio reception profile. They can select a single audio source, whether conventional or talkgroup, to be heard on a selected speaker (“Single Select”). The dispatcher can also define groups of radio resources that can all be heard on a selected speaker (“Multi-Select”).

Initiating Calls to the Field and Other Dispatch Operators

The dispatch operator has several different ways of initiating a call. In most circumstances, a “General Transmit” is appropriate. With the general transmit, the dispatch operator selects a resource on the console and activates the transmission through a footswitch, headset transmit button, or a microphone transmit button.

If the dispatch operator needs to quickly transmit on a resource, they use the “Instant Transmit” function, which activates the resource regardless of whether it is selected. To prevent accidental activation of “Instant Transmit,” it can be limited through an “Instant Transmit Safety Switch,” which must be pressed prior to activation of “Instant Transmit.”

Making Calls to the Field and Other Dispatch Operators

The dispatch operator can transmit audio in different ways, depending on who they need to speak with and how important that communication is. Most basically, they can make calls to all users listening to a specific conventional radio resource or a specific trunking talkgroup. When multiple resources are required, the operator can select additional talkgroups and/or conventional channels as needed for the call using the multi-select feature.

The MCC 7500 console enables dispatch operators to make private calls to individual field radio users or dispatch operators. Once this private call is established, it can be patched in with another resource at the dispatch operator’s discretion.

Controlling Console Audio

The MCC 7000 series consoles offer the operator several different ways of controlling or muting the audio on their console. The operator can change the audio volume of any specific resource routed to a selected speaker and, if they desire, can mute and un-mute all non-selected resources on the console (“All Mute”) for 30 seconds.

The console enables the dispatcher to transmit on a resource while receiving audio from other resources. It also can prevent acoustic feedback when a co-located operator position transmits by muting the transmitting operator position's audio on a shared resource.

Controlling Network Audio

Dispatch operators can control the audio on the ASTRO 25 network. Using the console, the operator can enable or disable radio users in order to compartmentalize traffic, reduce interruptions, and maintain communications between dispatch and the field. When this function is enabled or disabled, all dispatch consoles with this resource assigned are updated with the current status of the feature. This feature can be controlled from any dispatch console.

Based on operator preference, the MCC 7000 series GUI can be customized to show details of RF resources on a per-channel basis. Various controls can be highlighted, such as patch status, frequency select, coded/clear select, and individual volume control. Per-channel controls can be fully or partially shown, or hidden to save space on the screen. Busy dispatch operators can respond to a missed call by simply clicking on an entry in the Activity Log. The number of calls and call information displayed in the Activity Log is customizable to suit the needs of the user. The status of auxiliary inputs and outputs can be conveniently interpreted from the GUI with the use of familiar graphical icons, such as a door shown open or closed.

2.1.6.3.3 Dispatch Audio Experience

Emergency Alarms

The MCC 7000 series dispatch console is capable of monitoring radio subscribers for user initiated emergency activations. On subscriber radios that are equipped and programmed to transmit an emergency alarm, the MCC 7000 series console detects that this emergency has occurred and displays the emergency on operator positions that are preprogrammed to receive the emergency notification.

Operator positions can be programmed to either receive the emergency or to completely ignore it. In the event of an emergency condition from a radio user, all programmed consoles will give both an audible and visual indication of the event. The dispatch operator can then silence the emergency leaving the visual indication on the screen indicating information on the initiating radio allowing the call to be handled and dispatched appropriately.

Once an emergency is received all programmed operator positions will give the audible and visual indication of the event. Any one of these operator positions has the ability to silence the emergency at only their position or for all operator positions on the system.

In the event of a system that all channels are busy at the RF site that receives the emergency, that event is automatically given a Priority Level 1. This is the highest priority possible, putting the emergency call at the top of any busy queue. The emergency call will be given the next available voice channel at that site bumping all non-emergency calls in the queue.

Desktop Speakers

Each dispatch console is capable of supporting up to eight audio speakers. In this design, four speakers are included per position. These speakers supply audio for select/unselect, as well as pre-determined audio sources to specific monitor speakers, each of which transmits unique audio—that is, an audio source cannot appear in multiple speakers at a single dispatch console. Monitor speakers – can tie specific talkgroups to a certain speaker, such as all fire resources to speaker 3.

Each speaker has individual volume controls, and contains an amplifier that provides a maximum of 2 Watts of power output. Speakers are self-contained units, and can be placed on a desktop, mounted in a rack/furniture, mounted on a wall, or mounted on a computer monitor.



Headset Jack

Each dispatch console is capable of supporting up to two headset jacks. A headset jack allows a dispatch console user to use a headset while operating the dispatch console. Each headset can either be connected to the console for supervisory applications, or to a desk telephone. The equipment design proposed includes two headset jack(s) per operator.

The headset jack contains two volume controls: one for adjusting the level of received radio audio and one for adjusting the level of received telephone audio.

The headset jack supports headsets which use either PJ7 (6-wire) or PJ327 (4-wire) longframe connectors (6-wire headsets have a PTT button while 4-wire headsets do not have a PTT button).

Footswitch

Each dispatch console is capable of a dual pedal footswitch. The footswitch can be configured to control general transmit and monitor functions.

Instant Recall Recorder Port (for Radio)

Short-term, console-specific audio recording is a mechanism used to record a portion of the inbound audio present on a specific dispatch console and make it readily available to the dispatch console user. This recorded audio is retained by the recording system for a short period (typically about 60 minutes) and is easily played back by the dispatch console user. This allows the dispatch console user to replay received audio that the user may have missed.

The instant recall recorder port (for radio) allows an instant recall recorder to be connected to a dispatch console. The port provides an output containing the receive radio audio on the selected channels. Transmit audio of any type (from either this dispatch console or a parallel dispatch console) as well as tones generated by the dispatch console (emergency tones, callback tones, busy tones) are not included in the audio output.

Dispatch console generated tones (e.g., emergency alarm tones, trunking busy tones, error tones, etc.) are not included in the audio appearing at the analog audio output. This is done so that they do not interfere with the dispatch console user's ability to understand the voice audio that was recorded.

Telephone/Headset Port

The telephone/headset port allows an external telephone set to be connected to the dispatch console. The dispatch console's headset can then be used to communicate on both the radio system and a telephone system (i.e. a 911 system).

When a telephone call occurs at a dispatch position, radio audio is directed from the headset to the appropriate console speaker. The headset microphone audio is routed to the telephone, allowing the dispatch console user to communicate hands-free on the telephone set. When the dispatch operator ends their call, the headset reverts back to full radio operation.

When the dispatch operator transmits on a radio resource during a telephone call, the headset microphone is re-routed to the radio system for the duration of the transmission. Once the transmission is completed, the headset microphone is routed back to the telephone. During the transmission, the dispatch operator continues to hear the telephone audio through the headset.

2.1.6.3.4 Console Telephony

Advanced Conventional

This option will provide the dispatch operator the ability to control ASTRO 25 conventional channels

and/or MDC 1200 channels.

2.1.6.3.5 Emergency Radio Transmission and Reception

As part of a mission-critical communications network, the MCC 7000 series console facilitates immediate prioritization and resolution of emergency communications between MetroSafe's dispatch and first responders in the field. This enables dispatch operators and first responders to focus on their mission, not their equipment—especially during critical situations.

When a field user or another dispatch operator initiates an emergency call, the console emits both visual and audible indications (“Emergency Alarm”). The operator can then “recognize” the emergency call, which ends the audible emergency indication and notifies all console operators that the emergency is being addressed (“Emergency Recognize”). The audible emergency indication may also be muted by a console operator without recognizing the emergency alarm (“Mute Tones at a Single Op”). When an emergency is over, the dispatch console user can end the Emergency Alarm. The emergency mode remains active on the initiating radio unit until it is ended (reset) by the radio user.

Receiving an Emergency Call

When a field user or another dispatch operator initiates an emergency call, the console emits both visual and audible indications (“Emergency Alarm”). The audible indication works to alert the dispatch operator that an emergency is underway; the visual indication directs the dispatch operator’s attention to the specific resource on which the emergency call is being made. The dispatch operator can immediately reserve a voice channel for the duration of the emergency.

The audible indication for an emergency is generated at the maximum level of the received audio, regardless of what volume the console has set that resource to. This is to ensure that the console operator does not miss the call. When the emergency call has been acknowledged, the volume for that resource is returned to its previous level.

Responding to an Emergency Call

When a console operator wishes to respond to an emergency call, they can bypass the standard console interface to auto-open a quick list, which contains specific controls for recognizing an emergency call, initiating an emergency call, and ending an emergency call (“Auto-Open of Quick List”). The operator can then “recognize” the emergency call, which ends the audible emergency indication and notifies all console operators that the emergency is being addressed (“Emergency Recognize”).

The audible emergency indication may also be muted by a console operator without recognizing the emergency alarm (“Mute Tones at a Single Op”). This would be used in a situation where one agency is monitoring a channel that belongs to another agency. If an emergency alarm comes in on the second agency's channel, the first agency could mute the tones at their dispatch consoles without having to wait for the second agency to recognize it.

Ending an Emergency Call

When an emergency is over, the dispatch console user can end the Emergency Alarm. The visual indication on the console GUI is removed, and the console informs the other operator positions that the emergency is over (“Emergency End/Knockdown”).

The emergency mode remains active on the initiating radio unit until it is ended (reset) by the radio user.

2.1.6.3.6 Radio Patch Control

MCC 7500 console users can patch communication between trunked and/or conventional radios that are normally unable to communicate with each other due to different features, programming, or even different frequency bands. A patch group is a group of linked resources that can both receive messages from a console and transmit to all other members of the patch group. The MCC 7500 supports a maximum of 16 active patch groups.

Setting up a Standard Patch

A dispatch operator can set up a standard patch between trunked resources and/or conventional resources. After the patch is created, the dispatch console transmits all audio on one resource to all other resources in the patch group.

Patched radio users see the ID or alias of the other patched radio(s), as opposed to that of the console, provided that the radio subscriber is capable of displaying IDs. This minimizes confusion and the need for the dispatch operator to intervene in the call. Patches are automatically re-established if interrupted so the MCC 7500 user can concentrate on continuing operations.

Pre-Defined Patches

Patches can also be pre-defined, and be automatically re-initiated each time a dispatch console computer is restarted (“Patch Auto-Start”).

Using Multi-Select

The Multi-Select feature allows a dispatch console to define groups of selected radio resources. When a Multi-Select group is opened, all of the resources in the group are simultaneously selected. Resources can be added or removed from a Multi-Select group while it is open or while it is closed.

The Multi-Select feature:

- Selects multiple resources simultaneously.
- Defines and stores groups of resources so that multiple resources can be conveniently selected and deselected.

2.1.6.3.7 Call Management and Control

Automatic Prioritization of Calls

Calls on the MCC 7000 series console are prioritized through a transmission hierarchy. Calls from primary supervisors take priority over those from secondary supervisors, which in turn take priority over non-supervisors. Instant Transmit or All-Points Bulletin (APB) transmissions, regardless of whether they are from a supervisor, will take priority over general or patch transmissions.

Multiple dispatch console operators can be designated as primary supervisors on the same system, which is useful when multiple agencies share one system, each with their own primary supervisor.

Console supervisors have the capability to disable and enable operator console functionality as necessary.

Manual Prioritization of Calls

“System Access Priority Select” allows a dispatch operator to prioritize trunked resources on the system as either “normal” or “tactical.” A dispatch operator can change the priority of a trunked resource to tactical in order to give the resource a better chance of gaining communication access on a busy system. Only emergency calls have a higher priority than tactical. When the System Access

Priority status of a resource is changed, it is updated at all dispatch consoles in the systems that are monitoring that trunked resource.

Standard Call Indications

The MCC 7000 series console indicates the availability of any given resource, whether or not it is being transmitted on at the moment. It will also give an inbound call indication that provides the console operator with a visual cue of audio activity on a radio resource. This functionality makes it easy for an operator to see at a glance what the status of a resource is at any moment.

Resource Identification

To identify a resource, the console reads its unit ID, a string of digits that uniquely represent that resource. The console makes it easy for operators to read unit IDs by replacing them with user-friendly 16-character aliases. These aliases, which are defined during the configuration of the console system, can replace the unit IDs of the following resources:

- Trunking Talkgroup Resource.
- Trunking Announcement Group Resource.
- Trunking Individual Call Resource.
- Conventional Channel Resource.
- Conventional Channel Frequency Selection Control.
- Conventional Channel PL Selection Control.
- Unit ID.
- Aux I/O Resource.

On large systems, unit IDs can be conserved by grouping all individual call resources on a specific trunking talkgroup together under a certain ID. This flexibility simplifies the daily work of MetroSafe's dispatch operators.

Call Alerting

When an operator needs to reach a radio user or dispatch operator and they are not near their radio or console, the dispatch operator can “page” the unattended radio or console through a series of beeps and an indication of the sender’s ID. When the radio user or dispatch operator becomes available, they will see the unit ID of the calling dispatch operator’s console or radio ID, and be able to return the call. Additionally, a Call Alert can be used to trigger an activity. For instance, a Call Alert may cause a vehicle’s horn to sound and its lights to flash.

The console operator can even send a call alert to a user who is involved in voice and data communications over the network.

2.1.6.4 Console System Security

The MCC 7000 series dispatch console enables end-to-end encryption from the operator position to the ASTRO 25 network, so that at no point will MetroSafe's communications be undermined by unencrypted transmissions. Each dispatch operator will be able to fully participate in secure communications while being confident that sensitive, vital information will not be heard by unauthorized individuals.

Secure Access to the Console

To use the dispatch console, an operator must enter a valid radio system user account name and password. The dispatch console validates that information with the radio system’s network manager and allows the user to access only the resources for which the user has access rights. This also applies to third-party applications that use the dispatch console's API.

Secure Communications at the Console

The console itself encrypts and decrypts radio voice messages. Thus, radio voice messages are encrypted end-to-end, from the field radio user to the dispatch console. The console operator can choose whether or not to encrypt their transmissions on a particular trunked resource. Console operators can interface with agencies that have different encryption configurations without any manual intervention or delay. The MCC 7500 Console can support up to 60 calls simultaneously, using up to four different algorithms and multiple encryption keys.

To help reduce potential errors when managing encrypted communications, the MCC 7500 interface provides alerts when the console mode does not match that of a received call, and when a patch or multi-select group is being set up between a mix of clear and secure channels. The set of alerts available on the console are in Table 0-11, below.

Table 0-11: Security Indications

Indication/Alert	Indication/Alert Description
Receive Cross-Mode Indication	Indicates when an inbound call's secure mode does not match the console's outbound mode, so that the console operator can respond in the correct mode.
Clear Audio Alert	Provides visual and audible indication that a trunked radio transmission or reception is unencrypted.
Multi-Select Cross-Mode Alert	Indicates that different trunked resources in a multi-select group have different secure modes, preventing console operators from transmitting audio in both secure and non-secure modes.
Patch Cross-Mode Alert	Indicates that different trunked resources in a patch group have different secure modes, preventing console operators from transmitting audio that is intended to be secure in an unencrypted state.
Key Fail Indication	Indicates that a console cannot decrypt or encrypt a call due to a problem with an encryption key.
Panic Key Zeroizing	Erases all encryption keys at a specific console or AIS at the push of a button. The button is recessed in a panel to reduce the chance of accidentally pressing it.
Keypad/Indexset Selection via GUI	Enables the dispatch operator to manually select the keypad/indexset the dispatch console uses.
Key Management via KVL	Enables the operator to use the KVL to manage all keys for a dispatch console or archiving interface server.
Key Management via Store and Forward	Enables the operator to use a KVL and KMF to manage all keys for a console or archiving interface server.

2.1.6.5 Console Configuration and Management

The MCC 7000 series console system is configured and managed by the same configuration manager, fault manager, and performance reporting applications as the radio system. The user can define exactly which resources are available and how they are presented to the dispatch console user. This provides MetroSafe with a single point for configuring and managing the entire ASTRO 25 system. Changes are automatically distributed throughout the system. This centralized approach saves valuable time and effort for system administrators and technicians, and reduces the errors that can occur when radio IDs and other data are entered at multiple locations.

In addition, call traffic and performance reports for each console can be generated from the system's network manager. This enables administrators to quickly and easily ensure optimal effectiveness and efficiency.

2.1.6.6 Interface with MetroSafe's Computer-Aided-Dispatch (CAD) System

The Motorola MCC 7000 series dispatch console interfaces with MetroSafe's CAD system through Application Programming Interfaces (APIs). These APIs are designed to support both the dispatch console user interface and the CAD application simultaneously, so that the dispatch/CAD operators for MetroSafe will be able to control all communications from the console at the same time.

Supported APIs

Three APIs (Table 0-12) are available for use by third parties who wish to integrate their application with the MCC 7000 series dispatch console. Each of these APIs performs a different function in the console/CAD interface, allowing for control of the console through the CAD system and information transfer between the console and the CAD system.

Table 0-12: APIs supported by the MCC 7000 Series Dispatch Console

API	Functionality
Console Dispatch Interface API	<ul style="list-style-type: none"> ▪ Used for the overall management and maintenance of the connections between a software application and the dispatch system. ▪ Authenticates the dispatch console user's login account and associates it with the security groups defined in the radio system's network manager. ▪ Allows a CAD application to interface to the MCC 7000 series console system. ▪ Delivers API messages either directly to the CAD application or enables retrieval of API messages upon request by the CAD application.
Resource Configuration API	<ul style="list-style-type: none"> ▪ Retrieves configuration information such as lists of radio resources, capabilities/features available on each radio resource, and lists of accessible auxiliary input/output signals. ▪ Retrieves aliasing information such as the end user radio unit IDs (e.g., Unit 4352 = "Division ABCD") and end user radio unit status (e.g., Status 7 = "En Route").
Console Features API	<ul style="list-style-type: none"> ▪ Monitors and controls subscriber and console activity on the radio system. ▪ Initiates voice and data radio communications with a subscriber unit; and controls access to external equipment.

Software Developer Kit for the APIs

To aid in the integration of the dispatch console system with the CAD system, Motorola can provide a Software Developer Kit (SDK) that contains all information necessary to be able to access and use the APIs described above.

The SDK's manuals document the supported Motorola MCC 7000 series dispatch APIs, including access to various dispatch features, configuration information, and aliasing information. The SDK also includes various files needed by software developers as they create applications that use the APIs. These files include source code header/include (.h) files, library (.LIB) files, and dynamic link libraries (DLLs).

The SDK can be quoted to Louisville MetroSafe as an option. All software development costs associated with CAD integration with the MCC 7000 series dispatch console through APIs are the responsibility of MetroSafe and its selected CAD vendor.

2.1.7 MCC 7500 Dispatch Console Component Description

An MCC 7500 Dispatch IP Console consists of the following elements:

- Operator position computer
- Voice Processing Module (VPM)
- Auxiliary Input/Outputs
- Logging equipment
- Network equipment
- Conventional Channel Interface equipment

This section discusses the various components that make up the proposed MCC 7500 Dispatch Console system, **Error! Reference source not found.** These components are connected together and to the rest of the ASTRO 25 system on an IP network via console site routers and switches. The MCC 7500 Dispatch Console functions as an integrated component of the total radio system, fully participating in system level features such as end-to-end encryption and agency partitioning.

Since the network is IP-based, the system's interfaces and components can be distributed physically throughout the network. Logging components can be centrally located at the zone core or distributed at console sites. CCGWs can be located at conventional-only RF sites, at trunking RF sites, the master site, or at console sites with conventional stations. Aux I/O Servers can be placed anywhere in the zone, closest to where they are needed.

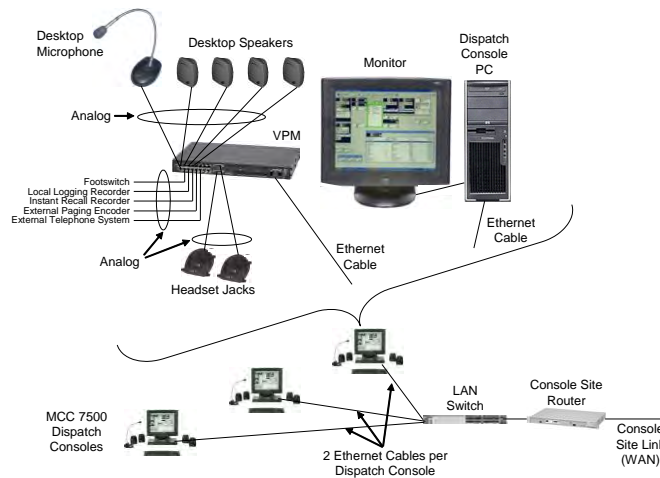

Figure 0-12: Motorola MCC7500 Dispatch Console Hardware Architecture



2.1.7.1 Operator Position Components

MCC7500 operator positions connect directly to the radio system's IP transport network without gateways or interface boxes. Audio processing, encryption, and switching intelligence for dispatch are performed within each software-based operator position, without additional centralized electronics.

The MCC7500 operator position consists of a computer, a Voice Processing Module (VPM), one select speaker, up to seven unselect speakers, a desktop gooseneck microphone and/or headset jack box with in-line PTT amplifier and headset, and footswitch.



MCC 7500 Operator Position Components

Voice Processing Module (VPM)

The VPM provides vocoding and audio processing services for the dispatch console. It connects to the console site LAN switch and communicates with the dispatch console PC via Ethernet. Each operator position includes a PC and a dedicated VPM. The VPM also provides connections for analog devices to be connected to the digital console.

The VPM has connectors for the following devices:

- One desktop microphone
- Two headset jacks
- Eight desktop speakers
- Logging recorder
- Radio instant recall recorder
- Telephone instant recall recorder
- External telephone set
- External paging encoder
- Footswitch
- Generic transmit audio input

Some of the connectors listed above can be used to provide audio inputs and outputs for connecting other types of dispatch consoles to the Motorola radio system in conjunction with the Motorola MCC 7500 Dispatch APIs.

The VPM also provides encryption and decryption services for the dispatch console. It is capable of supporting multiple, simultaneous encryption/decryption sessions using multiple algorithms and multiple secure keys.

Personal Computer (PC)

A PC running Microsoft Windows provides the user interface component of the dispatch position. The PC may be provided by the customer if desired as long as it meets the minimum hardware specifications..

2.1.7.2 Auxiliary Inputs and Outputs

An Auxiliary Input/Output server enables console operators to control and monitor external devices, such as doors and lights, from the console user interface. Multiple dispatch consoles anywhere in the network may monitor and control the same relay output and/or external inputs. Changes are indicated across all dispatch consoles simultaneously. Customizable graphic icons are also used to provide a visual indication of both the function and state of external inputs.

The contact closures and input buffers required to interface to these devices are housed in Remote Terminal Units (RTUs). These RTUs can be physically located close to where they are needed, at any console site or RF site. The dispatch consoles and RTUs communicate with each other across the radio system's IP transport network. Individual relay outputs can be configured so that they require a safety switch to be pressed before they respond to any commands from the dispatch console user.

Supported Aux I/O Configurations

The following Aux I/O configurations are supported.

Aux I/O Configuration	Description
Momentary Input	This is an input where the user interface always shows the true state of the input.
Latched Input	This is an input where the user interface does not necessarily show the true state of the input. When the input goes active, the user interface shows the state as active. The display will continue to show the state as active even if the input changes to the inactive state. A dispatch console user must manually reset the display to return it to the inactive state.
Momentary Output	This output relay is activated when the dispatch console user presses the button on the user interface and deactivated when the dispatch console user releases the button.
Latched Output	This output relay changes state only when the dispatch console user presses the button.
Interlocked Latched Output	This latched output relay is part of a group of latched output relays. Only one of the relays in the group may be active at a time. Interlocked relays work in a "break before make" fashion; that is, the previously active relay is deactivated before the new relay is activated.

2.1.8 Microwave Network

MetroSafe's existing OC-3 microwave radios and Fujitsu muxes will be replaced with the Aviat Eclipse series which offers native IP and TDM transport in the same platform. The upgrade will be implemented while keeping the current microwave ring intact by using a method known as "parallel pathing."

Parallel pathing allows a second frequency to operate across the existing microwave antenna system. This allows the new microwave ring to be installed, tested and commissioned without major service disruption to the existing ring.

2.1.8.1 Successful microwave frequency coordination is a critical path item

To implement parallel pathing, a second set of frequencies must be obtained for each of the 14 hops in the ring. There is no guarantee that 14 new frequencies that meet the parallel pathing constraints can be obtained. If a second frequency cannot be obtained for a given hop, an additional run of

waveguide and a cross-polarized antenna will need to be installed to accomplish the parallel pathing. The costs for these installations, if necessary, have not been included in the proposal.

The implementation of the simulcast cell is dependent on the completion of the IP-based microwave network. If the parallel pathing design cannot be implemented, the project cannot proceed

2.1.8.2 The 810 Barret Site will be eliminated from the ring

MetroSafe has indicated that the 768 Barret facility will no longer be used as a dispatch center. This leaves the 810 Barret microwave site that serves 768 Barret with no purpose. 810 Barret will be removed from the ring, saving the cost of required site improvements and microwave equipment. The Bardstown Rd site will be re-aligned to connect directly to the Meidinger Tower site. The microwave implementation schedule will determine when 768 Barret will no longer have connectivity to the current ASTRO 25 system.

2.1.8.3 Microwave System Layout

A larger version of this diagram is available in Section 0, System Layout.

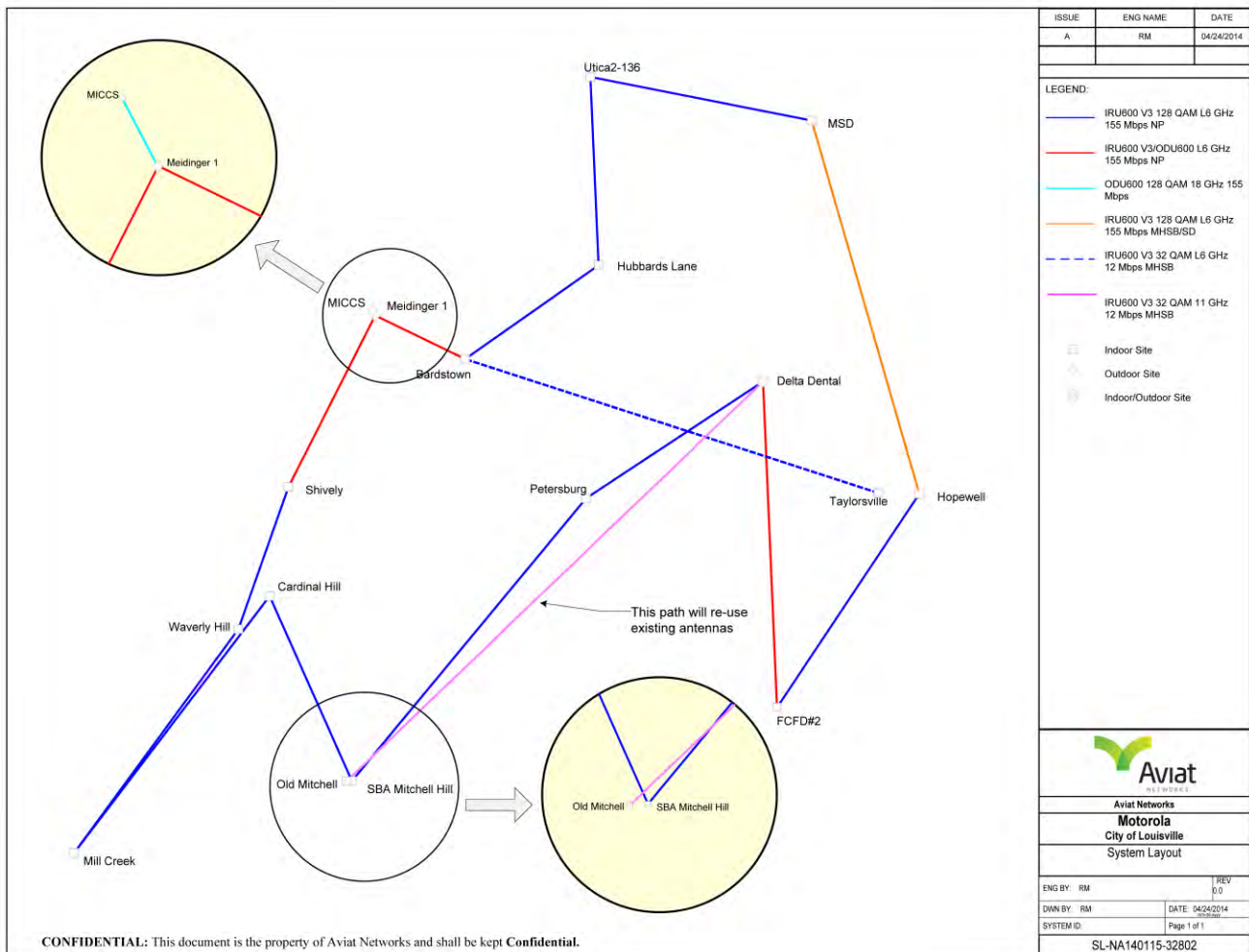

2.1.9 Aviat IRU600 Eclipse Platform

The IRU600 platform logically and seamlessly addresses transitioning from TDM, to Ethernet + TDM, and ultimately to a fully converged Ethernet network.

IRU600 is the leading wireless backhaul solution available, with an outstanding combination of compelling features:

- Optimized Wireless Nodes. IRU600 nodal solution supports indoor and multiple outdoor RF units with built-in traffic routing, add-and-drop, aggregation and selectable traffic interfaces, including DS1, DS3, OC3, Fast Ethernet, and Gigabit Ethernet
- Optimized redundancy options. 1+1, space diversity, frequency diversity and dual diversity protection options. Super-PDH ring protection, built-in T1 loop switch, 2+0 Layer 1 (L1) or Layer 2 (L2) link aggregation on GigE links, redundant interfaces on DS1, DS3, OC3, and Ethernet
- Scalable Capacity Architecture. Only pay for the capacity you need today. Migration can be delivered at minimal cost and service disruption
- Intelligent high speed data transport. Eclipse supports high speed Ethernet plus TDM traffic over a single radio channel, configurable bandwidth assignments with low latency, built-in L2 operation, service differentiation and QoS features
- Control and intelligence. Advanced network-wide management and diagnostics

IRU600 Platform Packet Capabilities

The IRU600 platform introduces a data Packet Plane with a 5 Gbit/s switching capacity, adaptive coding and modulation, extended link aggregation, and solutions for timing over Ethernet. The Data Packet Plane operates seamlessly with the existing TDM backplane (circuit plane).

- The Data Packet Plane routes Ethernet traffic directly between the GigE switch and packet radio modem(s) to deliver maximum payload efficiency with lowest latency
- The Packet Plane can also connect to the TDM backplane to support hybrid mixed-mode operation and to access wider aggregation and synchronization options

In combination, they optimize transport options for TDM + Ethernet and Ethernet-only traffic



Figure 0-13: High-Speed Planes Interconnect to Deliver Highest Nodal Capacity

In the Eclipse platform, operation is enabled on plug-in cards, selecting various data access cards (DACs) for DS1, DS3, Gigabit Ethernet, or SONET traffic. Radio access cards connect to the RF unit, allowing a variety of frequencies, capacities, protection and TX power levels.

Key Eclipse packet handling features include:

- Major increases in nodal throughput
- Advanced GigE switch with 1+1 redundancy options
- High-capacity links with QPSK to 256 QAM ACM and CCDP/XPIC options
- Advanced L1 and L2 link aggregation



- Timing over Ethernet solutions
- Easy upgrades with low incremental cost
- Maximum flexibility and scalability
- Comprehensive OAM capabilities in conjunction with its ProVision EMS

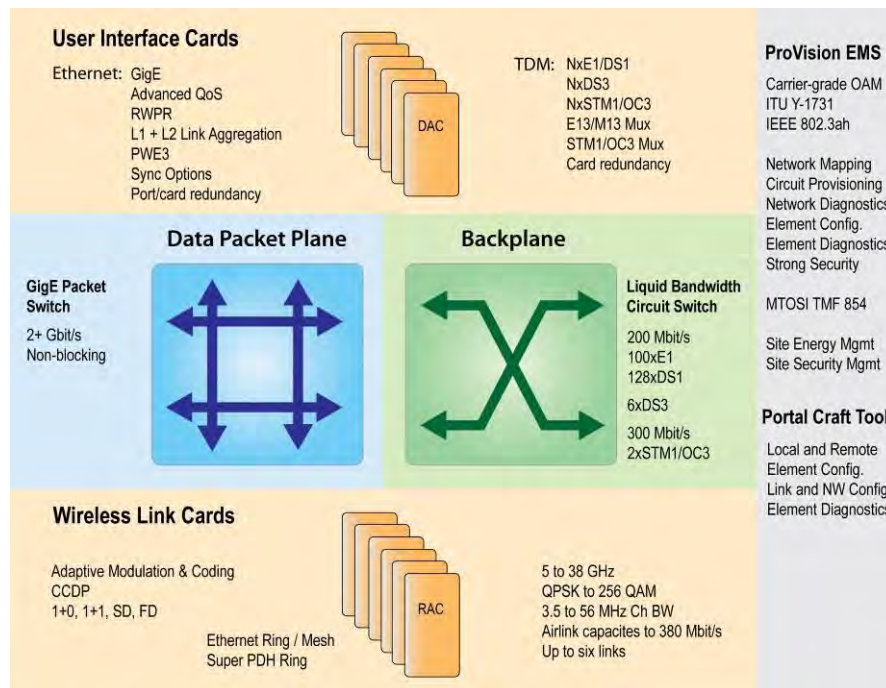

Figure 0-14: High-Level Eclipse Overview

Eclipse IRU600

The Aviat Eclipse IRU 600 is an all-indoor microwave radio. When deployed in conjunction with the Eclipse Intelligent Node Unit or IDU GE3 indoor unit, it supports TDM and native Ethernet/IP transport (no emulation) with following standard features:

- Transparent to all types of traffic, including all-IP, all-TDM, or hybrid
- High capacity transport up to 260 Mbit/s
- Standard and High Tx power options
- Front panel Tx Monitoring port for easy maintenance without traffic interruption
- Built-in expansion port for simplified expansion, connection to existing radio antenna systems and network cutover

The IRU 600 is built for the toughest conditions, engineered for high reliability and bulletproof redundancy. Reliability is combined with the Eclipse Strong Security suite, the industry’s highest level of microwave communications security. Security is integrated and embedded — not “added on” – providing enhanced security capabilities such as payload encryption, secure management and integrated RADIUS capability. The IRU 600 is built to last.

The Eclipse™ Packet Node Intelligent Node Unit (INUe)

The Eclipse™ Packet Node Intelligent Node Unit (INUe) is a highly modular and scalable indoor unit, when combined with the Eclipse Microwave Radio, delivers a combination of high capacity hybrid or all-packet transport, and comprehensive Mission Critical Microwave features. Figure 2-2 shows a typical INUe configuration.



Figure 0-15: INUe

The INU/INUe is equipped with a high speed backplane BUS which can be configured to support maximum TDM capacities of 127xDS1, 6xDS3, or 2xOC3. TDM and Ethernet traffic circuits can be mapped (digital cross connect) by software from a DAC to RAC or DAC to DAC via the backplane BUS thus eliminating the need for physical cross connections allowing the efficient use of available TDM tributary ports for traffic drops only.

In the Eclipse INUe, Adaptive Coding and Modulation (ACM), co-channel operation with XPIC, and optimized packet transmission combine to drive for maximum frequency efficiency and utilization.

Each INU/INUe requires a Node Controller Card (NCC) and a FAN plug-in card. All plug-in cards in an INU/INUe are hot swappable. Any maintenance activity on one plug in card will not affect radios or interface cards in-service co-located in the same chassis, provided that proper maintenance procedure is followed as per procedures provided in the Eclipse user manual.

2.1.9.1 ProVision Element Management System

The ProVision Element Management System delivers superior wireless networking intelligence by offering a unique feature set, based on industry standards, and designed to support the increasing demands of growing networks. By leveraging Aviat Networks' innovative microwave systems, ProVision maximizes network availability and throughput while significantly reducing OPEX.

Designed with the user in mind, ProVision is intuitive and adaptable for a wide range of activities that users can customize to match their network requirements. In addition, ProVision automates time consuming and error prone processes, such as the provisioning of end-to-end TDM and Ethernet services, bulk upgrading network firmware, and diagnosing network clock distribution problems.

With the ability to provide network management across Aviat Networks' complete product portfolio, including many key partner products, ProVision delivers an efficient, seamless end-to-end network management solution for TDM, Ethernet, and hybrid microwave networks.

A rack-mounted ProVision server will be installed at the MICCS site. The server will be used in normal day-to-day operations, to deploy devices, and change system or network configurations. The server database is backed-up to the standby server at regular time intervals, typically once per day.

The ProVision server will connect into the microwave network through the Eclipse INUe NMS port. The Eclipse NMS channel provides an OSPF routed network to all Eclipse INUe nodes and 3rd party connected devices such as the Eltek FlatPack2 chargers located at each site. The NMS channel is carried in the radio overhead and does not affect customer traffic capacity. All of the connected devices will be managed within a single GUI with physical and logical trees and customizable maps showing the status of each device.

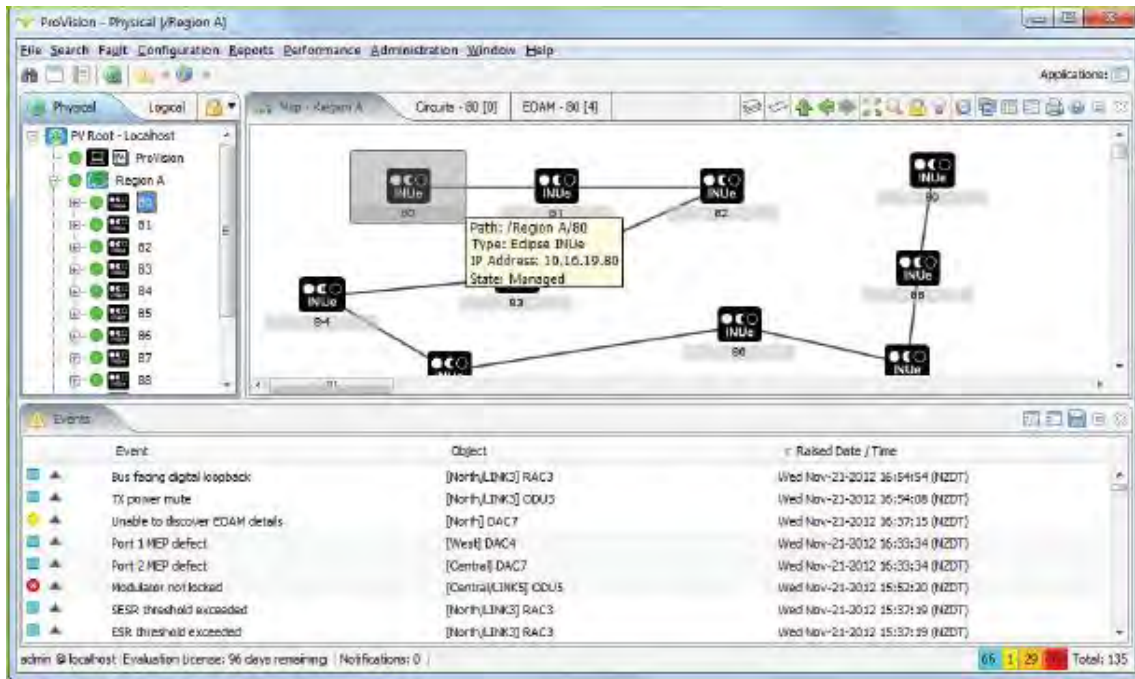

Figure 0-16: ProVision Physical Map Screen

ProVision EMS Features

ProVision provides a rich set of network/service assurance and provisioning features spanning both current and legacy Aviat platforms. Many partner products and third party platforms are also supported by the core subset of network assurance features.

Network Assurance Features:

- Highly scalable tree, map, and tabular views of network resources
- Automatic discovery of devices, configurations, RF links
- Event collection with browsers, notifications (email, SMS, etc) and graphical scoreboards views
- Device and RF (G.826, RX/TX, etc) performance collection with history and trend views, and alarm thresholding.
- Ethernet interface performance collection with history and trend views, and alarm thresholding.
- Ethernet bandwidth utilization network analysis
- Carrier Ethernet network analysis
- Automatic backup of device configurations with ability to restore
- RF, Ethernet and Clock sync network health analysis and reporting

Service Assurance Features: (Only on the Eclipse Platform)

Ethernet Services

- VLAN, Ethernet OAM, and ERPS automated discovery and visualization
- Automated end-to-end continuity testing
- Loopback and Link-Trace diagnostic testing

Provisioning Features:

- Provisioning of settings for multiple devices in bulk through predefined Configuration Profiles
- Software loading of devices in bulk
- License loading of devices in bulk

- TDM end-to-end circuit provisioning through graphical user interface
- Device integration

2.2 VHF PAGING

2.2.1 Simulcast System Component Descriptions

Each site type in the system contains various components. Components included in this system design are described in this section.

MLC 8000 Comparator/Gateway

The MLC 8000 enables circuit/IP site link combinations for voting and simulcast systems. The MLC 8000 can be configured as an analog comparator or an analog IP gateway and it supports the following functions:

- Interfaces directly with existing analog TRC consoles
- Interfaces directly with existing analog 4-wire base stations and receivers
- Supports Analog Simulcast over IP subsite links
- Supports Analog Simulcast over circuit subsite links
- Supports Analog Voting (non-simulcast) over any combination of circuit or IP subsite links
- Supports Analog Voting and Simulcast operation on the ASTRO® 25 K and M Core solutions with the MCC 7500
- Supports Conventional Analog Voting and Simulcast channels on ASTRO® 25 trunking solutions

The MLC 8000 supports voting and simulcast system configurations, and is fully compatible with G-Series base station / receivers and several of Motorola's other analog base station and receiver products.

GTR 8000 Base Station

The conventional GTR 8000 Base Radio provides the interface between mobile/subscriber radios that access the system on the APCO 25 FDMA Common Air Interface and the rest of the ASTRO® 25 Conventional system.

G-series site equipment products are very flexible and designed to support today's robust site designs. G-series site equipment products provide the flexibility to upgrade to future functionality through software downloads.

Network Equipment

The GGM 8000 Gateway and HP 2620 LAN switch have been included to provide the IP interface for the conventional simulcast system. The network equipment will carry all voice and network management traffic between the simulcast prime and remote sites.

2.2.2 System Components

Prime Site - MICCS

The prime site contains the prime site MLC 8000 comparator and networking equipment to interface to the remote simulcast sites. The prime site will also be the central point of the network and will connect to each RF site through microwave ring. The equipment for the prime site includes:

- One (1) MLC 8000 Comparator
- One (1) 7.5' Equipment Rack
- One (1) GGM 8000 Site Gateway
- One (1) HP 2620 Site LAN Switch

Remote Sites – Old Mitchell Hill, Delta Dental, FCFD #2, Waverly Hill, and Meidinger

The remote sites will contain the transmitters and receivers for the simulcast system. The existing QUANTAR will be replaced with a GTR 8000 station but will use the existing RFDS (Radio Frequency Distribution System), antennas and transmission lines. The equipment for each remote site includes:

- One (1) MLC 8000 Gateway
- One (1) GTR 8000 VHF Base Station
- One (1) 7.5' Equipment Rack (7' at Delta Dental)
- One (1) GGM 8000 Site Gateway
- One (1) HP 2620 Site LAN Switch
- One (1) AC-DC Power Inverter
- One (1) 48VDC Battery plant (Old Mitchell Hill site only)



2.2.3 System Diagram

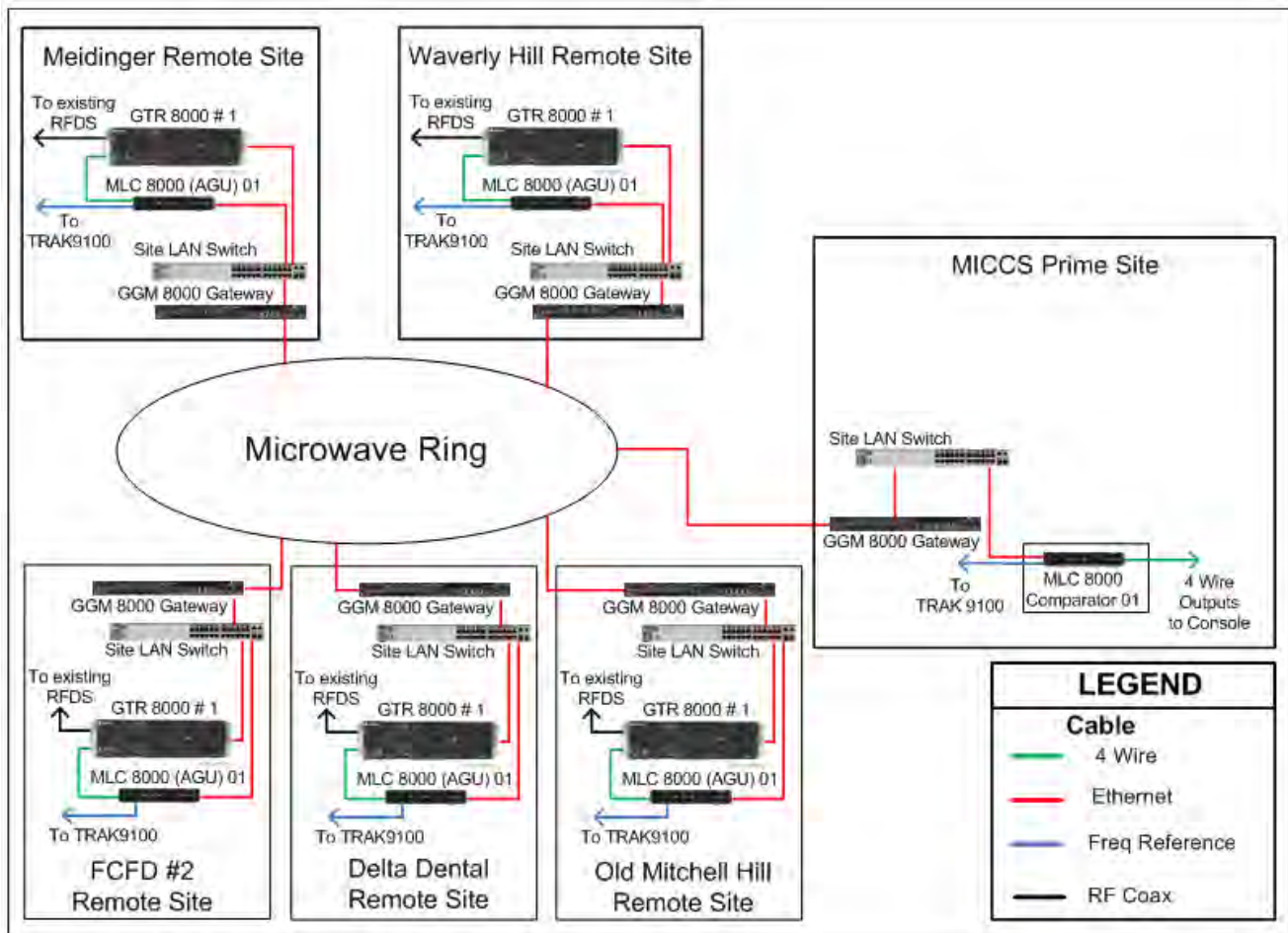

Figure 0-17: System Block Diagram

2.2.4 Assumptions

Motorola Solutions has made several assumptions in preparing this proposal. Motorola will need to verify all assumptions or seek alternate solutions in the case of invalid assumptions.

- Any existing antennas, transmission line, or RFDS equipment can be reused.
- The 4 wire output of the MLC 8000 comparators will connect to the dispatch center co-located at the MICCS Prime Site.
- Existing TRAK 9100s have the physical space to accommodate additional DSM cards.
- The existing sites have sufficient main and backup power at all the sites.
- All existing sites or equipment locations will have sufficient space for one rack of equipment.
- All existing sites or equipment locations will have adequate electrical power and be R56 compliant.
- Any site/location upgrades or modifications are the responsibility of the Customer.
- Each site will use the microwave network for site connectivity. The interface to the microwave network will be less than 100 meters to the proposed equipment rack and will have one RJ-45 Ethernet port available.



This proposal assumes only the VHF paging analog conventional simulcast system is purchased. If the mutual aid or FSA system is purchased simultaneously, it is possible a few network components can be removed in overlapping sites.

2.3 FIRE STATION ALERTING

Motorola Solutions is proposing an upgrade for the Louisville Fire Station Alerting (FSA) system. The proposed solution will migrate the analog conventional simulcast system from circuit connectivity to an IP network, and will upgrade the existing FSA equipment with the MACH Alert Fire Station Automation and Alerting system. The system topology will remain the same; it will be composed of one prime site and four remote sites.

Simulcast System Component Descriptions

Each site type in the system contains various components. Components included in this system design are described in this section.

MLC 8000 Comparator/Gateway

The MLC 8000 enables circuit/IP site link combinations for voting and simulcast systems. The MLC 8000 can be configured as an analog comparator or an analog IP gateway and it supports the following functions:

- Interfaces directly with existing analog TRC consoles
- Interfaces directly with existing analog 4-wire base stations and receivers
- Supports Analog Simulcast over IP subsite links
- Supports Analog Simulcast over circuit subsite links
- Supports Analog Voting (non-simulcast) over any combination of circuit or IP subsite links
- Supports Analog Voting and Simulcast operation on the ASTRO® 25 K and M Core solutions with the MCC 7500
- Supports Conventional Analog Voting and Simulcast channels on ASTRO® 25 trunking solutions

The MLC 8000 supports voting and simulcast system configurations, and is fully compatible with G-Series base station / receivers and several of Motorola's other analog base station and receiver products.

GTR 8000 Base Station

The conventional GTR 8000 Base Radio provides the interface between mobile/subscriber radios that access the system on the APCO 25 FDMA Common Air Interface and the rest of the ASTRO® 25 Conventional system.

G-series site equipment products are very flexible and designed to support today's robust site designs. G-series site equipment products provide the flexibility to upgrade to future functionality through software downloads.

Network Equipment

The GGM 8000 Gateway and HP 2620 LAN switch have been included to provide the IP interface for the conventional simulcast system. The network equipment will carry all voice and network management traffic between the simulcast prime and remote sites.



2.3.1 MACH Alert Component Descriptions

This “Total System Solution” consists of an Alerting Interface Controller (AIC), Station Controllers (SCs), and the FSA Server. The major components of the MACH Alert Fire Station Automation and Alerting (FSA) system are shown in the following figure. These components are described and their functionality presented in the ensuing sections. Available options to enhance the basic system are also provided.

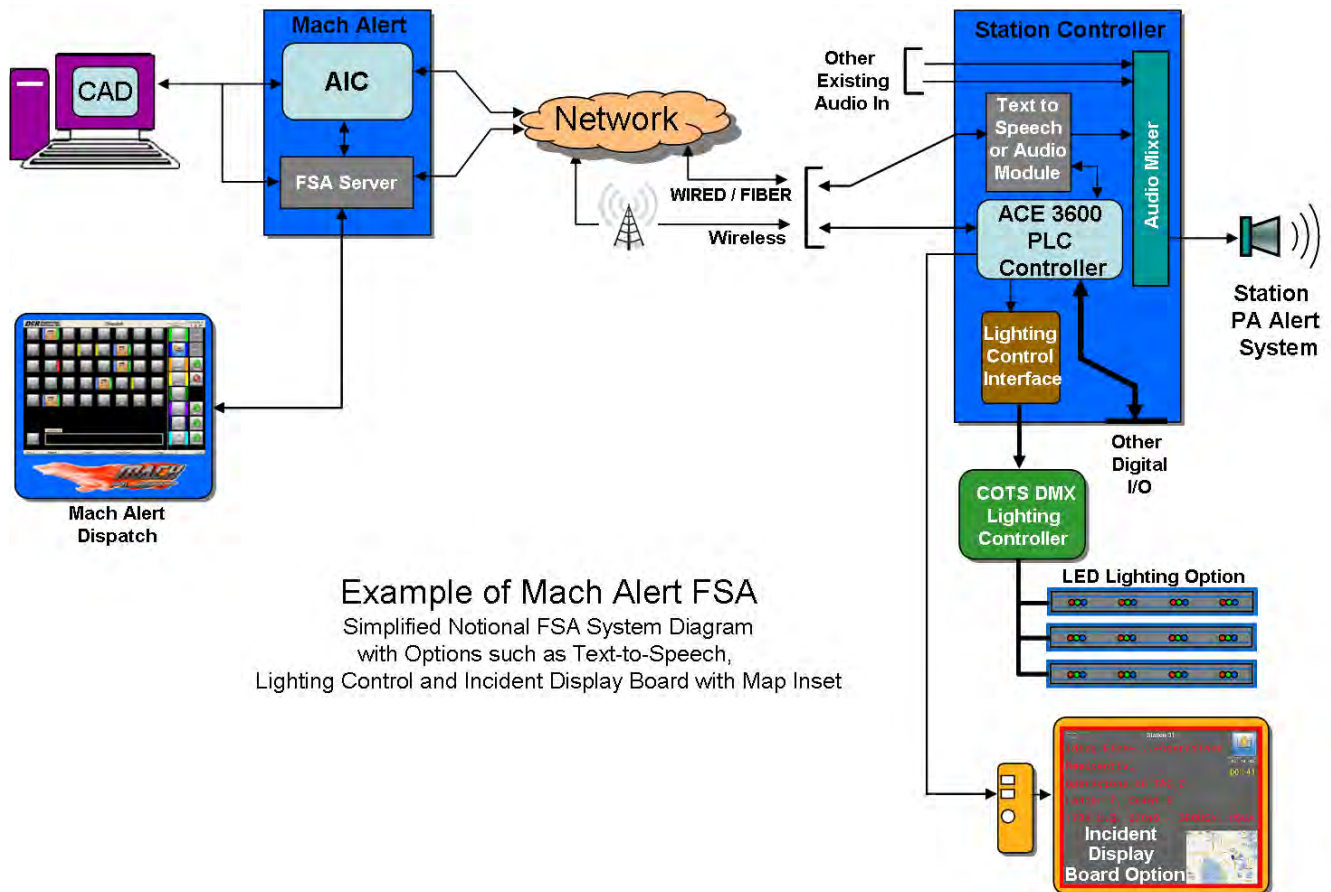

Example of Mach Alert FSA
Simplified Notional FSA System Diagram
with Options such as Text-to-Speech,
Lighting Control and Incident Display Board with Map Inset

Figure 0-18: Example of MACH Alert Fire Station Alerting

Typical Fire and Emergency Services Station

These primary areas are where the audio alerts and visual alert displays are placed for incident response.

- Apparatus Bay - where fire trucks, EMT ambulances, and other vehicles are stored.
- Day Room and kitchen area where firefighters spend much of the day when not dispatched.
- Turn Out area where firefighters have lockers and protective gear and outfits.
- Training room.
- Dormitory Area (“dorm”) is also referred to as “Bunk Rooms” or “Sleeping Quarters”.
- Other support areas.



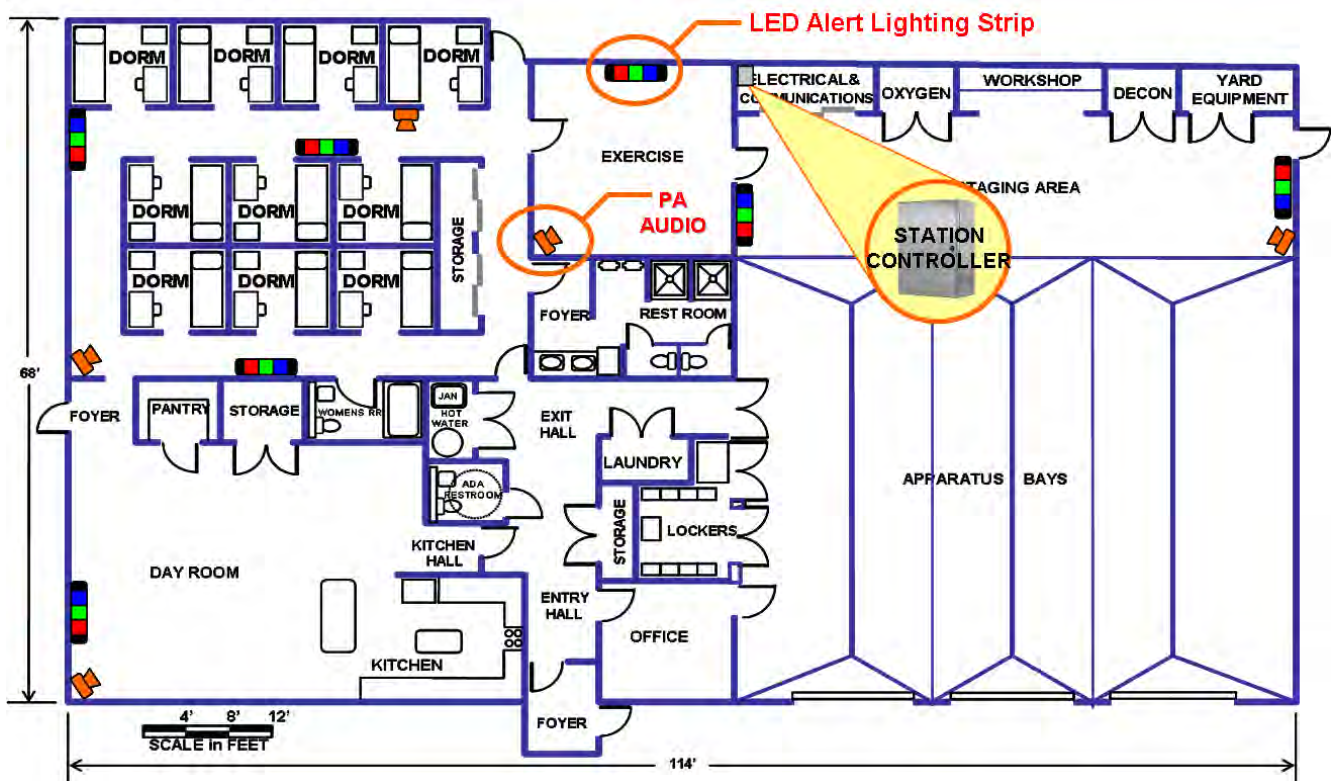

Figure 0-19: Typical Fire and Emergency Services Station

Alerting Interface Controller (AIC)

The Alerting Interface Controller (AIC) is a Motorola ACE3600 high-performance controller located at the Emergency Communications Center (dispatch).

The AIC interfaces the Computer Aided Dispatch (CAD) system and the FSA Server to the fire stations. The AIC can be configured to direct the flow of alerting data over redundant communication links, manage automated CAD station alerting, and receive Acknowledgments (“ACK”) from both the fire station controllers and the CAD system. The AIC interprets the CAD messages and relays alert signals and messages to the CAD-selected stations. The AIC also updates CAD with alerting information and status of the Fire Stations.

The AIC translates ASCII-based messages sent to and from CAD utilizing an RS232C serial interface based on the Motorola Fire Dispatch Protocol (MFD-P) V7.34.

The primary path for the data to be transmitted to the Fire Stations is through the Primary AIC connected to the FSA Server via MODBUS Ethernet. This interface may be used as the primary interface available to CAD; however, the FSA Server can be used as a backup dispatch interface. Regardless of the interface, the alerting data must be transmitted to the fire stations from the dispatch center. This is accomplished through the AIC.

The AIC will support up to two redundant data links. These links may be a combination of RF data and/or network Internet Protocol (IP). Each link has a status check indicating connectivity, and each site is messaged to confirm receipt of the alert message routed to it. These statuses are logged and alarmed as necessary on the FSA Server.

Station Controller

The Station Controller (SC) is a Motorola ACE3600 high-performance controller installed in a NEMA-1 wall-mount industrial control panel. It is UL 508A Listed. The SC is located at each fire station. The SC processes information to and from the AIC, generates alert tones, and processes various inputs and outputs utilizing the ACE 3600 I/O modules.

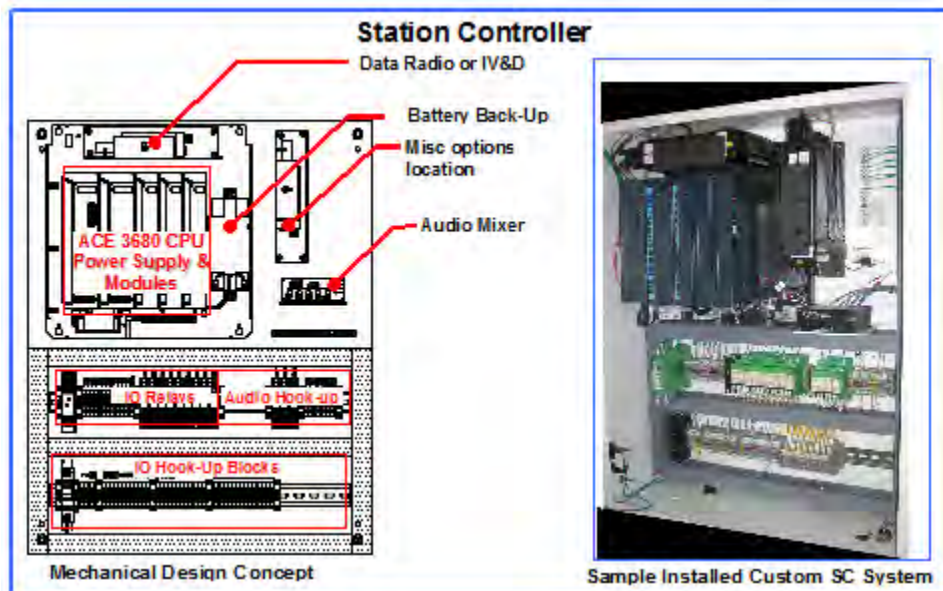

Figure 0-20: Station Controller

Some of the features for the station controller include:

- Station Audio Alerting - The station alerting hardware and software automatically controls the alerting process. When stations are alerted, unique alert tones are played over the station's PA system. To prevent additional stress, these tones will be ramped ("heart saver"); that is, they start at low volumes and escalate in volume to a desired level for a specific period of time. The tones can also be unique based on apparatus, company, and/or personnel. They can include a combination of tone and recorded voice (.wav, .mp3, .wma files). Custom, user-supplied tones are a standard feature of the system design. Toned alerting meets NFPA 1221 recommendations. There are two primary options available in MACH Alert for providing audio to the station.
- A DCR-produced Active Audio Module which supplies ramped alert tones and a brief pre-recorded voice alert designating for the type of alert, followed by opening the station PA system for the dispatcher or local microphone (or other input) to verbally alert personnel.

An optional Text-to-Speech function can translate a type-written alert message (CAD or MACH Alert-generated via the dispatcher) into simulated human-voice speech and transmit it over the IP network to the Station Controller as a compressed audio file for playback after completion of the locally stored alert tone.

LED Alert Lighting (Optional) - The optional use of LED lighting strips for the FSA installation are for visual alerting in addition to the audio alert (PA) system. The RGB lighting strip is compatible with commercially available controller. LED lighting strips which are activated and controlled in various colors and sequences to alert station personnel of conditions and warnings.

The optional LED lighting is connected to the Station Controller. The LED lighting can be configured for ramp time, maximum intensity and colors.



Bunkroom LED lighting is ramped. Each bunkroom can have a LED light strip that will activate based on the type of alert. For example, if the bunkroom is reserved for engine, the LED strip can be set to ramp to a red display. If the bunkroom is reserved for rescue, the LED strip can be set to ramp to a blue display. These high-intensity, RGB color LED strips can also be used in the common areas, bays, weight rooms, outside, offices, etc. When used in the hallways, they provide adjustable soft white egress lighting.

Existing zoned lighting can also be supported as an option. Station lighting, in certain areas, can be relayed so the Station Controller can turn the lights on or off based on the apparatus called.

- Station Zoning (Audio and Light Zones) - The MACH Alert FSA system supports the partitioning of field stations into specific zones, each receiving specific types of alerts. The FSA system can accommodate zone partitioning based on the individual needs of each fire station. It supports zoned alerting with ramped custom tones, ramped LED bunkroom lighting, apparatus bay and common area alert lighting, egress lighting, and automated outdoor speaker control (day/night modes). Also, as an option, the FSA system can support control of station lights, incident display boards (LCD monitors), count-down timers, plus other custom features designed for a fire department's specific needs.
- Incident Display Boards (IDB) Optional - IDBs can be provided for each fire station as a system option. High Definition (HD) LCD or plasma monitors can be provided and configured to display incoming alert incident information based on input from the CAD system (for example, units responding, address/location, incident type, cross streets, etc.) When alerted, the displays present a screen border color coded to indicate the call type. A "count-down" and "count-up" timer is displayed indicating the amount of turnout time left and the amount of time past the required departure. The count-down timer is yellow. When it indicates 00, it turns red for the count-up time.
 - Opening bay doors
 - Manual ACK to dispatch that the station was alerted
 - Manual ACK to dispatch that the first responder has exited the station
 - Automating exhaust systems
 - "Safe Zone" door bells can be heard over the PA system
 - Appliance shut-off (automatic upon alert or button push)
 - Bunkroom zoning
 - Monitoring station fire and intrusion alarms
 - Control of traffic signals
 - Monitoring generators (on/off, failures)
 - Status of appliances (on or off)
 - Status of fire station alerting equipment

The diagram below shows a typical Station Controller-based system with options implemented for alert lighting and audio as well as zone switches.

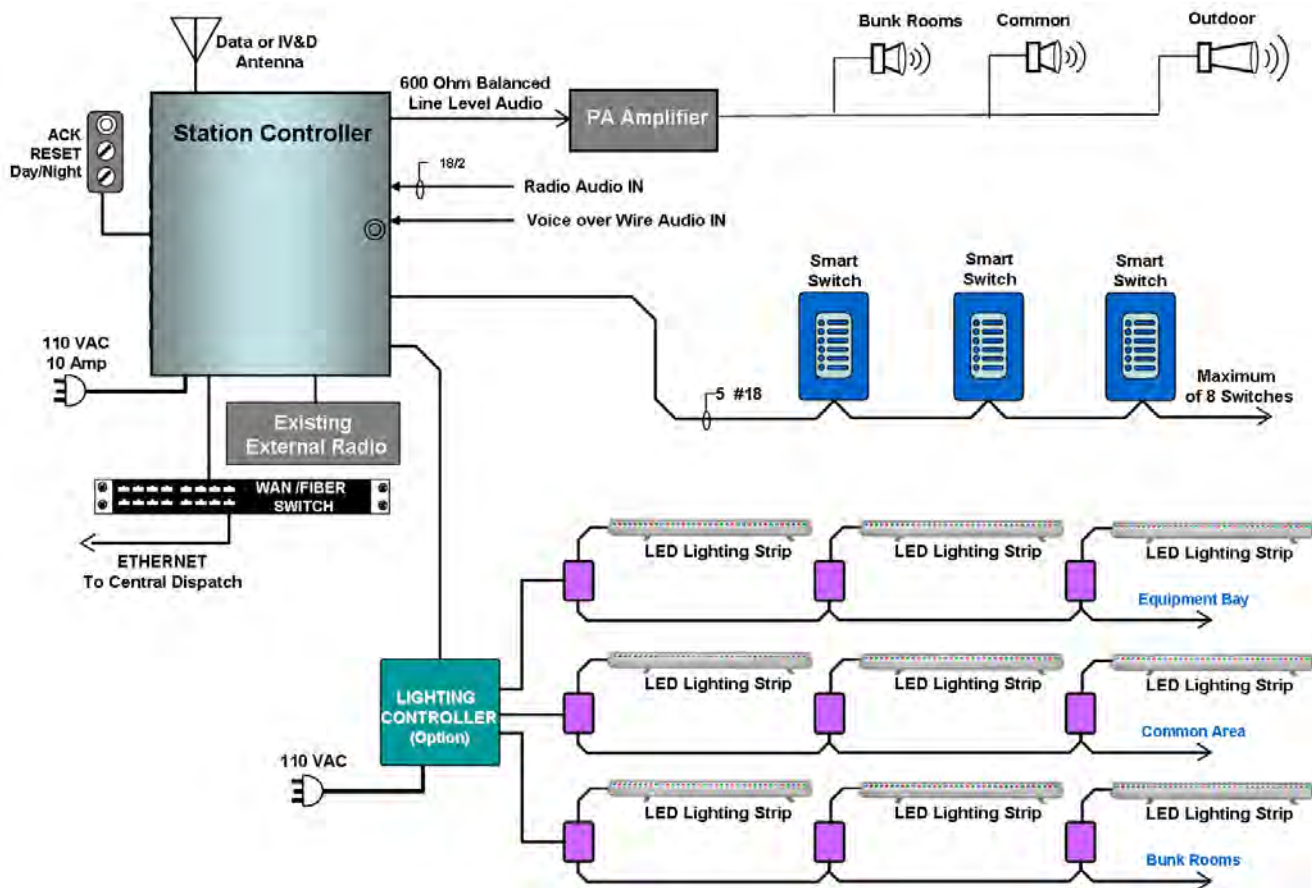

Figure 0-21: Typical Station Controller-based System

MACH Alert Dispatch

The Dispatch Center Operation consists of a dedicated FSA Server, FSA system software, dispatch position alerting browser client software, FSA system GUI screens, and IP text-to-speech (optional). The dispatch operation is located at the Emergency Communications Center (dispatch).

The FSA server is mounted in the equipment rack with the AIC. The FSA server has interfaces with the Computer Aided Dispatch (CAD) system and the AIC. The server manages dispatch operator manual station alerting, automated CAD optional AFTOP text-to-speech incident announcements, remote system access, and system alarm and event logging.

One of the primary functions of the Dispatch Center Operation is to provide a backup method of alerting the fire stations if the CAD system is unavailable. The MACH Alert FSA system includes dedicated Fire/EMS alerting GUI dispatch software.



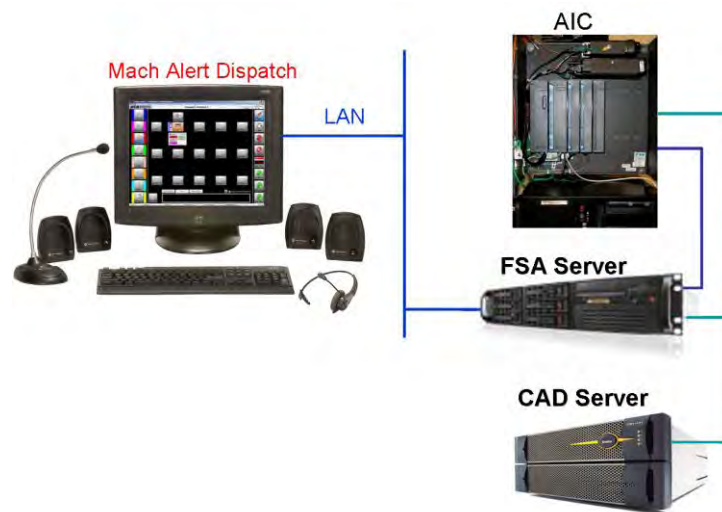

Figure 0-22: MACH Alert Dispatch

Alerting and Event Screens

The Station Alerting Screen displays easily identifiable icons at each of the dispatch positions. Also included are the Event Log Screen (includes real-time system alarms and events and a historical database), multiple system Configuration Screens, Communications Status Screen (includes real-time status of the radio and IP communications links, main power status, and SC backup battery status), Outdoor Speaker Control (Night-Mode) Screen, and the Report Generation Screen.

FSA Browser Viewing

The FSA system software is installed in the server and the FSA graphics can be viewed on the existing radio consoles, CAD workstations, or any PC with network access to the FSA Server and an Internet Explorer Browser. This integrated approach will allow each dispatch operator position to have control over the fire alerting process without CAD input. Additional workstations, monitors, and keyboards are not needed at the dispatch operator positions that would take up valuable desktop space at the dispatch positions. No GUI software is loaded on the PCs accessing the FSA Server. The browser will call and load an ActiveX client on the PC. Nothing needs to be pre-loaded

2.3.2 System Components

Prime Site - MICCS

The prime site contains the prime site MLC 8000 comparator and networking equipment to interface to the remote simulcast sites. The prime site will also be the central point of the network and will connect to each RF site through microwave ring. The equipment for the prime site includes:

- One (1) MLC 8000 Comparator
- One (1) 7.5' Equipment Rack
- One (1) GGM 8000 Site Gateway
- One (1) HP 2620 Site LAN Switch

Remote Site – MICCS (Co-located with Prime), Bardstown, Delta Dental, and Shively

The remote sites will contain the transmitters and receivers for the simulcast system. The existing QUANTAR will be replaced with a GTR 8000 station but will use the existing RFDS (Radio Frequency Distribution System), antennas and transmission lines. The equipment for each remote site includes:

- One (1) MLC 8000 Gateway
- One (1) GTR 8000 800MHz Base Station
- One (1) 7.5' Equipment Rack (7' at Delta Dental)
- One (1) GGM 8000 Site Gateway
- One (1) HP 2620 Site LAN Switch
- One (1) AC-DC Power Inverter

MACH Alert

The equipment for the MACH Alert Solution includes:

- Two (2) AIC – Alerting Interface Controllers (Redundant AICs)
- Twenty Eight (28) Station Controllers (One per Station)

Note: Spares have not been included in this proposal.

2.3.3 System Diagrams

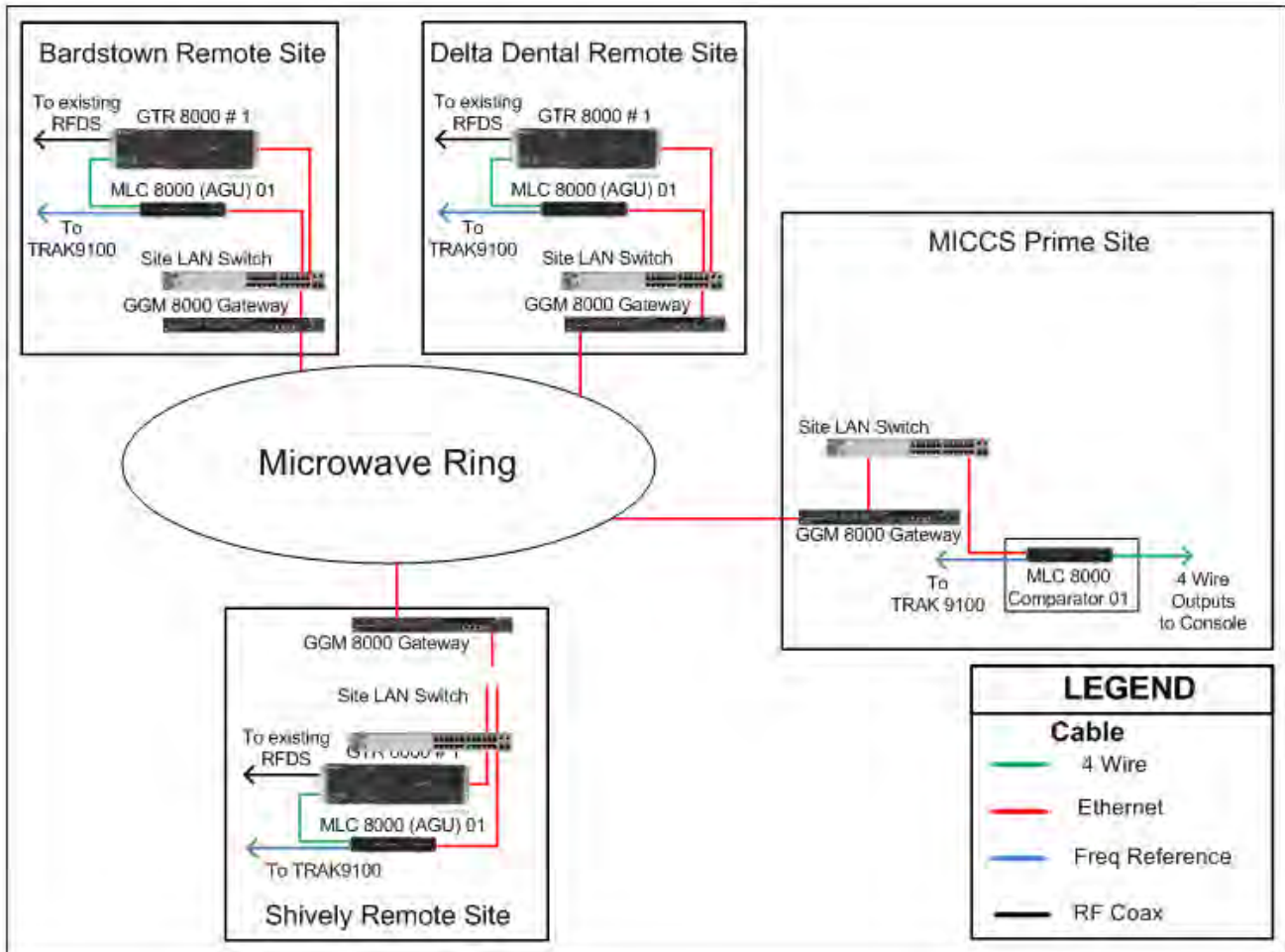

Figure 0-23: Radio System Block Diagram



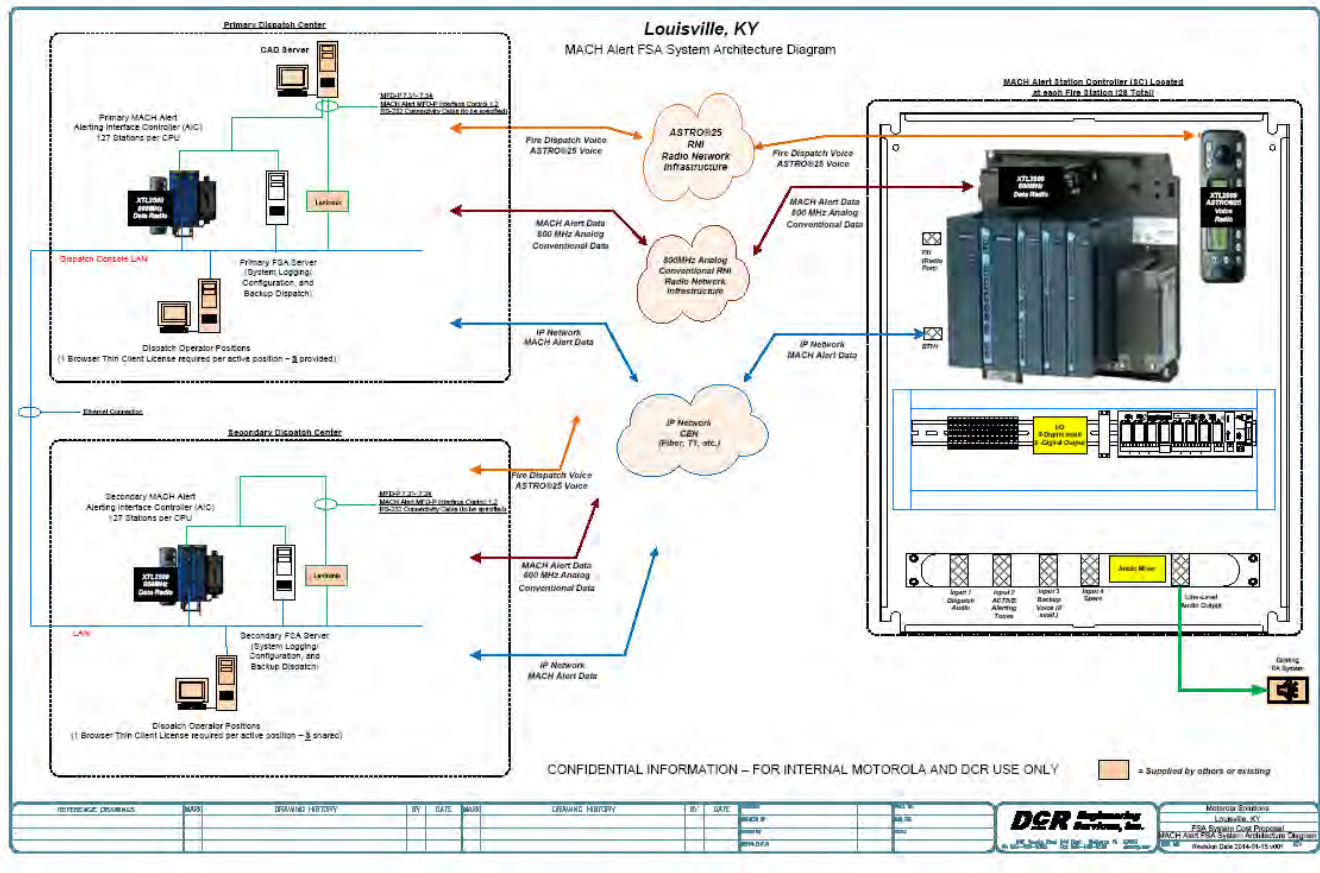

Figure 0-24: MACH Alert Block Diagram

2.3.4 Assumptions

Motorola Solutions has made several assumptions in preparing this proposal. Motorola will need to verify all assumptions or seek alternate solutions in the case of invalid assumptions.

- The existing sites have sufficient main and backup power at all the sites.
- All existing sites or equipment locations will have sufficient space for one rack of equipment.
- All existing sites or equipment locations will have adequate electrical power and be R56 compliant.
- Any site/location upgrades or modifications are the responsibility of the Customer.
- Each site will use the microwave network for site connectivity. The interface to the microwave network will be less than 100 meters to the proposed equipment rack and will interface have one RJ-45 Ethernet port available.
- This proposal assumes only the FSA analog conventional simulcast system is purchased. If the mutual aid or VHF paging system is purchased simultaneously, it is possible a few network components can be removed in overlapping sites.
- All existing ACE3600 RTUs will continue to be reused with the new MACH Alert solution

2.4 WAVE WORKGROUP COMMUNICATIONS

Motorola Solutions is proposing WAVE Workgroup Communications as an interoperability solution for Louisville.

WAVE enables highly scalable, feature rich, enterprise grade push-to-talk (PTT) on broadband networks and devices so that critical, time- sensitive information flows quickly and securely between mobile workers, teams and citizens.

We understand that personnel that use a radio system for operational purposes do not need to carry a ruggedized radio handset all of the time. Perhaps you're the Chief of Police and you want to access ASTRO25 digital communications from your iPhone when at a conference. Maybe you're a government agent working undercover. Your Android smartphone and earbuds would be ideal to connect to other tactical units while keeping you inconspicuous

2.4.1 WAVE Overview

Extending Project25 Radio To Broadband

WAVE interfaces directly to the ASTRO 25 trunking system so that users with Smartphones (Android or Apple), tablets or PC's can monitor and talk on the Project 25 system when they are on a 3G/4G network or WiFi.

Deploy Broadband PTT

Secure, 'over-the-top' PTT connecting smart devices over 3/4G LTE and WiFi networks delivers greater choice and flexibility when choosing a non-radio, carrier-independent communications solution.

2.4.1.1 WAVE Applications

WAVE Mobile Communicator

With a WAVE Mobile Communicator installed on a smartphone, tablet or custom handheld, any user can access PTT communications from any location, talking with groups of other users or individuals as required. Mapping, presence and channel activity monitoring improve situational awareness for everyone. Mobile Communicator works on Android devices running Android 2.3 and higher and Apple devices running iOS 7.0 and higher.

WAVE Dispatch Communicator

WAVE Dispatch Communicator provides advanced VoIP dispatch features that give individual dispatchers the ability to display and manage hundreds of communications channels that make up a complex and fluid communications environment. Multiple radio channels, telephone calls and other communications systems can be patched together with just a few clicks of a mouse. Activity displays, audio recording and instant replay give dispatchers a complete session history for archiving and audit trail purposes. Dispatch Communicator requires Windows XP SP3 and IE 7 or newer.



Wave Mobile Communicator





Figure 0-25: Wave Dispatch Communicator

WAVE Desktop Communicator

WAVE Desktop Communicator allows you to access other WAVE users from your PC.

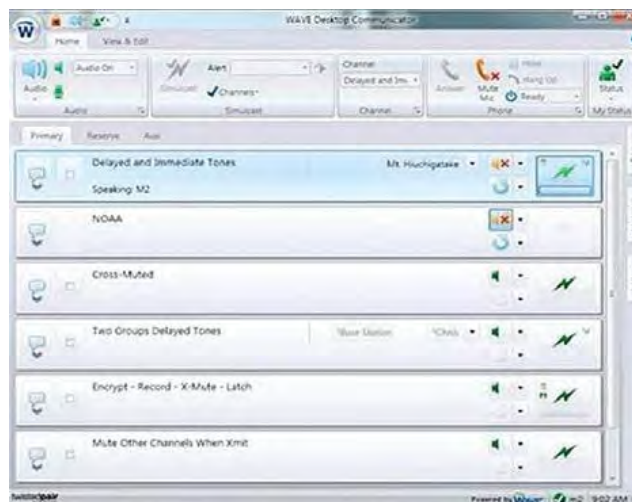

Figure 0-26: Wave Desktop Communicator

WAVE Web Communicator

WAVE Web Communicator allows you to access WAVE from a web browser.



Figure 0-27: Wave Web Communicator

2.4.1.2 WAVE System Components

WAVE Hardware

- (1) Project 25 Inter System GateWay (ISGW)
- (1) WAVE Server
- (1) Firewall

The ISGW allows the ASTRO 25 trunking system and broadband networks to connect. The WAVE server hardware hosts virtual machines to support the WAVE Management, WAVE Media & WAVE Proxy Servers.

WAVE Software and Licensing

- (1) WAVE Server license
- (25) WAVE Mobile Communicator Licenses (Android or iOS)
- (5) Channel licenses for ASTRO25 to broadband operation (one channel per talkgroup)
- (5) Channel licenses for broadband-to-broadband operation.
- (1) WAVE Desktop Communicator license
- (2) WAVE Web Communicator Licenses

2.4.2 Assumptions

Motorola Solutions has made the following assumptions in preparing this proposal. An alternate solution will need to be developed if these assumptions are not validated.

- The WAVE server will reside on the MetroSafe network.
- Any site/location upgrades or modifications are the responsibility of Louisville.
- The demarcation point for the WAVE server architecture will be an RJ-45 connection on the WAVE firewall. A connection to the MetroSafe network will be available within 100 meters of the WAVE equipment.

Talkgroups that interface with WAVE will be unencrypted.



EVERY DEVICE. EVERY NETWORK. EVERY TEAM. CONNECTED LIKE NEVER BEFORE.

WAVE 5000

WAVE 5000 enables highly scalable, feature rich, enterprise grade push-to-talk (PTT) on broadband networks and devices so that critical, time-sensitive information flows quickly and securely between mobile workers, teams and citizens.

From two-way radios to smartphones, laptops to landlines, tablets to rugged handhelds, WAVE 5000 lets your users use the devices they already have and the networks they already subscribe to connect and talk to others both inside and outside of your communications environment.

Wherever your personnel are, whatever they do, WAVE 5000 lets them connect and communicate with simple, secure, affordable PTT.

THE RIGHT DEVICE FOR THE JOB

We understand that personnel that use a radio system for operational purposes do not need to carry a ruggedized radio handset all of the time.

Perhaps you're the Chief of Police and you want to access ASTRO 25 or TETRA digital communications from your iPhone when at a conference.

Maybe you're a government agent working undercover. Your Android smartphone and earbuds would be ideal to connect to other tactical units while keeping you inconspicuous.

For every police officer on the beat, agent on a job or for hotel workers, warehouse staff and railroad maintenance crews on shift, there are many other supporting personnel that can provide support, often life-saving assistance, with PTT communications using smartphones, tablets or PCs from any location. WAVE 5000 makes it possible.

BRIDGING TWO-WAY RADIO WITH BROADBAND NETWORKS

With WAVE 5000 you can experience game-changing functionality that lets you build and operate secure, highly-scalable solutions for today's most demanding communications environments:

Extend Radio To Broadband

Extend workforce communications beyond radio to include modern devices and broadband networks for seamless communications in any location.

Deploy Broadband PTT

Secure, 'over-the-top' PTT connecting smart devices over 3/4G LTE and WiFi networks delivers greater choice and flexibility when choosing a non-radio, carrier-independent communications solution.

Connect Radio to Radio

Connect multiple, disparate two-way radio systems and remove barriers to communication interoperability and workforce collaboration.

DATA SHEET

WAVE WORK GROUP COMMUNICATIONS
WAVE 5000

BUILDING YOUR WAVE 5000 SYSTEM

WAVE 5000 is a multi-component software platform and suite of applications for enabling the integration of existing and future communication technologies. The goal is simple – remove the technical barriers to secure instant PTT communication and enable anyone on any device to securely communicate across any IP network with any other device, in real time.

At its core, WAVE enables an almost unlimited number of simultaneous data streams within an IP network.

These streams, some for voice and some for system data, connect users and their devices so that you and your teams can enjoy a truly unified PTT communications environment that provides secure access to people, information and systems that are critical to their role and responsibilities.

The implementation required to meet this goal requires a system with tremendous technical sophistication while maintaining its ease of use and implementation flexibility.

WAVE 5000 CLIENT APPLICATIONS

WAVE Communicators Enable Your Workforce to Connect and Collaborate

Whatever the device or available network, WAVE has client applications that meet the needs of all types of users. Called WAVE Communicators, these applications provide the user interface to a WAVE communications system:

WAVE MOBILE COMMUNICATOR

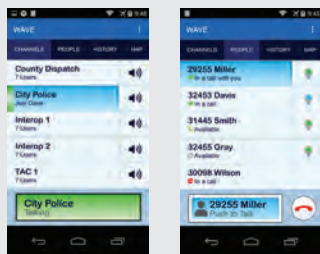

Turn Your Apple or Android Device into a Multi-Channel PTT Handset

Not everyone needs or wants to carry a radio handset. But they do want instant, secure access to important, often mission-critical communications wherever they are located.

With a WAVE Mobile Communicator installed on a smartphone, tablet or custom handheld, any user can access PTT communications from any location, talking with groups of other users or individuals as required. Mapping, presence and channel activity monitoring improve situational awareness for everyone.

WAVE DESKTOP COMMUNICATOR

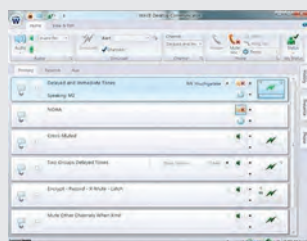

Access PTT Communications from Your Desktop PC

You're not a mobile worker in the field responding to events and service calls, but you're there to provide support from headquarters, a communications center or a remote location. Let's turn your desktop PC into a PTT communications hub.

WAVE WEB COMMUNICATOR

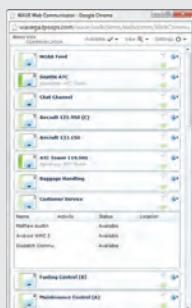

Use a Web Browser to Access Your WAVE Communications Channels

You're not at your own PC, or you cannot get to it quickly. Other PCs are available. That's when the WAVE Web Communicator comes in to its own. WAVE Web Communicator can manage more than 20 channels of secure, encrypted audio from inside a web page.

Using secure access to WAVE processing and management functionality on remote servers, in a hosted environment or as a Cloud-based service, any web browser attached to any IP network (wired or wireless) can provide access to WAVE-enabled communications.

WAVE 5000 CLIENT APPLICATIONS

WAVE Communicators Enable Your Workforce to Connect and Collaborate

Whatever the device or available network, WAVE has client applications that meet the needs of all types of users. Called WAVE Communicators, these applications provide the user interface to a WAVE communications system:

WAVE DISPATCH COMMUNICATOR



Scalable Dispatch Console Balancing Capabilities with Value

If you're a small to mid-size organization that has to balance system capabilities and performance with acquisition and operating costs, then you should consider the WAVE Dispatch Communicator for your console needs.

WAVE Dispatch Communicator provides advanced VoIP dispatch features that give individual dispatchers the ability to display and manage hundreds of communications channels that make up a complex and fluid communications environment. Multiple radio channels, telephone calls and other communications systems can be patched together with just a few clicks of a mouse. Activity displays, audio recording and instant replay give dispatchers a complete session history for archiving and audit trail purposes.

WAVE COMMUNICATOR FOR MICROSOFT LYNC AND SHAREPOINT

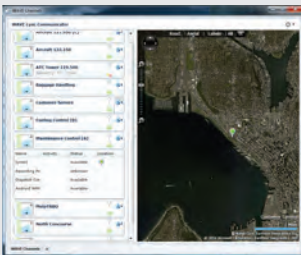

Access PTT Directly From Your Microsoft SharePoint and Microsoft Lync Communication and Collaboration Environments

As your organization grows, keeping support and administrative workers connected and collaborating effectively becomes harder. They may be required to work closely with other groups located a great distance away, or to access critical information from multiple systems that creates a sometimes unwieldy desktop experience.

Unified communications and collaboration tools from Microsoft have helped drive organizational efficiency and effectiveness through greater collaboration and easier access to important information. Microsoft Lync and Microsoft SharePoint can be enhanced with WAVE plugins that allow them to display WAVE communications channels directly on the desktop.

WAVE 5000 Minimum System Requirements

WAVE Communicator	Mobile	Desktop	Web	Dispatch	SharePoint	Lync
Device	Android Apple	PC (Desktop/Laptop)	PC (Desktop/Laptop)	PC (Desktop/Laptop)	PC (Desktop/Laptop)	PC (Desktop/Laptop)
Minimum Hardware Requirements		1.6 GHz x-86 processor 1.0 GB RAM, 100 MB HDD Accelerated GPU DirectX 9.0 with 64 MB RAM	1.6 GHz x-86 processor 1.0 GB RAM, 100 MB HDD Accelerated GPU DirectX 9.0 with 64 MB RAM	1.6 GHz x-86 processor 1.0 GB RAM, 100 MB HDD Accelerated GPU DirectX 9.0 with 64 MB RAM	1.6 GHz x-86 processor 1.0 GB RAM, 100 MB HDD Accelerated GPU DirectX 9.0 with 64 MB RAM	1.6 GHz x-86 processor 1.0 GB RAM, 100 MB HDD Accelerated GPU DirectX 9.0 with 64 MB RAM
OS Requirements	iOS 7.0 and higher Android 2.3 and higher	Windows XP Pro, SP3	Windows XP Pro, SP3	Windows XP Pro, SP3	Windows XP Pro, SP3	Windows XP Pro, SP3
App Store download	Apple App Store Google Play					
Platform Requirements					SharePoint Server 2007 & 2010	Lync Server 2010
Browser Requirements			Internet Explorer 7 or higher Mozilla Firefox 3.6 or higher Chrome 10 or higher		Internet Explorer 7 or higher Mozilla Firefox 3.6 or higher Chrome 10 or higher	Internet Explorer 7 or higher Mozilla Firefox 3.6 or higher Chrome 10 or higher
Network	3/4G public LTE & WiFi	LAN/WAN/WiFi	LAN/WAN/WiFi	LAN/WAN/WiFi	LAN/WAN/WiFi	LAN/WAN/WiFi

DATA SHEET

WAVE WORK GROUP COMMUNICATIONS
WAVE 5000

DEPLOYING WAVE 5000

Your organization can choose how it wants to deliver WAVE enabled communications

For the majority of deployments, hosted solutions, where WAVE software is installed and runs on your server hardware, is normal. This is particularly true when organizations are particularly sensitive to network and data security, or when organizations have extensive investments and capacity in IT infrastructure.

An alternative approach puts WAVE applications in the Cloud where they are accessed over a private network. Cloud-based PTT services offer compelling benefits, such as access to the latest WAVE software releases and significantly lower IT costs.

Motorola gives you choices. WAVE communications can be delivered either way – on premise or via the Cloud - giving you the flexibility to scale, deploy and support your communications efficiently and effectively as your organization's needs grow.

WAVE 5000 Summary	
Customer Markets	Public Safety / Federal Commercial
Radio Integrations*	Motorola ASTRO® 25 Motorola TETRA Dimetra IP Motorola MOTOTRBO™
Broadband User Capacity	3,000
WAVE Communicators	Mobile Desktop Web Dispatch Microsoft SharePoint Microsoft Lync
Mobile Device Support	Consumer grade iOS and Android Motorola LEX ruggedized handhelds
Other Attributes	IP PBX integration
* Motorola Solutions focus areas. Other radio systems via donor radio and gateways.	



For more information on WAVE 5000, go to motorolasolutions.com/WAVE

For more information on WAVE Workgroup Communication solutions, go to motorolasolutions.com/WAVE

Motorola Solutions, Inc.
1301 East Algonquin Road Schaumburg, Illinois 60196, U.S.A.
800-367-2346 motorolasolutions.com

MOTOROLA, MOTO, MOTOROLA SOLUTIONS and the Stylized M Logo are trademarks or registered trademarks of Motorola Trademark Holdings, LLC and are used under license. All other trademarks are the property of their respective owners. © 2015 Motorola Solutions, Inc. All rights reserved. R3-4-5011





PARTICIPATE IN CRITICAL COMMUNICATIONS FROM YOUR DESKTOP PC

WAVE[®] DESKTOP COMMUNICATOR

The WAVE Desktop Communicator is Motorola's most widely deployed critical communications application, with thousands of clients in daily use around the world supporting military, federal government and commercial organizations.

Desktop Communicator is a feature-rich software application that allows office-based or mobile workers to use their desktop or laptop PC to monitor, transmit, and receive audio from multiple communication systems such as two-way radio networks and telephones. With an intuitive and easy to use display that uses the latest Microsoft Ribbon Control technology, Desktop Communicator runs on virtually any PC from multi-processor desktop machines to Netbooks.

POWERFUL AND PORTABLE

Desktop Communicator can manage more than 100 channels of secure, encrypted audio on a standard laptop computer, and because it utilizes the machine's CPU for all of its audio processing, no additional specialized or proprietary hardware is required. This minimal hardware requirement also means that Desktop Communicator can go anywhere. Simply connect the PC to a network (wired or wireless) and the user can monitor and fully participate in critical communications. The application runs in the background enabling users to manage other tasks while still monitoring audio from multiple channels. Status bar pop-ups help by providing a visual indication of activity.

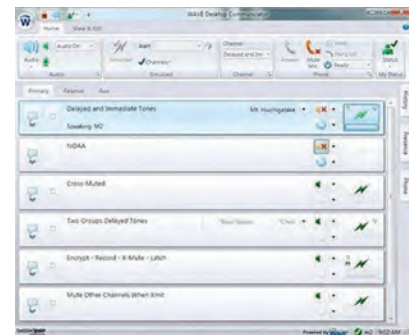

DATA SHEET

WAVE BROADBAND PTT: DESKTOP COMMUNICATOR



INTUITIVE AND FLEXIBLE

Desktop Communicator can be run in a variety of user defined modes. Fly out panels that offer Presence, History and Softphone interfaces can be exposed when needed and hidden when not required. In addition each of the panels can be detached and pinned anywhere on the user's screen. The entire Ribbon Control can be hidden to maximize the amount of screen used for channel activity and the entire channel area can be managed with a zoom control to make channels as large or small as desired.

INTELLIGENT, CUSTOMIZABLE DESIGN

Intended for users who do not have dispatch responsibilities, a Desktop Communicator client runs as a standalone Windows program. Each time a user logs off the system, preferences are saved by the controlling WAVE Management Server so that at the time of the next login Desktop Communicator will open the same way as it was closed – regardless of the machine being used. Desktop Communicator is designed to be easily localized into any language.

WAVE DESKTOP COMMUNICATOR KEY BENEFITS

TESTED AND TRUSTED

WAVE Desktop Communicator is the industry's most widely deployed and battle-tested IP Dispatch console.

FLEXIBLE AND SCALABLE

Operators can deploy, redeploy and provision instantaneous back-up services using WAVE Desktop Communicators running on off-the-shelf PCs without the added cost of filling a back room with servers and networking gear.

EFFICIENT AND PRODUCTIVE

Individual users can display and manage an unlimited number of channels that make up a customizable, complex and fluid communications environment.

FULL AUDIO HISTORY

Activity displays, audio recording and instant replay give operators a complete session history for archiving and audit trail purposes.

ENHANCED COLLABORATION

Text messaging and intercom between multiple WAVE Desktop Communicator consoles and other WAVE-enabled applications improves situational awareness and dispatcher effectiveness.

PUSH-TO-TALK CLOUD SERVICES

Securely connect teams of mobile workers with a network independent, over-the-top (OTT) push-to-talk solution. Use ours, or build your own cloud with WAVE.

DATA SHEET

WAVE BROADBAND PTT: DESKTOP COMMUNICATOR

PUSH-TO-TALK (PTT)

- Transmit (PTT) on group, individual and emergency calls
- Instant Transmit
- Left-right audio panning on stereo output devices
- Selection of audio devices to be associated with individual channels
- Selection of an audio device to be associated with all channels
- Audio routing between headset and speaker
- Broadcast – Simultaneous transmit across multiple channels
- Pre-defined alert tones and recordings
- PTT ID/alias
- Instant Replay, allowing play back of audio on a channel
- Option to save Instant Replay to disk
- Channel latch
- Radio-specific hot keys for WAVE channels that map to radio systems
- Selection of separate microphone and speaker devices on a channel-by-channel basis or across all channels

TELEPHONY

- Supports H.323 and SIP
- 8 simultaneous phone lines per position
- Answer/release
- Transfer
- Conference
- Hold/Mute
- Last number dialed

SYSTEM

- Status and presence of all endpoints per channel and system-wide
- System tray “pop ups” provide a visual indicator of channel communications
- Group text messaging
- Per-channel call history
- System-wide call history
- Actionable history – see a missed transmission and click for instant replay
- An activity record, which graphically depicts activity on a channel for a user-defined period
- Console-to-console intercom
- Master-console volume adjustment
- Mute All
- Channel recording
- Status messages
- Aux I/O controls
- Network Health Monitor
- Selection of network interface to use for transmission – ideal for users who have multi-homed machines or who are accessing the corporate network via VPN or dialup connections
- Ability to use “free-seating”. This allows users to logon to WAVE from any computer and have their settings and preferences automatically downloaded for them.
- Organize channels by tabs
- Receive audio from all channels using only 1 IP stream on the network
- Network Troubleshooting indicator and connection wizard
- Microsoft Ribbon Control technology
- Zoom control – adjust channel size as needed
- Bing maps
- Sat location
- Section 508 compliant

MINIMUM HARDWARE REQUIREMENTS

OS: Windows XP Professional, SP3
CPU: 1.6 GHz x-86 based processor
Internal Memory: 1.0 GB RAM
Available Storage: 100 MB

Controller: 100 Mbps
Video Card: 3D Accelerated, GPU with DirectX 9.0 with 64 MB RAM
Software: Microsoft Internet Explorer 6
Peripherals: 2 Speakers, 1 microphone

DATA SHEET

WAVE BROADBAND PTT: DESKTOP COMMUNICATOR



OTHER WAVE APPLICATIONS

WAVE Dispatch Communicator is a state-of-the-art IP dispatch console system designed for critical communications dispatch applications. Dispatch Communicator provides a console operator with full dispatch functionality via an intuitive, easy-to-use desktop client running on a single, industry-standard PC.

WAVE Mobile Communicator allows smartphone users to access Push-to-Talk (PTT) radio channels from their phones, converting devices they always carry with them into inexpensive alternatives to expensive mobile radios.

WAVE Web Communicator is a feature-rich web application that allows any office-based or mobile worker to monitor, transmit, and receive audio from multiple communication systems such as two-way radio networks and telephones using a browser-based application.

To learn more about WAVE Desktop Communicator, contact your Motorola representative or visit motorolasolutions.com/WAVE.

Motorola Solutions, Inc. 1301 East Algonquin Road Schaumburg, Illinois 60196, U.S.A. 800-367-2346 motorolasolutions.com

MOTOROLA, MOTO, MOTOROLA SOLUTIONS and the Stylized M Logo are trademarks or registered trademarks of Motorola Trademark Holdings, LLC and are used under license. All other trademarks are the property of their respective owners. © 2014 Motorola Solutions, Inc. All rights reserved. R3-13-2017



2.5 MUTUAL AID ANALOG CONVENTIONAL SIMULCAST SYSTEM IP UPGRADE

Motorola Solutions is proposing an upgrade for the Louisville Mutual Aid analog conventional simulcast system. The proposed solution will migrate all three 800MHz channels of the existing system from circuit connectivity to an IP network. The system topology will remain the same; it will be composed of one prime site and five remote sites.

Simulcast System Component Descriptions

Each site type in the system contains various components. Components included in this system design are described in this section.

MLC 8000 Comparator/Gateway

The MLC 8000 enables circuit/IP site link combinations for voting and simulcast systems. The MLC 8000 can be configured as an analog comparator or an analog IP gateway and it supports the following functions:

- Interfaces directly with existing analog TRC consoles
- Interfaces directly with existing analog 4-wire base stations and receivers
- Supports Analog Simulcast over IP subsite links
- Supports Analog Simulcast over circuit subsite links
- Supports Analog Voting (non-simulcast) over any combination of circuit or IP subsite links
- Supports Analog Voting and Simulcast operation on the ASTRO® 25 K and M Core solutions with the MCC 7500
- Supports Conventional Analog Voting and Simulcast channels on ASTRO® 25 trunking solutions

The MLC 8000 supports voting and simulcast system configurations, and is fully compatible with G-Series base station / receivers and several of Motorola's other analog base station and receiver products.

GTR 8000 Base Station

The conventional GTR 8000 Base Radio provides the interface between mobile/subscriber radios that access the system on the APCO 25 FDMA Common Air Interface and the rest of the ASTRO® 25 Conventional system.

G-series site equipment products are very flexible and designed to support today's robust site designs. G-series site equipment products provide the flexibility to upgrade to future functionality through software downloads.

Network Equipment

The GGM 8000 Gateway and HP 2620 LAN switch have been included to provide the IP interface for the conventional simulcast system. The network equipment will carry all voice and network management traffic between the simulcast prime and remote sites.

2.5.1 System Components

Prime Site - MICCS

The prime site contains the prime site MLC 8000 comparators and networking equipment to interface to the remote simulcast sites. The prime site will also be the central point of the network and



will connect to each RF site through microwave network. The equipment for the prime site includes:

- Three (3) MLC 8000 Comparators
- One (1) 7.5' Equipment Rack
- One (1) GGM 8000 Site Gateway
- One (1) HP 2620 Site LAN Switch

Remote Site –Bardstown, MSD, FCFD #2, and Waverly Hill

The remote sites will contain the transmitters and receivers for the simulcast system. The existing QUANTARs will be replaced with GTR 8000 stations but will use the existing RFDS (Radio Frequency Distribution System), antennas and transmission lines. The equipment for each remote site includes:

- Three (3) MLC 8000 Gateways
- Three (3) GTR 8000 800MHz Base Stations
- One (1) 7.5' Equipment Rack
- One (1) GGM 8000 Site Gateway
- One (1) HP 2620 Site LAN Switch
- One (1) AC-DC Power Inverter

Note: Spares have not been included in this proposal.



2.5.2 System Diagram

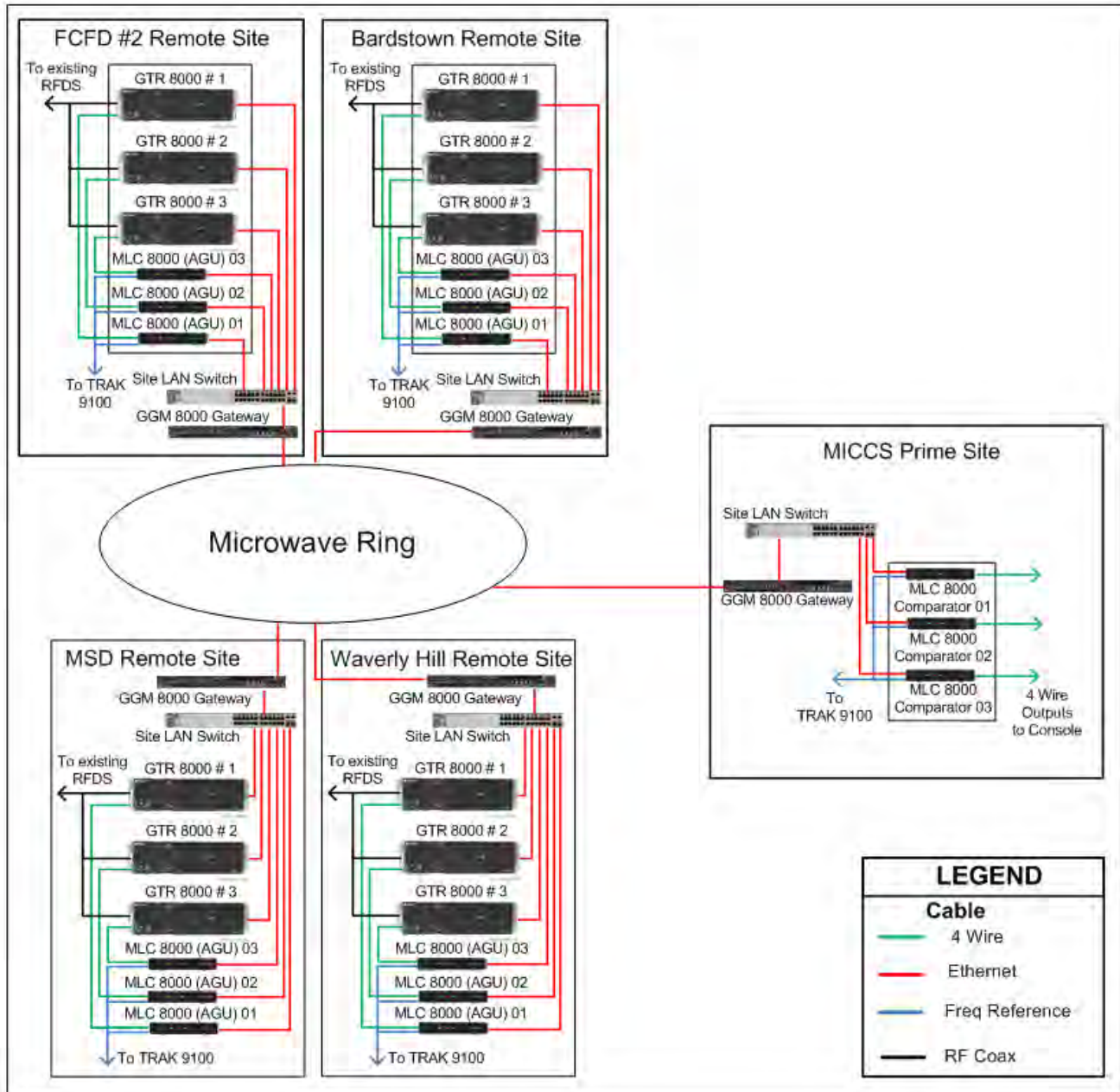

Figure 0-28: System Block Diagram

2.5.3 Assumptions

Motorola Solutions has made several assumptions in preparing this proposal. Motorola will need to verify all assumptions or seek alternate solutions in the case of invalid assumptions.

- The existing sites have sufficient main and backup power at all the sites.
- All existing sites or equipment locations will have sufficient space for one rack of equipment.
- All existing sites or equipment locations will have adequate electrical power and be R56 compliant.

- Any site/location upgrades or modifications are the responsibility of the Customer.
- Each site will use the microwave network for site connectivity. The interface to the microwave network will be less than 100 meters to the proposed equipment rack and will interface have one RJ-45 Ethernet port available.
- This proposal assumes only the mutual aid analog conventional simulcast system is purchased. If the FSA or VHF paging system is purchased simultaneously, it is possible a few network components can be removed in overlapping sites.

2.6 CONVENTIONAL VOTING

Motorola Solutions is proposing an upgrade for the Louisville analog conventional voting systems. The proposed solutions will migrate the six UHF and VHF channels of the existing system from circuit connectivity to an IP network.

Simulcast System Component Descriptions

Each site type in the system contains various components. Components included in this system design are described in this section.

MLC 8000 Comparator/Gateway

The MLC 8000 enables circuit/IP site link combinations for voting and simulcast systems. The MLC 8000 can be configured as an analog comparator or an analog IP gateway and it supports the following functions:

- Interfaces directly with existing analog TRC consoles
- Interfaces directly with existing analog 4-wire base stations and receivers
- Supports Analog Simulcast over IP subsite links
- Supports Analog Simulcast over circuit subsite links
- Supports Analog Voting (non-simulcast) over any combination of circuit or IP subsite links
- Supports Analog Voting and Simulcast operation on the ASTRO® 25 K and M Core solutions with the MCC 7500
- Supports Conventional Analog Voting and Simulcast channels on ASTRO® 25 trunking solutions

The MLC 8000 supports voting and simulcast system configurations, and is fully compatible with G-Series base station / receivers and several of Motorola's other analog base station and receiver products.

GTR 8000 Base Station

The conventional GTR 8000 Base Radio provides the interface between mobile/subscriber radios that access the system on the APCO 25 FDMA Common Air Interface and the rest of the ASTRO® 25 Conventional system.

Network Equipment

The GGM 8000 Gateway and HP 2620 LAN switch have been included to provide the IP interface for the conventional simulcast system. The network equipment will carry all voice and network management traffic between the simulcast prime and remote sites.

GPW 8000 Receiver

The receiver provides all the receive function of a GTR 8000 Base Radio as a receive-only station in a Conventional Architecture or ASTRO® 3.1 Conventional System. The receiver operates in a voting environment with connection to a comparator providing additional receive only stations in areas

where it would otherwise be difficult to receive a signal from low power subscriber units. The receiver also operates as a monitor receiver in a non-voting environment with connection to a console.

2.6.1 System Components

Network Equipment

The analog conventional voting channels share the same five receive-only sites, and one of the two transmit sites. To upgrade any or all of the analog conventional channels to IP, the following network components will be required:

- Seven (7) HP LAN Switches
- Seven (7) GGM 8000 Gateways
- Seven (6) 7.5 Foot Equipment Racks
- One (1) 7 Foot Equipment Rack (Delta Dental)
- One (1) Conventional Channel Gateway

MED-10

The MED-10 voting system has currently has one MASTRIII base station at the Old Mitchell Hill site and one GPW 8000 Receiver at the MSD, Bardstown, Waverly, Delta Dental, and FCFD sites. To migrate the system to an IP network the following equipment has been included:

- One (1) MLC 8000 Voting Comparator
- Six (6) MLC 8000 Gateways
- One (1) GTR 8000 UHF Base Station
- One (1) UHF Booster Amplifier

Urban-5

The Urban-5 voting system has currently has one MASTRIII base station at the Bardstown Road site and one GE Receiver at the MSD, Waverly, Delta Dental, and FCFD sites. To migrate the system to an IP network the following equipment has been included:

- One (1) MLC 8000 Voting Comparator
- Four (5) MLC 8000 Gateways
- One (1) GTR 8000 UHF Base Station

Urban Fire 1

The Urban Fire 1 voting system has currently has one MASTRIII base station at the Bardstown Road site and one GPW 8000 Receiver at the MSD, Waverly, Delta Dental, and FCFD sites. To migrate the system to an IP network the following equipment has been included:

- One (1) MLC 8000 Voting Comparator
- Five (5) MLC 8000 Gateways
- One (1) GTR 8000 UHF Base Station
- Four (4) GPW 8000 UHF Receiver

VHF Mutual Aid

The VHF Mutual Aid voting system has currently has one GTR base station at the Old Mitchell Hill site and one GPW 8000 Receiver at the MSD, Waverly, Delta Dental, Bardstown, and FCFD sites. To migrate the system to an IP network the following equipment has been included:



- One (1) MLC 8000 Voting Comparator
- Six (6) MLC 8000 Gateways

F3 Suburban

The F3 Suburban voting system has currently has one GTR base station at the Old Mitchell Hill site and one GPW 8000 Receiver at the MSD, Waverly, Delta Dental, Bardstown, and FCFD sites. To migrate the system to an IP network the following equipment has been included:

- One (1) MLC 8000 Voting Comparator
- Six (6) MLC 8000 Gateways

Vtac

The Vtac voting system has currently has one GTR base station. It is assumed the GTR is located at the Bardstown site and one GPW 8000 Receiver at the MSD, Waverly, Delta Dental, and FCFD sites. To migrate the system to an IP network the following equipment has been included:

- One (1) MLC 8000 Voting Comparator
- Five (1) MLC 8000 Gateways
- One (1) GTR 8000 VHF Base Station
- One (1) VHF Booster Amplifier

Fern Creek Antenna System

A new VHF and new UHF receive antenna network are included to support the receivers at the Fern Creek site.

- One (1) VHF receive antenna system including transmission line
- One (1) 8-port VHF RX Multicoupler
- One (1) UHF receive antenna system including transmission line
- One (1) 8-port UHF RX Multicoupler

Note: Spares have not been included in this proposal.

2.6.2 System Diagram

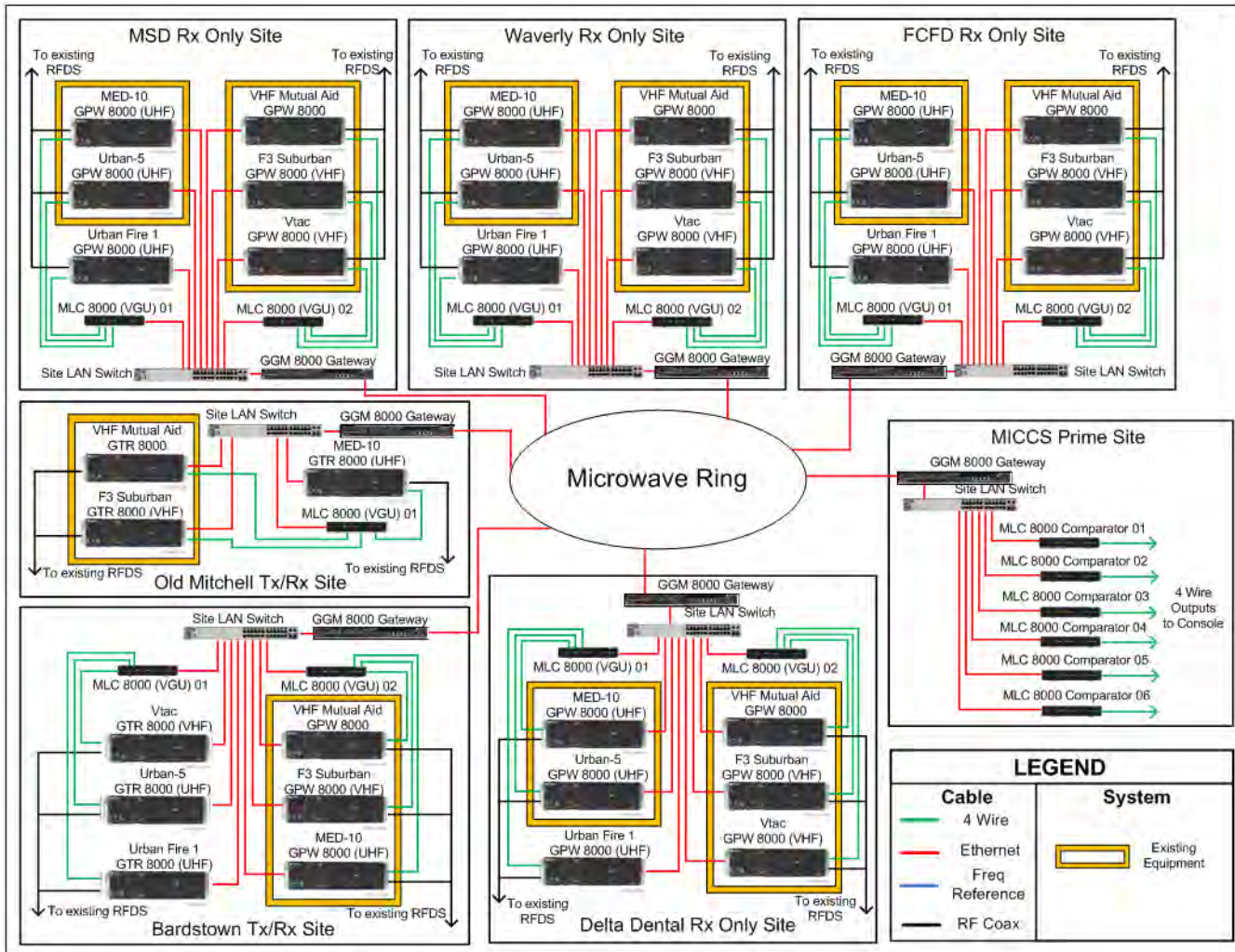

Figure 0-29: System Block Diagram

2.6.3 Assumptions

Motorola Solutions has made several assumptions in preparing this proposal. Motorola will need to verify all assumptions or seek alternate solutions in the case of invalid assumptions.

- The existing sites have sufficient main and backup power at all the sites. All equipment will be powered by AC.
- All existing sites or equipment locations will have sufficient space for one rack of equipment.
- All new base stations will reuse existing transmission line, antenna, and any other RFDS equipment with the exception of the two new antennas at the Fern Creek site.
- All existing sites or equipment locations will have adequate electrical power and be R56 compliant.
- Any site/location upgrades or modifications are the responsibility of the Customer.

- Each site will use the microwave network for site connectivity. The interface to the microwave network will be less than 100 meters to the proposed equipment rack and will interface have one RJ-45 Ethernet port available.

The Vtac base station will be installed at the Bardstown site.

2.7 CUTOVER PLAN

Migrating the system from release 6.9 to 7.15 is a process that will require detailed planning of personnel resources. This section provides a conceptual overview of the cutover process.

2.7.1 Phase 1: Staging and Installation

Step 1-1: Install Microwave Overbuild for IP + TDM Transport Network

A new, native IP microwave network will be “overbuilt” on top of the existing OC-3 network by obtaining a 2nd set of frequencies for each microwave hop. If suitable frequencies are not available for a particular hop, a second set of antennas/waveguide will be required. The new microwave network will be built out and tested without significant impact to the current OC-3 network.

Step 1-2: Stage and Install Master Site Equipment

The 7.15 Master Site, the two prime sites, simulcast network equipment for 13 sites, dispatch site network equipment, and logging recorder will all be staged as a system at Motorola’s facility in Schaumburg, IL. An acceptance test will be conducted in staging. The staged system will be shipped to Louisville and be physically installed in the same room as the current Master Site equipment.

Step 1-3: Install Prime Site equipment and networking equipment at 13 Simulcast Remote Sites

The two new prime sites will be installed at Bardstown Rd and Waverly Hill. Networking equipment which consists of (2) routers and (2) Ethernet switches at each subsite will be physically installed, powered up and connected to the new Ethernet WAN.

Step 1-4: Install NICE Logging recorder

The NICE logging recorder can be tested once MetroSafe’s NICE Inform is upgraded to v5.1 and the Customer Network Interface (CNI) is established between MetroSafe and the Motorola radio network.

Step 1-5: Install VPM Dispatch Consoles

Working with MetroSafe, a specific number of new MCC7500 VPM-based consoles will be installed. These positions will be connected to the new 7.15 system for acceptance testing. They will also be connected to control stations to support wireless dispatch just prior to the cutover.

Step 1-6: Customer Network Interface Prep

To the extent possible, make connections between the MetroSafe network and the Motorola radio network. This includes the MCC7500 CAD interface, NICE Inform interface, and Genesis ATIA data.

Step 1-7: Migrate (3) simulcast channels to new system on dummy loads

At the Bardstown Rd site (3) simulcast channels (1 control and 2 voice) will be disconnected from the 6.9 system, be placed on dummy loads (to avoid transmitting over the air) and will be cut over to the

new 7.15 system for testing. These (3) channels at the remaining simulcast remote sites will be disabled. This will serve as a trial run for the full cutover procedure.

2.7.2 Phase 2: Acceptance Testing

Step 2-1: Acceptance Test Plan

A functional acceptance test plan will be executed to ensure that the system is ready for live traffic. This will involve the entire Master Site, dispatch sites with new VPM consoles, the (3) channels at Bardstown Rd and mobiles/portables.

2.7.3 Phase 3: Cutover

Step 3-1: Logistics

The cutover sequence will require careful attention to personnel planning, communications planning and documentation. Personnel will need to be trained on the procedures they need to execute at their assigned sites during the cutover.

Step 3-2: Begin Wireless Dispatch from consoles

Assigned console positions will move from old to new consoles. All console positions (old and new) will begin wireless dispatch operation (via control stations). They will dispatch wirelessly on their normal talkgroups for the duration of the cutover (~ 6-8 hrs)

Step 3-3: Cut 50% of simulcast channels from old to new system

When all personnel are in place and the decision is made to begin the cutover, 50% of the channels on the 6.9 system will be administratively disabled. The 7.15 simulcast cell will be administratively placed in a “Site Off” state so that it does not broadcast a control channel. Personnel at the 13 remote sites will unplug the 12 channels from the old Ethernet switches, re-IP the GTR base stations and plug them in to the new Ethernet switches. IP connectivity to the 12 channels at all sites will be verified. A software upgrade will then be pushed to all 12 channels (156 base stations). Once the upgrade is complete, the 6.9 simulcast cell (12 channels) will be administratively disabled and the 7.15 cell (12 channels) will be enabled. Users may experience a few seconds of outage while they find the new 7.15 control channel. Users will also need to go through re-affiliation the first time they PTT on the new system causing a slight delay in PTT.

Step 3-4: Migrate Remaining 50% of simulcast channels to new system

After a testing period to ensure that users are not experiencing any problems and all equipment is functioning correctly, another go/revert decision will be made. If the decision is “go”, the 6.9 simulcast cell will be turned off and the remaining 12 channels will be migrated to the 7.15 simulcast cell.

Step 3-5: New console users resume wireline dispatch

Once the simulcast cutover is complete, the users of the new consoles can return to wireline (normal) dispatch. Users of the old consoles will continue to dispatch wirelessly until their dispatch operator position is replaced.

Step 3-6: Install remaining console positions

The remaining console positions will be physically installed and connected to the 7.15 system.

Step 3-7: MOSCAD upgrade

Upgrade and integration of the MOSCAD and NMO discovery.

Step 3-8: Cutover complete



EXHIBIT C-2

EQUIPMENT LIST

METROSAFE COMMUNICATIONS MIGRATION PLAN

FEBRUARY 2015



The design, technical, pricing, and other information ("Information") furnished with this submission is proprietary information of Motorola Solutions, Inc. ("Motorola") and is submitted with the restriction that it is to be used for evaluation purposes only. To the fullest extent allowed by applicable law, the Information is not to be disclosed publicly or in any manner to anyone other than those required to evaluate the Information without the express written permission of Motorola.

MOTOROLA, MOTO, MOTOROLA SOLUTIONS, and the Stylized M Logo are trademarks or registered trademarks of Motorola Trademark Holdings, LLC and are used under license. SYMBOL is a trademark owned by Symbol Technologies, Inc., which is a wholly owned subsidiary of Motorola Solutions, Inc. All other trademarks are the property of their respective owners. © 2013 Motorola Solutions, Inc. All rights reserved.

TABLE OF CONTENTS

Exhibit C-2
Equipment List..... 1

EQUIPMENT LIST

APC	QTY	NOMENCLATURE	DESCRIPTION
877	1	SQM01SUM0273	MASTER SITE CONFIGURATION
877	1	CA02093AC	ADD: M3 SYSTEM (1-150 SITES)-1ST ZONE
877	1	CA01471AA	ADD: WINDOWS SUPPLEMENTAL TRANS CONFIG
877	1	CA02113AA	ADD: ASTRO 25 FDMA TRKG OPERATION
222	1	CA02081AC	ADD:TRUNKED INTEGRATED DATA
877	16	UA00153AA	ADD: ASTRO 25 FDMA SITE LICENSE
877	1	CA01723AD	ADD:BASELINE BACK UP
877	10	UA00156AA	ADD: MCC7500 CONSOLE LICENSES (QTY 5)
877	20	UA00152AA	ADD:500 RADIO USER LICENSES
877	19	CA02193AA	ADD: ANTI-MALWARE DEF UPDATE LIC
877	4	UA00136AA	ADD: UNIFIED NETWORK CONFIGURATOR (UNC)
877	2	UA00147AA	ADD: PROVISIONING MANAGER
877	2	UA00146AA	ADD: UNIFIED EVENT MANAGER (UEM)
877	1	UA00143AA	ADD: SECURITY PARTITIONING
877	1	UA00138AA	ADD: FLEXIBLE ATIA
772	1	ZA00103AA	ENH: TECHNICAL ASSISTANCE, TEN HOURS
877	1	UA00142AA	ADD: CADI SOFTWARE OPTION
772	1	ZA00104AA	ENH: TECHNICAL ASSISTANCE, FORTY HRS
877	4	UA00141AA	ADD: ZONEWATCH GRID & CTRL
877	4	UA00144AA	ADD: ZONE HISTORICAL RPTS
877	1	UA00150AA	ADD: DYNAMIC REPORTS
877	4	UA00149AA	ADD: RADIO CONTROL MANAGER
877	4	UA00151AA	ADD: AFFLIATION USER RPTS
382	2	CA02634AA	ADD: MOSCAD NFM VIRTUAL APP A7.15_A3.1
469	2	F4544	SITE MANAGER ADVANCED
469	2	V266	ADD: 90VAC TO 260VAC PS TO SM
469	2	VA00873	ADD: SDM SNT FW CURR ASTRO REL
708	2	TT2565	NM Z420 HIGH TIER WIN7-IE9 64BIT
708	2	DS019BLK	19 INCH NON-TOUCH MONITOR, BLACK
708	2	TT2177	INTOUCH RUNTIME 60K TAG W/O-I/O, V10.1, LIC ONLY
708	2	TT2296	HYPERACCESS VERSION 9.0
708	2	DDN9048	SERIAL/ IP 1 PORT SEAT LICENSE
708	2	TT2539	Z420 HIGH TIER WORKSTATION WINDOWS
877	2	T8123	ASTRO CLIENT APPL SW 7.15
708	2	DS019BLK	19 INCH NON-TOUCH MONITOR, BLACK



APC	QTY	NOMENCLATURE	DESCRIPTION
147	1	SQM01SUM0205	GGM 8000 GATEWAY
147	1	CA01616AA	ADD: AC POWER
708	68	T7885	MCAFFEE WINDOWS AV CLIENT
877	87	T7449	WINDOWS SUPPLEMENTAL TRANS CONFIG
147	1	CLN1856	2620-24 ETHERNET SWITCH
147	1	SQM01SUM0205	GGM 8000 GATEWAY
147	1	CA01616AA	ADD: AC POWER
232	1	SQM01SUM0257	UNIFIED NETWORK SERVICES
232	1	CA02384AB	ADD: UNIFIED NETWORK SERVICES SOFTWARE
232	1	CA02354AA	ADD: ASTRO NETWORK APPLICATION INTERFACE
232	1	CA02362AA	ADD: MCAFFEE STANDALONE ANTI VIRUS SOFTWARE
232	1	CA02358AA	ADD: ASTRO NETWORK SERVER
232	1	CA02053AA	ADD: Supplemental CD Transparent IA on Presence and/or Location
232	1	UA00058AA	ADD: 0-100 DEVICES FOR PRESENCE
147	1	SQM01SUM0238	SRC7500 SWITCHING ROUTING CENTER (7.13 AND BEYOND)
147	1	CA02652AA	ADD: SRC 7500 FOR 7.15 AND BEYOND
147	1	CA02194AA	HIGH TIER CORE LAN SWITCHES (HP3800 - 96 PORTS)
147	1	CA01345AA	ADD: DUAL GATEWAY ROUTERS STANDARD
147	1	CA01346AA	ADD: QTY 1 PAIR CORE ROUTERS CWR
147	1	CA01350AA	ADD: QTY 1 PAIR CORE ROUTERS ETH
147	1	CA01354AA	ADD: DUAL LINK 1 PAIR CWR
147	1	CA01360AA	ADD: CORE BACKHAUL SWITCHES
147	1	CA01361AA	ADD: GGSN
708	3	DSSTBP8000100	SEAGATE : 8TB BUSINESS STORAGE 4-BAY NAS
207	4	DSFF1P112CC22	CHATSWORTH F-SERIES TERAFRAME CABINET. TWO-POINT, CAM LATCH, KEYED
226	1	SQM01SUM0227	ISGW SERVER USED FOR ISSI / CSSI
147	1	T8126	FORTINET FIREWALL APPLIANCE
660	1	SQM01SUM0284	Wave Server
892	1	TT2789	NEW WAVE SYSTEM
892	1	TT2775	SOFTWARE,WAVE SERVER LICENSING
892	5	TT2776	WAVE COMMUNICATION CHANNEL-NO RADIO SYSTEM INTEGRATION
892	5	TT2777	WAVE COMMUNICATION CHANNEL-WITH RADIO SYSTEM INTEGRATION
892	1	TT2779	WAVE DESKTOP COMMUNICATOR-INCLUDES PLUG-IN-PANEL
892	2	TT2784	WAVE WEB COMMUNICATOR
892	25	TT2782	WAVE MOBILE COMMUNICATOR ANDROID & IOS

APC	QTY	NOMENCLATURE	DESCRIPTION
892	1	TT2820	SOFTWARE,WAVE RADIO GATEWAY SOFTWARE
892	1	CVN7053	ASTRO 25 TO WAVE INTERFACE LICENSE
147	1	CLN1856	2620-24 ETHERNET SWITCH
280	1	DLN6822	FRE: DL380p G8 HC 300GB DISK
280	1	DLN6864	FRU: DL380 G8p POWER SUPPLY
056	1	DLN6940	460W POWER SUPPLY FOR DL380P
280	2	DLN6844	CPH 300 GB HARD DRIVE
280	2	DLN6866	DVD DRIVE
877	1	DLN6880	DAS - CHASSIS ONLY
877	15	DLN6878	DAS - 600 GB SAS HARD DRIVE
877	2	DLN6879	DAS - PROCESSOR MODULE
877	2	DLN6867	DAS POWER SUPPLY
877	4	CKN6952	SAS CABLE 1M
147	1	SQM01SUM0205	GGM 8000 GATEWAY
147	1	CA01619AA	ADD: DC POWER
147	1	SQM01SUM0205	GGM 8000 GATEWAY
147	1	CA01616AA	ADD: AC POWER
147	1	CLN1856	2620-24 ETHERNET SWITCH
147	1	CLN1858	3800-48 ETHERNET SWITCH
147	1	CLN1857	HP X311 REDUNDANT POWER SUPPLY
147	1	T8126	FORTINET FIREWALL APPLIANCE
660	1	DLN6967	FRU: 500 GB SATA DRIVE
147	1	CLN8489	48 PORT TERMINAL SERVER
147	2	ST6018	S6000 12 PORT T1/E1 II MODULE
147	1	T7380	CO-OP WAN ROUTER RELAY PANEL
147	1	ST6011	S6000 4-PORT FLEXWAN MODULE
147	1	DKN6144A	ASSY,CBL,3 FT,RELAY PNL,CWR,S6000
424	1	DLN6742	460 WATT POWER SUPPLY
424	1	DLN6744	300 GB SAS HARD DISK DRIVE
424	1	DLN6745	DVD-RW SATA DRIVE (DL360)
443	1	B1905	MCC 7500 ASTRO 25 SOFTWARE
443	13	B1933	MOTOROLA VOICE PROCESSOR MODULE
443	13	CA01642AA	ADD: MCC 7500 BASIC CONSOLE FUNCTIONALITY SOFTWARE LICENSE
443	13	CA01643AA	ADD: MCC 7500 / MCC 7100 TRUNKING OPERATION
443	13	CA00147AF	ADD: MCC 7500 SECURE OPERATION
443	13	CA00182AB	ADD: AES ALGORITHM
443	13	CA00245AA	ADD: ADP ALGORITHM
443	13	CA00140AA	ADD: AC LINE CORD, NORTH AMERICAN



APC	QTY	NOMENCLATURE	DESCRIPTION
443	26	B1912	MCC SERIES DESKTOP SPEAKER
443	26	B1913	MCC SERIES HEADSET JACK
708	13	DSTWIN6328A	PROVIDES ONE DUAL PEDAL FOOTSWITCH FOR USE WITH MOTOROLA MCC 7500 DISP
708	13	TT2538	Z420 LOW TIER WORKSTATION WINDOWS 7
877	13	T7449	WINDOWS SUPPLEMENTAL TRANS CONFIG
708	13	T7885	MCAFFEE WINDOWS AV CLIENT
229	13	DDN1245	DUAL IRR SW USB HASP WITH LICENSE (VERSION 45)
229	13	DDN1118	REPL BY DQSBAUDIGYRX - PCI EXPRESS SOUND BLASTER X-FI XTREME AUDIO
708	13	CDN6673	CREATIVE LABS INSPIRE A60
147	2	CLN1856	2620-24 ETHERNET SWITCH
147	2	SQM01SUM0205	GGM 8000 GATEWAY
147	2	CA01616AA	ADD: AC POWER
147	3	SQM01SUM0205	GGM 8000 GATEWAY
147	3	CA01616AA	ADD: AC POWER
147	3	CA02086AA	ADD: HIGH DENSITY ENH CONV GATEWAY
443	1	B1905	MCC 7500 ASTRO 25 SOFTWARE
443	1	B1933	MOTOROLA VOICE PROCESSOR MODULE
443	1	CA00288AB	ADD: MCC 7500 ARCHIVING INTERFACE SERVER SOFTWARE LICENSE
443	1	CA00147AF	ADD: MCC 7500 SECURE OPERATION
443	1	CA00182AB	ADD: AES ALGORITHM
443	1	CA00245AA	ADD: ADP ALGORITHM
443	1	CA00140AA	ADD: AC LINE CORD, NORTH AMERICAN
708	1	T7885	MCAFFEE WINDOWS AV CLIENT
708	1	TT2538	Z420 LOW TIER WORKSTATION WINDOWS 7
708	1	DS2702965	HP XW4/Z2/Z4 DEPTH ADJUSTABLE FIXED RAIL RACK KIT (WH340AA)
229	1	TT2669	120 SIMUL CALL MCC 7500 IP RECORDER
229	1	TT05717AA	ADD: IP LOGGING RECORDER FOR USE ON 7.14 SYSTEMS
229	1	TT05783AA	ADD: 120 SIMULTANEOUS CALL REDUNDANT MCC 7500 IP LOGGING RECORDER
229	2	DQCLSHDEXPAN	HP 300GB 6G SAS 10K RPM SFF (2.5-INCH) DUAL PORT ENTERPRISE
708	1	T7885	MCAFFEE WINDOWS AV CLIENT
509	1	TRN7343	SEVEN AND A HALF FOOT RACK
443	1	B1905	MCC 7500 ASTRO 25 SOFTWARE
443	13	B1933	MOTOROLA VOICE PROCESSOR MODULE

APC	QTY	NOMENCLATURE	DESCRIPTION
443	13	CA01642AA	ADD: MCC 7500 BASIC CONSOLE FUNCTIONALITY SOFTWARE LICENSE
443	13	CA01643AA	ADD: MCC 7500 / MCC 7100 TRUNKING OPERATION
443	13	CA00147AF	ADD: MCC 7500 SECURE OPERATION
443	13	CA00182AB	ADD: AES ALGORITHM
443	13	CA00245AA	ADD: ADP ALGORITHM
443	13	CA00140AA	ADD: AC LINE CORD, NORTH AMERICAN
443	26	B1912	MCC SERIES DESKTOP SPEAKER
443	26	B1913	MCC SERIES HEADSET JACK
708	13	DSTWIN6328A	PROVIDES ONE DUAL PEDAL FOOTSWITCH FOR USE WITH MOTOROLA MCC 7500 DISP
708	13	TT2538	Z420 LOW TIER WORKSTATION WINDOWS 7
877	13	T7449	WINDOWS SUPPLEMENTAL TRANS CONFIG
708	13	T7885	MCAFFEE WINDOWS AV CLIENT
229	13	DDN1245	DUAL IRR SW USB HASP WITH LICENSE (VERSION 45)
229	13	DDN1118	REPL BY DQSBAUDIGYRX - PCI EXPRESS SOUND BLASTER X-FI XTREME AUDIO
708	13	CDN6673	CREATIVE LABS INSPIRE A60
147	2	CLN1856	2620-24 ETHERNET SWITCH
147	2	SQM01SUM0205	GGM 8000 GATEWAY
147	2	CA01616AA	ADD: AC POWER
147	3	SQM01SUM0205	GGM 8000 GATEWAY
147	3	CA01616AA	ADD: AC POWER
147	3	CA02086AA	ADD: HIGH DENSITY ENH CONV GATEWAY
443	1	B1905	MCC 7500 ASTRO 25 SOFTWARE
443	1	B1933	MOTOROLA VOICE PROCESSOR MODULE
443	1	CA00288AB	ADD: MCC 7500 ARCHIVING INTERFACE SERVER SOFTWARE LICENSE
443	1	CA00147AF	ADD: MCC 7500 SECURE OPERATION
443	1	CA00182AB	ADD: AES ALGORITHM
443	1	CA00245AA	ADD: ADP ALGORITHM
443	1	CA00140AA	ADD: AC LINE CORD, NORTH AMERICAN
708	1	T7885	MCAFFEE WINDOWS AV CLIENT
708	1	TT2538	Z420 LOW TIER WORKSTATION WINDOWS 7
708	1	DS2702965	HP XW4/Z2/Z4 DEPTH ADJUSTABLE FIXED RAIL RACK KIT (WH340AA)
509	1	TRN7343	SEVEN AND A HALF FOOT RACK
443	1	B1905	MCC 7500 ASTRO 25 SOFTWARE
443	18	B1933	MOTOROLA VOICE PROCESSOR MODULE
443	18	CA01642AA	ADD: MCC 7500 BASIC CONSOLE FUNCTIONALITY SOFTWARE LICENSE



APC	QTY	NOMENCLATURE	DESCRIPTION
443	18	CA01643AA	ADD: MCC 7500 / MCC 7100 TRUNKING OPERATION
443	18	CA00147AF	ADD: MCC 7500 SECURE OPERATION
443	18	CA00182AB	ADD: AES ALGORITHM
443	18	CA00245AA	ADD: ADP ALGORITHM
443	18	CA00140AA	ADD: AC LINE CORD, NORTH AMERICAN
443	36	B1912	MCC SERIES DESKTOP SPEAKER
443	36	B1913	MCC SERIES HEADSET JACK
708	18	DSTWIN6328A	PROVIDES ONE DUAL PEDAL FOOTSWITCH FOR USE WITH MOTOROLA MCC 7500 DISP
708	18	TT2538	Z420 LOW TIER WORKSTATION WINDOWS 7
877	18	T7449	WINDOWS SUPPLEMENTAL TRANS CONFIG
708	18	T7885	MCAFFEE WINDOWS AV CLIENT
229	18	DDN1245	DUAL IRR SW USB HASP WITH LICENSE (VERSION 45)
229	18	DQSBAUDIGYRX	SOUND BLASTER AUDIGY RX SOUND CARD
708	18	CDN6673	CREATIVE LABS INSPIRE A60
147	2	CLN1856	2620-24 ETHERNET SWITCH
147	2	SQM01SUM0205	GGM 8000 GATEWAY
147	2	CA01616AA	ADD: AC POWER
147	3	SQM01SUM0205	GGM 8000 GATEWAY
147	3	CA01616AA	ADD: AC POWER
147	3	CA02086AA	ADD: HIGH DENSITY ENH CONV GATEWAY
509	1	TRN7343	SEVEN AND A HALF FOOT RACK
708	3	TT2538	Z420 LOW TIER WORKSTATION WINDOWS 7
443	3	B1934	MCC 7500 VOICE PROCESSOR MODULE FRU
443	3	CA00147AF	ADD: MCC 7500 SECURE OPERATION
443	3	CA00182AB	ADD: AES ALGORITHM
443	3	CA00245AA	ADD: ADP ALGORITHM
147	1	CLN1856	2620-24 ETHERNET SWITCH
147	2	SQM01SUM0205	GGM 8000 GATEWAY
147	2	CA01616AA	ADD: AC POWER
147	2	CA02086AA	ADD: HIGH DENSITY ENH CONV GATEWAY
112	1	T7140	G-SERIES SOFTWARE UPGRADE
595	6	CA02219BA	SITE RPTR SC SW UPGRD IV&D
112	1	T7140	G-SERIES SOFTWARE UPGRADE
595	15	CA01116AA	ADD: SITE REPEATER BR SW UPGRADE
469	23	FVN5968	SDM3000 ASTRO F/W FOR A7.13
382	1	F5567	SDM3000 BUILDER SOFTWARE FOR A7.11 AND MOSCAD NFM LEGACY PACKAGE FOR
382	1	F5568	GMC/GWS GUI AND SDM3000 CONFIG S/W & DOC FOR MOSCAD NFM A7.11

APC	QTY	NOMENCLATURE	DESCRIPTION
112	1	T7140	G-SERIES SOFTWARE UPGRADE
112	3	CA01246AA	ADD: MCC 7500 CONV SITE UPGRADE
112	1	T7038	GCP 8000 SITE CONTROLLER
112	1	CA00303AA	ADD: QTY (1) SITE CONTROLLER
595	1	CA02474AA	ADD:GEO-REDUN BACK-UP SC LIC
595	1	CA01194AA	ADD: IP BASED MULTISITE SITE CONTROLLER SOFTWARE
112	1	X153AW	ADD: RACK MOUNT HARDWARE
595	13	CA02206AA	SIMULCAST REMOTE SITE LICENSE IV&D
112	1	CA01400AA	ADD: POWER CABLE, DC
112	1	T7038	GCP 8000 SITE CONTROLLER
112	1	CA00303AA	ADD: QTY (1) SITE CONTROLLER
595	1	CA02474AA	ADD:GEO-REDUN BACK-UP SC LIC
595	1	CA01194AA	ADD: IP BASED MULTISITE SITE CONTROLLER SOFTWARE
112	1	X153AW	ADD: RACK MOUNT HARDWARE
595	13	CA02206AA	SIMULCAST REMOTE SITE LICENSE IV&D
112	1	CA01400AA	ADD: POWER CABLE, DC
906	1	DSTRAK91008EDC	PRIME/MASTER SITE REDUNDANT MODULAR FREQUENCY TIMING SYSTEM DC
906	2	DSTRAK91061	FOUR PORT DDM
906	1	DSTRAK92003DC	***REPLACED BY TRAK 93007DC*** DISTRIBUTION CHASSIS
351	50	L1700	FSJ1-50A CABLE: 1/4" SUPERFLEX POLY JKT PER FOOT
351	4	DDN9769	TRANSMISSION LINE,F1TNM-HC 1/4IN TY
147	1	CLN1859	2620-48 ETHERNET SWITCH
147	1	CLN1856	2620-24 ETHERNET SWITCH
147	1	SQM01SUM0205	GGM 8000 GATEWAY
147	1	CA01619AA	ADD: DC POWER
147	1	SQM01SUM0205	GGM 8000 GATEWAY
147	1	CA01619AA	ADD: DC POWER
509	1	TRN7343	SEVEN AND A HALF FOOT RACK
469	1	F4544	SITE MANAGER ADVANCED
469	1	VA00905	ADD:24/48 VDC PS TO SM
469	1	VA00872	ADD: SDM ASTRO RTU FW CURR ASTRO REL
112	1	T7321	GCM 8000 COMPARATOR
112	2	CA01183AA	ADD: GCM 8000 COMPARATOR
595	2	CA01185AA	ADD: IP BASED MULTISITE OPERATION
112	1	X153AW	ADD: RACK MOUNT HARDWARE
595	1	CA01974AA	TRUNKING REDUNDANT COMPRTTR SW



APC	QTY	NOMENCLATURE	DESCRIPTION
112	1	CA01400AA	ADD: POWER CABLE, DC
112	1	T7321	GCM 8000 COMPARATOR
112	2	CA01183AA	ADD: GCM 8000 COMPARATOR
595	2	CA01185AA	ADD: IP BASED MULTISITE OPERATION
112	1	X153AW	ADD: RACK MOUNT HARDWARE
595	1	CA01974AA	TRUNKING REDUNDANT COMPRTR SW
112	1	CA01400AA	ADD: POWER CABLE, DC
112	1	T7321	GCM 8000 COMPARATOR
112	2	CA01183AA	ADD: GCM 8000 COMPARATOR
595	2	CA01185AA	ADD: IP BASED MULTISITE OPERATION
112	1	X153AW	ADD: RACK MOUNT HARDWARE
595	1	CA01974AA	TRUNKING REDUNDANT COMPRTR SW
112	1	CA01400AA	ADD: POWER CABLE, DC
112	1	T7321	GCM 8000 COMPARATOR
112	2	CA01183AA	ADD: GCM 8000 COMPARATOR
595	2	CA01185AA	ADD: IP BASED MULTISITE OPERATION
112	1	X153AW	ADD: RACK MOUNT HARDWARE
595	1	CA01974AA	TRUNKING REDUNDANT COMPRTR SW
112	1	CA01400AA	ADD: POWER CABLE, DC
112	1	T7321	GCM 8000 COMPARATOR
112	2	CA01183AA	ADD: GCM 8000 COMPARATOR
595	2	CA01185AA	ADD: IP BASED MULTISITE OPERATION
112	1	X153AW	ADD: RACK MOUNT HARDWARE
595	1	CA01974AA	TRUNKING REDUNDANT COMPRTR SW
112	1	CA01400AA	ADD: POWER CABLE, DC
112	1	T7321	GCM 8000 COMPARATOR
112	2	CA01183AA	ADD: GCM 8000 COMPARATOR
595	2	CA01185AA	ADD: IP BASED MULTISITE OPERATION
112	1	X153AW	ADD: RACK MOUNT HARDWARE
595	1	CA01974AA	TRUNKING REDUNDANT COMPRTR SW
112	1	CA01400AA	ADD: POWER CABLE, DC
112	1	T7321	GCM 8000 COMPARATOR
112	2	CA01183AA	ADD: GCM 8000 COMPARATOR
595	2	CA01185AA	ADD: IP BASED MULTISITE OPERATION
112	1	X153AW	ADD: RACK MOUNT HARDWARE
595	1	CA01974AA	TRUNKING REDUNDANT COMPRTR SW
112	1	CA01400AA	ADD: POWER CABLE, DC
112	1	T7321	GCM 8000 COMPARATOR
112	2	CA01183AA	ADD: GCM 8000 COMPARATOR

APC	QTY	NOMENCLATURE	DESCRIPTION
595	2	CA01185AA	ADD: IP BASED MULTISITE OPERATION
112	1	X153AW	ADD: RACK MOUNT HARDWARE
595	1	CA01974AA	TRUNKING REDUNDANT COMPRTR SW
112	1	CA01400AA	ADD: POWER CABLE, DC
112	1	T7321	GCM 8000 COMPARATOR
112	2	CA01183AA	ADD: GCM 8000 COMPARATOR
595	2	CA01185AA	ADD: IP BASED MULTISITE OPERATION
112	1	X153AW	ADD: RACK MOUNT HARDWARE
595	1	CA01974AA	TRUNKING REDUNDANT COMPRTR SW
112	1	CA01400AA	ADD: POWER CABLE, DC
112	1	T7321	GCM 8000 COMPARATOR
112	2	CA01183AA	ADD: GCM 8000 COMPARATOR
595	2	CA01185AA	ADD: IP BASED MULTISITE OPERATION
112	1	X153AW	ADD: RACK MOUNT HARDWARE
595	1	CA01974AA	TRUNKING REDUNDANT COMPRTR SW
112	1	CA01400AA	ADD: POWER CABLE, DC
112	1	T7321	GCM 8000 COMPARATOR
112	2	CA01183AA	ADD: GCM 8000 COMPARATOR
595	2	CA01185AA	ADD: IP BASED MULTISITE OPERATION
112	1	X153AW	ADD: RACK MOUNT HARDWARE
595	1	CA01974AA	TRUNKING REDUNDANT COMPRTR SW
112	1	CA01400AA	ADD: POWER CABLE, DC
112	1	T7321	GCM 8000 COMPARATOR
112	2	CA01183AA	ADD: GCM 8000 COMPARATOR
595	2	CA01185AA	ADD: IP BASED MULTISITE OPERATION
112	1	X153AW	ADD: RACK MOUNT HARDWARE
595	1	CA01974AA	TRUNKING REDUNDANT COMPRTR SW
112	1	CA01400AA	ADD: POWER CABLE, DC
207	1	DS280700	DC SYSTEM FP2 -48/300 BD 19 2BT
207	4	DS241115105	RECTIFIER, FLATPACK 2 48/2000 HE
207	3	DS236408	BLIND PANEL FP2 HE BLACK G1
207	1	DS268132	INVERTER, 1 KVA, 48VDCIN/120VACOUT 2RU RM 19/23 IN NEWMAR 48-1000RM
207	1	DS502656	25 AMP CIRCUIT BREAKER
207	2	DS502877	48V 125AH 12V125F ENERSYS BATT SET
207	2	DS502653	BREAKER 10A 1P AUX 5/16 BULLET
207	18	DS502652	5 AMP CIRCUIT BREAKER
207	2	DS230700	KIT: BATTERY MONITOR 10M G1, BATTERY MONITOR CAN BUS NODE
112	1	T7038	GCP 8000 SITE CONTROLLER



APC	QTY	NOMENCLATURE	DESCRIPTION
112	1	CA00303AA	ADD: QTY (1) SITE CONTROLLER
595	1	CA02474AA	ADD:GEO-REDUN BACK-UP SC LIC
595	1	CA01194AA	ADD: IP BASED MULTISITE SITE CONTROLLER SOFTWARE
112	1	X153AW	ADD: RACK MOUNT HARDWARE
112	1	CA01400AA	ADD: POWER CABLE, DC
147	1	SQM01SUM0205	GGM 8000 GATEWAY
147	1	CA01619AA	ADD: DC POWER
147	1	CLN1856	2620-24 ETHERNET SWITCH
147	1	CLN1859	2620-48 ETHERNET SWITCH
147	1	SQM01SUM0205	GGM 8000 GATEWAY
147	1	CA01619AA	ADD: DC POWER
509	1	TRN7343	SEVEN AND A HALF FOOT RACK
469	1	F4544	SITE MANAGER ADVANCED
469	1	VA00905	ADD:24/48 VDC PS TO SM
469	1	VA00872	ADD: SDM ASTRO RTU FW CURR ASTRO REL
112	1	T7321	GCM 8000 COMPARATOR
112	2	CA01183AA	ADD: GCM 8000 COMPARATOR
595	2	CA01185AA	ADD: IP BASED MULTISITE OPERATION
112	1	X153AW	ADD: RACK MOUNT HARDWARE
595	1	CA01974AA	TRUNKING REDUNDANT COMPRTR SW
112	1	CA01400AA	ADD: POWER CABLE, DC
112	1	T7321	GCM 8000 COMPARATOR
112	2	CA01183AA	ADD: GCM 8000 COMPARATOR
595	2	CA01185AA	ADD: IP BASED MULTISITE OPERATION
112	1	X153AW	ADD: RACK MOUNT HARDWARE
595	1	CA01974AA	TRUNKING REDUNDANT COMPRTR SW
112	1	CA01400AA	ADD: POWER CABLE, DC
112	1	T7321	GCM 8000 COMPARATOR
112	2	CA01183AA	ADD: GCM 8000 COMPARATOR
595	2	CA01185AA	ADD: IP BASED MULTISITE OPERATION
112	1	X153AW	ADD: RACK MOUNT HARDWARE
595	1	CA01974AA	TRUNKING REDUNDANT COMPRTR SW
112	1	CA01400AA	ADD: POWER CABLE, DC
112	1	T7321	GCM 8000 COMPARATOR
112	2	CA01183AA	ADD: GCM 8000 COMPARATOR
595	2	CA01185AA	ADD: IP BASED MULTISITE OPERATION
112	1	X153AW	ADD: RACK MOUNT HARDWARE
595	1	CA01974AA	TRUNKING REDUNDANT COMPRTR SW

APC	QTY	NOMENCLATURE	DESCRIPTION
112	1	CA01400AA	ADD: POWER CABLE, DC
112	1	T7321	GCM 8000 COMPARATOR
112	2	CA01183AA	ADD: GCM 8000 COMPARATOR
595	2	CA01185AA	ADD: IP BASED MULTISITE OPERATION
112	1	X153AW	ADD: RACK MOUNT HARDWARE
595	1	CA01974AA	TRUNKING REDUNDANT COMPRTR SW
112	1	CA01400AA	ADD: POWER CABLE, DC
112	1	T7321	GCM 8000 COMPARATOR
112	2	CA01183AA	ADD: GCM 8000 COMPARATOR
595	2	CA01185AA	ADD: IP BASED MULTISITE OPERATION
112	1	X153AW	ADD: RACK MOUNT HARDWARE
595	1	CA01974AA	TRUNKING REDUNDANT COMPRTR SW
112	1	CA01400AA	ADD: POWER CABLE, DC
112	1	T7321	GCM 8000 COMPARATOR
112	2	CA01183AA	ADD: GCM 8000 COMPARATOR
595	2	CA01185AA	ADD: IP BASED MULTISITE OPERATION
112	1	X153AW	ADD: RACK MOUNT HARDWARE
595	1	CA01974AA	TRUNKING REDUNDANT COMPRTR SW
112	1	CA01400AA	ADD: POWER CABLE, DC
112	1	T7321	GCM 8000 COMPARATOR
112	2	CA01183AA	ADD: GCM 8000 COMPARATOR
595	2	CA01185AA	ADD: IP BASED MULTISITE OPERATION
112	1	X153AW	ADD: RACK MOUNT HARDWARE
595	1	CA01974AA	TRUNKING REDUNDANT COMPRTR SW
112	1	CA01400AA	ADD: POWER CABLE, DC
112	1	T7321	GCM 8000 COMPARATOR
112	2	CA01183AA	ADD: GCM 8000 COMPARATOR
595	2	CA01185AA	ADD: IP BASED MULTISITE OPERATION
112	1	X153AW	ADD: RACK MOUNT HARDWARE
595	1	CA01974AA	TRUNKING REDUNDANT COMPRTR SW
112	1	CA01400AA	ADD: POWER CABLE, DC
112	1	T7321	GCM 8000 COMPARATOR
112	2	CA01183AA	ADD: GCM 8000 COMPARATOR
595	2	CA01185AA	ADD: IP BASED MULTISITE OPERATION
112	1	X153AW	ADD: RACK MOUNT HARDWARE
595	1	CA01974AA	TRUNKING REDUNDANT COMPRTR SW
112	1	CA01400AA	ADD: POWER CABLE, DC
112	1	T7321	GCM 8000 COMPARATOR
112	2	CA01183AA	ADD: GCM 8000 COMPARATOR



APC	QTY	NOMENCLATURE	DESCRIPTION
595	2	CA01185AA	ADD: IP BASED MULTISITE OPERATION
112	1	X153AW	ADD: RACK MOUNT HARDWARE
595	1	CA01974AA	TRUNKING REDUNDANT COMPRTR SW
112	1	CA01400AA	ADD: POWER CABLE, DC
112	1	T7321	GCM 8000 COMPARATOR
112	2	CA01183AA	ADD: GCM 8000 COMPARATOR
595	2	CA01185AA	ADD: IP BASED MULTISITE OPERATION
112	1	X153AW	ADD: RACK MOUNT HARDWARE
595	1	CA01974AA	TRUNKING REDUNDANT COMPRTR SW
112	1	CA01400AA	ADD: POWER CABLE, DC
207	1	DS280700	DC SYSTEM FP2 -48/300 BD 19 2BT
207	4	DS241115105	RECTIFIER, FLATPACK 2 48/2000 HE
207	3	DS236408	BLIND PANEL FP2 HE BLACK G1
207	1	DS268132	INVERTER, 1 KVA, 48VDCIN/120VACOUT 2RU RM 19/23 IN NEWMAR 48-1000RM
207	1	DS502656	25 AMP CIRCUIT BREAKER
207	2	DS502877	48V 125AH 12V125F ENERSYS BATT SET
207	2	DS502653	BREAKER 10A 1P AUX 5/16 BULLET
207	18	DS502652	5 AMP CIRCUIT BREAKER
207	2	DS230700	KIT: BATTERY MONITOR 10M G1, BATTERY MONITOR CAN BUS NODE
351	1	DSWIJD86204S	COMB WAV-G 851-869 4CH 7/16 ANT, 150 KHZ MIN SEP BETWEEN CHANNELS
351	8	DDN9682	F4PNMV2-HC 1/2" TYPE N MALE PLATED CONNECTOR
351	100	L1702	FSJ4-50B CABLE: 1/2" SUPERFLEX POLY JKT PER FOOT
906	1	DSTRAK9100MFDC	9100 MAIN FRAME 3U CHASSIS DC POWER
906	3	DSTRAK91211	DC INPUT POWER SUPPLY MODULE
906	1	DSTRAK91061	FOUR PORT DDM
147	2	SQM01SUM0205	GGM 8000 GATEWAY
147	2	CA01619AA	ADD: DC POWER
147	2	CLN1859	2620-48 ETHERNET SWITCH
112	2	DLN6569	FRU: GCP 8000/GCM 8000
112	1	DLN6781	FRU POWER SUPPLY
729	1	DLN6455	CONFIGURATION/SERVICE SOFTWARE
112	1	DLN6898	FRU: FAN MODULE
112	1	DLN6821	FRU: GTR ANALOG 4W E&M SIMULCST KIT
112	1	DLN6709	GTR/GPW OPTION CARD
147	26	SQM01SUM0205	GGM 8000 GATEWAY
147	2	CA01619AA	ADD: DC POWER
147	26	CLN1856	2620-24 ETHERNET SWITCH

APC	QTY	NOMENCLATURE	DESCRIPTION
112	297	T7140	G-SERIES SOFTWARE UPGRADE
595	297	CA01195AA	ADD: IP BASED MULTISITE BASE RADIO SOFTWARE UPGRADE
	297	(M) CA0XXXXAA	(M) ADD: CIRCUIT BASED MULTISITE BR
112	15	T7039	GTR 8000 Base Radio
112	15	CA00855AA	ADD: 700/800 MHZ
595	15	CA01193AA	ADD: IP BASED MULTISITE BASE RADIO SOFTWARE
112	15	X153AW	ADD: RACK MOUNT HARDWARE
112	15	CA01400AA	ADD: POWER CABLE, DC
	1	SOFTWARE CREDIT	SOFTWARE CREDIT
131	1	(M) DQMWLOUVILB2R F	Includes items 1.100-1.406, 1.600-1.603 & 6.101
131	1	(M) DQMWLOUVILB2S P	Includes items 1.500-1.511
131	1	(M) DQMWLOUVILB2N M	Includes items 2.100-2.104
131	1	(M) DQMWLOUVILB2A D	Includes items 3.100-3.403
131	1	(M) DQMWLOUVILB2C G	Includes items 4.100-4.103
131	1	(M) DQMWLOUVILB2B T	Includes item 4.201
147	2	CLN1856	2620-24 ETHERNET SWITCH
147	2	SQM01SUM0205	GGM 8000 GATEWAY
147	2	CA01616AA	ADD: AC POWER
469	1	F4543	SITE MANAGER BASIC
469	1	VA00874	ADD: AUX I-O SERV FW CURR ASTRO REL
469	1	V266	ADD: 90VAC TO 260VAC PS TO SM
469	3	V592	AAD TERM BLCK & CONN WI
112	1	T7038	GCP 8000 SITE CONTROLLER
112	1	CA00303AA	ADD: QTY (1) SITE CONTROLLER
112	1	X153AW	ADD: RACK MOUNT HARDWARE
595	1	CA01136AA	ADD: MCC 7500 CONVEN SITE OPER
147	1	SQM01SUM0205	GGM 8000 GATEWAY
147	1	CA01616AA	ADD: AC POWER
147	1	CA02086AA	ADD: HIGH DENSITY ENH CONV GATEWAY



APC	QTY	NOMENCLATURE	DESCRIPTION
443	1	B1940	MCC 7100 DVD
443	20	B1939	MCC 7100 IP Dispatch Position Main Model
443	20	CA01642AB	ADD: MCC 7100 BASIC CONSOLE FUNCTIONALITY SOFTWARE LICENSE
443	20	CA01643AA	ADD: MCC 7500 / MCC 7100 TRUNKING OPERATION
443	20	CA02180AA	ADD: MCC 7100 SECURE OPERATION
443	20	HKVN4159A	10 CHANNEL SW LICENSE
877	20	T7449	WINDOWS SUPPLEMENTAL TRANS CONFIG
229	20	DDN1391	MUSIK USB SPEAKERS (SET OF 2) PALO ALTO
443	20	B1941	USB AUDIO INTERFACE MODULE
443	20	B1913	MCC SERIES HEADSET JACK
708	20	DSTWIN6328A	PROVIDES ONE DUAL PEDAL FOOTSWITCH FOR USE WITH MOTOROLA MCC 7500 DISP
708	20	T7885	MCAFEE WINDOWS AV CLIENT
443	20	HKVN4225A	MCC 7100 INSTANT RECALL RECORDER LICENSE
112	3	F2979	MLC 8000
112	3	VA00783AA	ADD: ANALOG CONVENTIONAL SIMULCAST COMPARATOR/GATEWAY
112	3	VA00012AA	ADD: 120/240VAC TO +12VDC POWER ADAPTER
112	3	VA00011AA	19INCH RACK MOUNT HARDWARE KIT CABINET OR RACK
147	1	CLN1856	2620-24 ETHERNET SWITCH
147	1	SQM01SUM0205	GGM 8000 GATEWAY
147	1	CA01616AA	ADD: AC POWER
112	3	F2979	MLC 8000
112	3	VA00783AA	ADD: ANALOG CONVENTIONAL SIMULCAST COMPARATOR/GATEWAY
112	3	VA00012AA	ADD: 120/240VAC TO +12VDC POWER ADAPTER
112	3	VA00011AA	19INCH RACK MOUNT HARDWARE KIT CABINET OR RACK
112	1	T7039	GTR 8000 Base Radio
112	1	CA00855AA	ADD: 700/800 MHZ
595	1	CA01949AA	ADD: ANALOG ONLY CONV SW
595	1	CA01952AA	ADD: ANALOG CONVENTIONAL SIMULCAST SOFTWARE
112	1	X265AH	ADD: BR PRESELECTOR, 800 MHZ
112	1	X153AW	ADD: RACK MOUNT HARDWARE
112	1	T7039	GTR 8000 Base Radio
112	1	CA00855AA	ADD: 700/800 MHZ
595	1	CA01949AA	ADD: ANALOG ONLY CONV SW
595	1	CA01952AA	ADD: ANALOG CONVENTIONAL SIMULCAST SOFTWARE
112	1	X265AH	ADD: BR PRESELECTOR, 800 MHZ

APC	QTY	NOMENCLATURE	DESCRIPTION
112	1	X153AW	ADD: RACK MOUNT HARDWARE
112	1	T7039	GTR 8000 Base Radio
112	1	CA00855AA	ADD: 700/800 MHZ
595	1	CA01949AA	ADD: ANALOG ONLY CONV SW
595	1	CA01952AA	ADD: ANALOG CONVENTIONAL SIMULCAST SOFTWARE
112	1	X265AH	ADD: BR PRESELECTOR, 800 MHZ
112	1	X153AW	ADD: RACK MOUNT HARDWARE
906	3	DSTRAK91061	FOUR PORT DDM
207	2	DSRMP615A	SPD, TYPE 3, 120V RACK MOUNT, 15A PLUG-IN W/ (6) 15A NEMA 5-15 OUTLETS
207	1	DS46353505	CHATSWORTH 19 INCH EQUIPMENT RACK 7.5 FT
147	1	SQM01SUM0205	GGM 8000 GATEWAY
147	1	CA01616AA	ADD: AC POWER
147	1	CA02141AA	ADD: LOW DENSITY ENH CONV GATEWAY
147	1	CLN1856	2620-24 ETHERNET SWITCH
147	1	SQM01SUM0205	GGM 8000 GATEWAY
147	1	CA01619AA	ADD: DC POWER
112	3	F2979	MLC 8000
112	3	VA00783AA	ADD: ANALOG CONVENTIONAL SIMULCAST COMPARATOR/GATEWAY
112	3	VA00012AA	ADD: 120/240VAC TO +12VDC POWER ADAPTER
112	3	VA00011AA	19INCH RACK MOUNT HARDWARE KIT CABINET OR RACK
112	1	T7039	GTR 8000 Base Radio
112	1	CA00855AA	ADD: 700/800 MHZ
595	1	CA01949AA	ADD: ANALOG ONLY CONV SW
595	1	CA01952AA	ADD: ANALOG CONVENTIONAL SIMULCAST SOFTWARE
112	1	X265AH	ADD: BR PRESELECTOR, 800 MHZ
112	1	CA01400AA	ADD: POWER CABLE, DC
112	1	X153AW	ADD: RACK MOUNT HARDWARE
112	1	T7039	GTR 8000 Base Radio
112	1	CA00855AA	ADD: 700/800 MHZ
595	1	CA01949AA	ADD: ANALOG ONLY CONV SW
595	1	CA01952AA	ADD: ANALOG CONVENTIONAL SIMULCAST SOFTWARE
112	1	X265AH	ADD: BR PRESELECTOR, 800 MHZ
112	1	CA01400AA	ADD: POWER CABLE, DC
112	1	X153AW	ADD: RACK MOUNT HARDWARE
112	1	T7039	GTR 8000 Base Radio
112	1	CA00855AA	ADD: 700/800 MHZ
595	1	CA01949AA	ADD: ANALOG ONLY CONV SW



APC	QTY	NOMENCLATURE	DESCRIPTION
595	1	CA01952AA	ADD: ANALOG CONVENTIONAL SIMULCAST SOFTWARE
112	1	X265AH	ADD: BR PRESELECTOR, 800 MHZ
112	1	CA01400AA	ADD: POWER CABLE, DC
112	1	X153AW	ADD: RACK MOUNT HARDWARE
906	2	DSTRAK91061	FOUR PORT DDM
228	1	BLN6200	AC POWER STRIP, 6 OUTLET
207	1	DS268132	INVERTER, 1 KVA, 48VDCIN/120VACOUT 2RU RM 19/23 IN NEWMAR 48-1000RM
207	1	DS502653	BREAKER 10A 1P AUX 5/16 BULLET
207	3	DS502656	25 AMP CIRCUIT BREAKER
207	1	DS46353505	CHATSWORTH 19 INCH EQUIPMENT RACK 7.5 FT
147	1	CLN1856	2620-24 ETHERNET SWITCH
147	1	SQM01SUM0205	GGM 8000 GATEWAY
147	1	CA01619AA	ADD: DC POWER
112	3	F2979	MLC 8000
112	3	VA00783AA	ADD: ANALOG CONVENTIONAL SIMULCAST COMPARATOR/GATEWAY
112	3	VA00012AA	ADD: 120/240VAC TO +12VDC POWER ADAPTER
112	3	VA00011AA	19INCH RACK MOUNT HARDWARE KIT CABINET OR RACK
112	1	T7039	GTR 8000 Base Radio
112	1	CA00855AA	ADD: 700/800 MHZ
595	1	CA01949AA	ADD: ANALOG ONLY CONV SW
595	1	CA01952AA	ADD: ANALOG CONVENTIONAL SIMULCAST SOFTWARE
112	1	X265AH	ADD: BR PRESELECTOR, 800 MHZ
112	1	CA01400AA	ADD: POWER CABLE, DC
112	1	X153AW	ADD: RACK MOUNT HARDWARE
112	1	T7039	GTR 8000 Base Radio
112	1	CA00855AA	ADD: 700/800 MHZ
595	1	CA01949AA	ADD: ANALOG ONLY CONV SW
595	1	CA01952AA	ADD: ANALOG CONVENTIONAL SIMULCAST SOFTWARE
112	1	X265AH	ADD: BR PRESELECTOR, 800 MHZ
112	1	CA01400AA	ADD: POWER CABLE, DC
112	1	X153AW	ADD: RACK MOUNT HARDWARE
112	1	T7039	GTR 8000 Base Radio
112	1	CA00855AA	ADD: 700/800 MHZ
595	1	CA01949AA	ADD: ANALOG ONLY CONV SW
595	1	CA01952AA	ADD: ANALOG CONVENTIONAL SIMULCAST SOFTWARE
112	1	X265AH	ADD: BR PRESELECTOR, 800 MHZ
112	1	CA01400AA	ADD: POWER CABLE, DC

APC	QTY	NOMENCLATURE	DESCRIPTION
112	1	X153AW	ADD: RACK MOUNT HARDWARE
906	2	DSTRAK91061	FOUR PORT DDM
228	1	BLN6200	AC POWER STRIP, 6 OUTLET
207	1	DS268132	INVERTER, 1 KVA, 48VDCIN/120VACOUT 2RU RM 19/23 IN NEWMAR 48-1000RM
207	1	DS502653	BREAKER 10A 1P AUX 5/16 BULLET
207	3	DS502656	25 AMP CIRCUIT BREAKER
207	1	DS46353505	CHATSWORTH 19 INCH EQUIPMENT RACK 7.5 FT
147	1	CLN1856	2620-24 ETHERNET SWITCH
147	1	SQM01SUM0205	GGM 8000 GATEWAY
147	1	CA01619AA	ADD: DC POWER
112	3	F2979	MLC 8000
112	3	VA00783AA	ADD: ANALOG CONVENTIONAL SIMULCAST COMPARATOR/GATEWAY
112	3	VA00012AA	ADD: 120/240VAC TO +12VDC POWER ADAPTER
112	3	VA00011AA	19INCH RACK MOUNT HARDWARE KIT CABINET OR RACK
112	1	T7039	GTR 8000 Base Radio
112	1	CA00855AA	ADD: 700/800 MHZ
595	1	CA01949AA	ADD: ANALOG ONLY CONV SW
595	1	CA01952AA	ADD: ANALOG CONVENTIONAL SIMULCAST SOFTWARE
112	1	X265AH	ADD: BR PRESELECTOR, 800 MHZ
112	1	CA01400AA	ADD: POWER CABLE, DC
112	1	X153AW	ADD: RACK MOUNT HARDWARE
112	1	T7039	GTR 8000 Base Radio
112	1	CA00855AA	ADD: 700/800 MHZ
595	1	CA01949AA	ADD: ANALOG ONLY CONV SW
595	1	CA01952AA	ADD: ANALOG CONVENTIONAL SIMULCAST SOFTWARE
112	1	X265AH	ADD: BR PRESELECTOR, 800 MHZ
112	1	CA01400AA	ADD: POWER CABLE, DC
112	1	X153AW	ADD: RACK MOUNT HARDWARE
112	1	T7039	GTR 8000 Base Radio
112	1	CA00855AA	ADD: 700/800 MHZ
595	1	CA01949AA	ADD: ANALOG ONLY CONV SW
595	1	CA01952AA	ADD: ANALOG CONVENTIONAL SIMULCAST SOFTWARE
112	1	X265AH	ADD: BR PRESELECTOR, 800 MHZ
112	1	CA01400AA	ADD: POWER CABLE, DC
112	1	X153AW	ADD: RACK MOUNT HARDWARE
906	2	DSTRAK91061	FOUR PORT DDM
228	1	BLN6200	AC POWER STRIP, 6 OUTLET



APC	QTY	NOMENCLATURE	DESCRIPTION
207	1	DS268132	INVERTER, 1 KVA, 48VDCIN/120VACOUT 2RU RM 19/23 IN NEWMAR 48-1000RM
207	1	DS502653	BREAKER 10A 1P AUX 5/16 BULLET
207	3	DS502656	25 AMP CIRCUIT BREAKER
207	1	DS46353505	CHATSWORTH 19 INCH EQUIPMENT RACK 7.5 FT
147	1	CLN1856	2620-24 ETHERNET SWITCH
147	1	SQM01SUM0205	GGM 8000 GATEWAY
147	1	CA01619AA	ADD: DC POWER
112	3	F2979	MLC 8000
112	3	VA00783AA	ADD: ANALOG CONVENTIONAL SIMULCAST COMPARATOR/GATEWAY
112	3	VA00012AA	ADD: 120/240VAC TO +12VDC POWER ADAPTER
112	3	VA00011AA	19INCH RACK MOUNT HARDWARE KIT CABINET OR RACK
112	1	T7039	GTR 8000 Base Radio
112	1	CA00855AA	ADD: 700/800 MHZ
595	1	CA01949AA	ADD: ANALOG ONLY CONV SW
595	1	CA01952AA	ADD: ANALOG CONVENTIONAL SIMULCAST SOFTWARE
112	1	X265AH	ADD: BR PRESELECTOR, 800 MHZ
112	1	CA01400AA	ADD: POWER CABLE, DC
112	1	X153AW	ADD: RACK MOUNT HARDWARE
112	1	T7039	GTR 8000 Base Radio
112	1	CA00855AA	ADD: 700/800 MHZ
595	1	CA01949AA	ADD: ANALOG ONLY CONV SW
595	1	CA01952AA	ADD: ANALOG CONVENTIONAL SIMULCAST SOFTWARE
112	1	X265AH	ADD: BR PRESELECTOR, 800 MHZ
112	1	CA01400AA	ADD: POWER CABLE, DC
112	1	X153AW	ADD: RACK MOUNT HARDWARE
112	1	T7039	GTR 8000 Base Radio
112	1	CA00855AA	ADD: 700/800 MHZ
595	1	CA01949AA	ADD: ANALOG ONLY CONV SW
595	1	CA01952AA	ADD: ANALOG CONVENTIONAL SIMULCAST SOFTWARE
112	1	X265AH	ADD: BR PRESELECTOR, 800 MHZ
112	1	CA01400AA	ADD: POWER CABLE, DC
112	1	X153AW	ADD: RACK MOUNT HARDWARE
906	2	DSTRAK91061	FOUR PORT DDM
228	1	BLN6200	AC POWER STRIP, 6 OUTLET
207	1	DS268132	INVERTER, 1 KVA, 48VDCIN/120VACOUT 2RU RM 19/23 IN NEWMAR 48-1000RM
207	1	DS502653	BREAKER 10A 1P AUX 5/16 BULLET

APC	QTY	NOMENCLATURE	DESCRIPTION
207	3	DS502656	25 AMP CIRCUIT BREAKER
207	1	DS46353505	CHATSWORTH 19 INCH EQUIPMENT RACK 7.5 FT
112	1	F2979	MLC 8000
112	1	VA00783AA	ADD: ANALOG CONVENTIONAL SIMULCAST COMPARATOR/GATEWAY
112	1	VA00012AA	ADD: 120/240VAC TO +12VDC POWER ADAPTER
112	1	VA00011AA	19INCH RACK MOUNT HARDWARE KIT CABINET OR RACK
147	1	CLN1856	2620-24 ETHERNET SWITCH
147	1	SQM01SUM0205	GGM 8000 GATEWAY
147	1	CA01616AA	ADD: AC POWER
112	1	F2979	MLC 8000
112	1	VA00783AA	ADD: ANALOG CONVENTIONAL SIMULCAST COMPARATOR/GATEWAY
112	1	VA00012AA	ADD: 120/240VAC TO +12VDC POWER ADAPTER
112	1	VA00011AA	19INCH RACK MOUNT HARDWARE KIT CABINET OR RACK
112	1	T7039	GTR 8000 Base Radio
112	1	X530BG	ADD: VHF (136-174 MHZ)
595	1	CA01949AA	ADD: ANALOG ONLY CONV SW
595	1	CA01952AA	ADD: ANALOG CONVENTIONAL SIMULCAST SOFTWARE
112	1	X265AM	BR PRESELCOR, 150-174 MHZ
112	1	X153AW	ADD: RACK MOUNT HARDWARE
112	1	CA01504AA	ADD: ANTENNA RELAY
457	1	DSPA32GGHMS	POWER AMPLIFIER, PA3-2GG-HMS VHF HIGH BAND,PIN=60-100W, POUT=500W
906	2	DSTRAK91061	FOUR PORT DDM
207	1	DSRMP615A	SPD, TYPE 3, 120V RACK MOUNT, 15A PLUG-IN W/ (6) 15A NEMA 5-15 OUTLETS
147	1	SQM01SUM0205	GGM 8000 GATEWAY
147	1	CA01616AA	ADD: AC POWER
147	1	CA02141AA	ADD: LOW DENSITY ENH CONV GATEWAY
207	1	DS46353505	CHATSWORTH 19 INCH EQUIPMENT RACK 7.5 FT
147	1	CLN1856	2620-24 ETHERNET SWITCH
147	1	SQM01SUM0205	GGM 8000 GATEWAY
147	1	CA01619AA	ADD: DC POWER
112	1	F2979	MLC 8000
112	1	VA00783AA	ADD: ANALOG CONVENTIONAL SIMULCAST COMPARATOR/GATEWAY
112	1	VA00012AA	ADD: 120/240VAC TO +12VDC POWER ADAPTER



APC	QTY	NOMENCLATURE	DESCRIPTION
112	1	VA00011AA	19INCH RACK MOUNT HARDWARE KIT CABINET OR RACK
112	1	T7039	GTR 8000 Base Radio
112	1	X530BG	ADD: VHF (136-174 MHZ)
595	1	CA01949AA	ADD: ANALOG ONLY CONV SW
595	1	CA01952AA	ADD: ANALOG CONVENTIONAL SIMULCAST SOFTWARE
112	1	X265AM	BR PRESELCTOR, 150-174 MHZ
112	1	X153AW	ADD: RACK MOUNT HARDWARE
112	1	CA01504AA	ADD: ANTENNA RELAY
112	1	CA01400AA	ADD: POWER CABLE, DC
457	1	DSPA32GGHMS	POWER AMPLIFIER, PA3-2GG-HMS VHF HIGH BAND,PIN=60-100W, POUT=500W
906	2	DSTRAK91061	FOUR PORT DDM
228	1	BLN6200	AC POWER STRIP, 6 OUTLET
207	1	DS268132	INVERTER, 1 KVA, 48VDCIN/120VACOUT 2RU RM 19/23 IN NEWMAR 48-1000RM
207	1	DS502653	BREAKER 10A 1P AUX 5/16 BULLET
207	1	DS502656	25 AMP CIRCUIT BREAKER
207	1	DS46353505	CHATSWORTH 19 INCH EQUIPMENT RACK 7.5 FT
147	1	CLN1856	2620-24 ETHERNET SWITCH
147	1	SQM01SUM0205	GGM 8000 GATEWAY
147	1	CA01619AA	ADD: DC POWER
112	1	F2979	MLC 8000
112	1	VA00783AA	ADD: ANALOG CONVENTIONAL SIMULCAST COMPARATOR/GATEWAY
112	1	VA00012AA	ADD: 120/240VAC TO +12VDC POWER ADAPTER
112	1	VA00011AA	19INCH RACK MOUNT HARDWARE KIT CABINET OR RACK
112	1	T7039	GTR 8000 Base Radio
112	1	X530BG	ADD: VHF (136-174 MHZ)
595	1	CA01949AA	ADD: ANALOG ONLY CONV SW
595	1	CA01952AA	ADD: ANALOG CONVENTIONAL SIMULCAST SOFTWARE
112	1	X265AM	BR PRESELCTOR, 150-174 MHZ
112	1	X153AW	ADD: RACK MOUNT HARDWARE
112	1	CA01504AA	ADD: ANTENNA RELAY
112	1	CA01400AA	ADD: POWER CABLE, DC
457	1	DSPA32GGHMS	POWER AMPLIFIER, PA3-2GG-HMS VHF HIGH BAND,PIN=60-100W, POUT=500W
906	2	DSTRAK91061	FOUR PORT DDM
228	1	BLN6200	AC POWER STRIP, 6 OUTLET

APC	QTY	NOMENCLATURE	DESCRIPTION
207	1	DS268132	INVERTER, 1 KVA, 48VDCIN/120VACOUT 2RU RM 19/23 IN NEWMAR 48-1000RM
207	1	DS502653	BREAKER 10A 1P AUX 5/16 BULLET
207	1	DS502656	25 AMP CIRCUIT BREAKER
207	1	DS46353505	CHATSWORTH 19 INCH EQUIPMENT RACK 7.5 FT
147	1	CLN1856	2620-24 ETHERNET SWITCH
147	1	SQM01SUM0205	GGM 8000 GATEWAY
147	1	CA01619AA	ADD: DC POWER
112	1	F2979	MLC 8000
112	1	VA00783AA	ADD: ANALOG CONVENTIONAL SIMULCAST COMPARATOR/GATEWAY
112	1	VA00012AA	ADD: 120/240VAC TO +12VDC POWER ADAPTER
112	1	VA00011AA	19INCH RACK MOUNT HARDWARE KIT CABINET OR RACK
112	1	T7039	GTR 8000 Base Radio
112	1	X530BG	ADD: VHF (136-174 MHZ)
595	1	CA01949AA	ADD: ANALOG ONLY CONV SW
595	1	CA01952AA	ADD: ANALOG CONVENTIONAL SIMULCAST SOFTWARE
112	1	X265AM	BR PRESELCTOR, 150-174 MHZ
112	1	X153AW	ADD: RACK MOUNT HARDWARE
112	1	CA01504AA	ADD: ANTENNA RELAY
112	1	CA01400AA	ADD: POWER CABLE, DC
457	1	DSPA32GGHMS	POWER AMPLIFIER, PA3-2GG-HMS VHF HIGH BAND,PIN=60-100W, POUT=500W
906	2	DSTRAK91061	FOUR PORT DDM
228	1	BLN6200	AC POWER STRIP, 6 OUTLET
207	1	DS268132	INVERTER, 1 KVA, 48VDCIN/120VACOUT 2RU RM 19/23 IN NEWMAR 48-1000RM
207	1	DS502653	BREAKER 10A 1P AUX 5/16 BULLET
207	1	DS502656	25 AMP CIRCUIT BREAKER
207	1	DS46353505	CHATSWORTH 19 INCH EQUIPMENT RACK 7.5 FT
147	1	CLN1856	2620-24 ETHERNET SWITCH
147	1	SQM01SUM0205	GGM 8000 GATEWAY
147	1	CA01619AA	ADD: DC POWER
112	1	F2979	MLC 8000
112	1	VA00783AA	ADD: ANALOG CONVENTIONAL SIMULCAST COMPARATOR/GATEWAY
112	1	VA00012AA	ADD: 120/240VAC TO +12VDC POWER ADAPTER
112	1	VA00011AA	19INCH RACK MOUNT HARDWARE KIT CABINET OR RACK
112	1	T7039	GTR 8000 Base Radio

APC	QTY	NOMENCLATURE	DESCRIPTION
112	1	X530BG	ADD: VHF (136-174 MHZ)
595	1	CA01949AA	ADD: ANALOG ONLY CONV SW
595	1	CA01952AA	ADD: ANALOG CONVENTIONAL SIMULCAST SOFTWARE
112	1	X265AM	BR PRESELCTOR, 150-174 MHZ
112	1	X153AW	ADD: RACK MOUNT HARDWARE
112	1	CA01504AA	ADD: ANTENNA RELAY
112	1	CA01400AA	ADD: POWER CABLE, DC
457	1	DSPA32GGHMS	POWER AMPLIFIER, PA3-2GG-HMS VHF HIGH BAND,PIN=60-100W, POUT=500W
906	2	DSTRAK91061	FOUR PORT DDM
228	1	BLN6200	AC POWER STRIP, 6 OUTLET
207	1	DS268132	INVERTER, 1 KVA, 48VDCIN/120VACOUT 2RU RM 19/23 IN NEWMAR 48-1000RM
207	1	DS502653	BREAKER 10A 1P AUX 5/16 BULLET
207	1	DS502656	25 AMP CIRCUIT BREAKER
207	1	DS46353505	CHATSWORTH 19 INCH EQUIPMENT RACK 7.5 FT
147	1	CLN1856	2620-24 ETHERNET SWITCH
147	1	SQM01SUM0205	GGM 8000 GATEWAY
147	1	CA01619AA	ADD: DC POWER
112	1	F2979	MLC 8000
112	1	VA00783AA	ADD: ANALOG CONVENTIONAL SIMULCAST COMPARATOR/GATEWAY
112	1	VA00012AA	ADD: 120/240VAC TO +12VDC POWER ADAPTER
112	1	VA00011AA	19INCH RACK MOUNT HARDWARE KIT CABINET OR RACK
112	1	T7039	GTR 8000 Base Radio
112	1	X530BG	ADD: VHF (136-174 MHZ)
595	1	CA01949AA	ADD: ANALOG ONLY CONV SW
595	1	CA01952AA	ADD: ANALOG CONVENTIONAL SIMULCAST SOFTWARE
112	1	X265AM	BR PRESELCTOR, 150-174 MHZ
112	1	X153AW	ADD: RACK MOUNT HARDWARE
112	1	CA01504AA	ADD: ANTENNA RELAY
112	1	CA01400AA	ADD: POWER CABLE, DC
457	1	DSPA32GGHMS	POWER AMPLIFIER, PA3-2GG-HMS VHF HIGH BAND,PIN=60-100W, POUT=500W
906	2	DSTRAK91061	FOUR PORT DDM
228	1	BLN6200	AC POWER STRIP, 6 OUTLET
207	1	DS268132	INVERTER, 1 KVA, 48VDCIN/120VACOUT 2RU RM 19/23 IN NEWMAR 48-1000RM
207	1	DS502653	BREAKER 10A 1P AUX 5/16 BULLET
207	1	DS502656	25 AMP CIRCUIT BREAKER

APC	QTY	NOMENCLATURE	DESCRIPTION
207	1	DS46353505	CHATSWORTH 19 INCH EQUIPMENT RACK 7.5 FT
112	1	F2979	MLC 8000
112	1	VA00783AA	ADD: ANALOG CONVENTIONAL SIMULCAST COMPARATOR/GATEWAY
112	1	VA00012AA	ADD: 120/240VAC TO +12VDC POWER ADAPTER
112	1	VA00011AA	19INCH RACK MOUNT HARDWARE KIT CABINET OR RACK
147	1	CLN1856	2620-24 ETHERNET SWITCH
147	1	SQM01SUM0205	GGM 8000 GATEWAY
147	1	CA01616AA	ADD: AC POWER
112	1	F2979	MLC 8000
112	1	VA00783AA	ADD: ANALOG CONVENTIONAL SIMULCAST COMPARATOR/GATEWAY
112	1	VA00012AA	ADD: 120/240VAC TO +12VDC POWER ADAPTER
112	1	VA00011AA	19INCH RACK MOUNT HARDWARE KIT CABINET OR RACK
112	1	T7039	GTR 8000 Base Radio
112	1	CA00855AA	ADD: 700/800 MHZ
595	1	CA01949AA	ADD: ANALOG ONLY CONV SW
595	1	CA01952AA	ADD: ANALOG CONVENTIONAL SIMULCAST SOFTWARE
112	1	X265AH	ADD: BR PRESELECTOR, 800 MHZ
112	1	X153AW	ADD: RACK MOUNT HARDWARE
906	2	DSTRAK91061	FOUR PORT DDM
207	1	DSRMP615A	SPD, TYPE 3, 120V RACK MOUNT, 15A PLUG-IN W/ (6) 15A NEMA 5-15 OUTLETS
147	1	SQM01SUM0205	GGM 8000 GATEWAY
147	1	CA01616AA	ADD: AC POWER
147	1	CA02141AA	ADD: LOW DENSITY ENH CONV GATEWAY
207	1	DS46353505	CHATSWORTH 19 INCH EQUIPMENT RACK 7.5 FT
147	1	CLN1856	2620-24 ETHERNET SWITCH
147	1	SQM01SUM0205	GGM 8000 GATEWAY
147	1	CA01619AA	ADD: DC POWER
112	1	F2979	MLC 8000
112	1	VA00783AA	ADD: ANALOG CONVENTIONAL SIMULCAST COMPARATOR/GATEWAY
112	1	VA00012AA	ADD: 120/240VAC TO +12VDC POWER ADAPTER
112	1	VA00011AA	19INCH RACK MOUNT HARDWARE KIT CABINET OR RACK
112	1	T7039	GTR 8000 Base Radio
112	1	CA00855AA	ADD: 700/800 MHZ
595	1	CA01949AA	ADD: ANALOG ONLY CONV SW



APC	QTY	NOMENCLATURE	DESCRIPTION
595	1	CA01952AA	ADD: ANALOG CONVENTIONAL SIMULCAST SOFTWARE
112	1	X265AH	ADD: BR PRESELECTOR, 800 MHZ
112	1	CA01400AA	ADD: POWER CABLE, DC
112	1	X153AW	ADD: RACK MOUNT HARDWARE
906	2	DSTRAK91061	FOUR PORT DDM
228	1	BLN6200	AC POWER STRIP, 6 OUTLET
207	1	DS268132	INVERTER, 1 KVA, 48VDCIN/120VACOUT 2RU RM 19/23 IN NEWMAR 48-1000RM
207	1	DS502653	BREAKER 10A 1P AUX 5/16 BULLET
207	1	DS502656	25 AMP CIRCUIT BREAKER
207	1	DS46353505	CHATSWORTH 19 INCH EQUIPMENT RACK 7.5 FT
147	1	CLN1856	2620-24 ETHERNET SWITCH
147	1	SQM01SUM0205	GGM 8000 GATEWAY
147	1	CA01619AA	ADD: DC POWER
112	1	F2979	MLC 8000
112	1	VA00783AA	ADD: ANALOG CONVENTIONAL SIMULCAST COMPARATOR/GATEWAY
112	1	VA00012AA	ADD: 120/240VAC TO +12VDC POWER ADAPTER
112	1	VA00011AA	19INCH RACK MOUNT HARDWARE KIT CABINET OR RACK
112	1	T7039	GTR 8000 Base Radio
112	1	CA00855AA	ADD: 700/800 MHZ
595	1	CA01949AA	ADD: ANALOG ONLY CONV SW
595	1	CA01952AA	ADD: ANALOG CONVENTIONAL SIMULCAST SOFTWARE
112	1	X265AH	ADD: BR PRESELECTOR, 800 MHZ
112	1	CA01400AA	ADD: POWER CABLE, DC
112	1	X153AW	ADD: RACK MOUNT HARDWARE
906	2	DSTRAK91061	FOUR PORT DDM
228	1	BLN6200	AC POWER STRIP, 6 OUTLET
207	1	DS268132	INVERTER, 1 KVA, 48VDCIN/120VACOUT 2RU RM 19/23 IN NEWMAR 48-1000RM
207	1	DS502653	BREAKER 10A 1P AUX 5/16 BULLET
207	1	DS502656	25 AMP CIRCUIT BREAKER
207	1	DS46353505	CHATSWORTH 19 INCH EQUIPMENT RACK 7.5 FT
147	1	CLN1856	2620-24 ETHERNET SWITCH
147	1	SQM01SUM0205	GGM 8000 GATEWAY
147	1	CA01619AA	ADD: DC POWER
112	1	F2979	MLC 8000
112	1	VA00783AA	ADD: ANALOG CONVENTIONAL SIMULCAST COMPARATOR/GATEWAY
112	1	VA00012AA	ADD: 120/240VAC TO +12VDC POWER ADAPTER

APC	QTY	NOMENCLATURE	DESCRIPTION
112	1	VA00011AA	19INCH RACK MOUNT HARDWARE KIT CABINET OR RACK
112	1	T7039	GTR 8000 Base Radio
112	1	CA00855AA	ADD: 700/800 MHZ
595	1	CA01949AA	ADD: ANALOG ONLY CONV SW
595	1	CA01952AA	ADD: ANALOG CONVENTIONAL SIMULCAST SOFTWARE
112	1	X265AH	ADD: BR PRESELECTOR, 800 MHZ
112	1	CA01400AA	ADD: POWER CABLE, DC
112	1	X153AW	ADD: RACK MOUNT HARDWARE
906	2	DSTRAK91061	FOUR PORT DDM
228	1	BLN6200	AC POWER STRIP, 6 OUTLET
207	1	DS268132	INVERTER, 1 KVA, 48VDCIN/120VACOUT 2RU RM 19/23 IN NEWMAR 48-1000RM
207	1	DS502653	BREAKER 10A 1P AUX 5/16 BULLET
207	1	DS502656	25 AMP CIRCUIT BREAKER
207	1	DS46353505	CHATSWORTH 19 INCH EQUIPMENT RACK 7.5 FT
708	1	TT2490	AIC - ALERTING INTERFACE CONTROLLER LESS ACE3600
708	1	TT2506	MACH ALERT RACKMOUNT SERVER HARDWARE FOR UP TO 128 STATIONS
708	1	TT2490	AIC - ALERTING INTERFACE CONTROLLER LESS ACE3600
708	1	TT2506	MACH ALERT RACKMOUNT SERVER HARDWARE FOR UP TO 128 STATIONS
708	28	TT2494	BASIC STATION CONTROLLER ASSEMBLY LESS ACE3600
708	28	TT2497	MOUNT DIGITAL VOICE DISPATCH RADIO
708	2	TT2511	AIC-128 SOFTWARE
708	1	TT2509	MACH ALERT PRIMARY SOFTWARE LICENSE UP TO 64 STATIONS
708	1	TT2503	MACH ALERT SECONDARY SOFTWARE LICENSE UP TO 64 STATIONS
708	28	TT2488	STATION CONTROLLER SOFTWARE LICENSE
708	3	TT2514	MACH ALERT CLIENT LICENSE FOR UP TO 64 STATIONS
085	1	F7509	ACE3600 BASIC MODEL NO RADIO
085	1	V103	ADD: 3 I/O SLOTS FRAME
085	1	V212	ADD: PLUG-IN ETHERNET 10/100 M PORT
085	1	V261	OPTN,CHGR,ADD: AC PWR PS 100-240 V W/ BAT CHGR
085	1	V114	ADD: 6.5 AH BACKUP BATTERY
085	1	V051	19 ADJUSTABLE INSTAL BRACK
085	1	V269	ADD: EXPANDED 19 CHAS



APC	QTY	NOMENCLATURE	DESCRIPTION
085	1	V20	ADD: BLANK MODULE
085	1	V448	ADD: ACE3600 CPU3680
085	28	F7509	ACE3600 BASIC MODEL NO RADIO
085	28	V214	ADD: 38 X 38 CM METAL CHASSIS
085	28	V261	OPTN,CHGR,ADD: AC PWR PS 100-240 V W/ BAT CHGR
085	28	V114	ADD: 6.5 AH BACKUP BATTERY
085	28	V103	ADD: 3 I/O SLOTS FRAME
085	28	V184	ADD: PLUG-IN RS-232 PORT
085	28	V481	ADD: 32 DO / DI FET
085	56	V20	ADD: BLANK MODULE
085	28	V358	ADD: 40 WIRE CABLE W/ TB HOLDER 3 M
085	28	V448	ADD: ACE3600 CPU3680
085	28	FLN3649	XTL5000/2500 DIGITAL INSTALLATION KIT
147	7	CLN1856	2620-24 ETHERNET SWITCH
147	7	SQM01SUM0205	GGM 8000 GATEWAY
147	7	CA01616AA	ADD: AC POWER
147	1	SQM01SUM0205	GGM 8000 GATEWAY
147	1	CA01616AA	ADD: AC POWER
147	1	CA02086AA	ADD: HIGH DENSITY ENH CONV GATEWAY
207	7	DS46353505	CHATSWORTH 19 INCH EQUIPMENT RACK 7.5 FT
207	7	DSOP820B	PDU, 120V HARDWIRE (8) 20A OUTLET PDU WITH TYPE 3 SAD PROTECTION
207	7	DS1101378	RACK MT ADAPTER PLATE, 19 IN FOR DSOP820B, DSOP820B2 & DSNSOP820B
228	7	BLN6200	AC POWER STRIP, 6 OUTLET
112	1	F2979	MLC 8000
112	1	VA00784AA	ANALOG CONVENTIONAL VOTING COMPARATOR/GATEWAY
112	1	VA00012AA	ADD: 120/240VAC TO +12VDC POWER ADAPTER
112	1	VA00011AA	19INCH RACK MOUNT HARDWARE KIT CABINET OR RACK
112	6	F2979	MLC 8000
112	6	VA00784AA	ANALOG CONVENTIONAL VOTING COMPARATOR/GATEWAY
112	6	VA00012AA	ADD: 120/240VAC TO +12VDC POWER ADAPTER
112	6	VA00011AA	19INCH RACK MOUNT HARDWARE KIT CABINET OR RACK
112	1	T7039	GTR 8000 Base Radio
112	1	X640AL	ADD: UHF R2 (435-524 MHZ)
595	1	CA01949AA	ADD: ANALOG ONLY CONV SW
595	1	CA01952AA	ADD: ANALOG CONVENTIONAL SIMULCAST SOFTWARE

APC	QTY	NOMENCLATURE	DESCRIPTION
112	1	X265AP	ADD: BR PRESELECTOR 380-512 MHZ
112	1	X153AW	ADD: RACK MOUNT HARDWARE
207	1	DQPA62GFHMS	POWER AMP, PIN=20-45W, POUT=300W, 400-512 MHZ, OPERATING BW 20 MHZ
112	1	F2979	MLC 8000
112	1	VA00784AA	ANALOG CONVENTIONAL VOTING COMPARATOR/GATEWAY
112	1	VA00012AA	ADD: 120/240VAC TO +12VDC POWER ADAPTER
112	1	VA00011AA	19INCH RACK MOUNT HARDWARE KIT CABINET OR RACK
112	5	F2979	MLC 8000
112	5	VA00784AA	ANALOG CONVENTIONAL VOTING COMPARATOR/GATEWAY
112	5	VA00012AA	ADD: 120/240VAC TO +12VDC POWER ADAPTER
112	5	VA00011AA	19INCH RACK MOUNT HARDWARE KIT CABINET OR RACK
112	1	T7039	GTR 8000 Base Radio
112	1	X640AL	ADD: UHF R2 (435-524 MHZ)
595	1	CA01949AA	ADD: ANALOG ONLY CONV SW
595	1	CA01952AA	ADD: ANALOG CONVENTIONAL SIMULCAST SOFTWARE
112	1	X265AP	ADD: BR PRESELECTOR 380-512 MHZ
112	1	X153AW	ADD: RACK MOUNT HARDWARE
112	1	F2979	MLC 8000
112	1	VA00784AA	ANALOG CONVENTIONAL VOTING COMPARATOR/GATEWAY
112	1	VA00012AA	ADD: 120/240VAC TO +12VDC POWER ADAPTER
112	1	VA00011AA	19INCH RACK MOUNT HARDWARE KIT CABINET OR RACK
112	5	F2979	MLC 8000
112	5	VA00784AA	ANALOG CONVENTIONAL VOTING COMPARATOR/GATEWAY
112	5	VA00012AA	ADD: 120/240VAC TO +12VDC POWER ADAPTER
112	5	VA00011AA	19INCH RACK MOUNT HARDWARE KIT CABINET OR RACK
112	1	T7039	GTR 8000 Base Radio
112	1	X640AL	ADD: UHF R2 (435-524 MHZ)
595	1	CA01949AA	ADD: ANALOG ONLY CONV SW
595	1	CA01952AA	ADD: ANALOG CONVENTIONAL SIMULCAST SOFTWARE
112	1	X265AP	ADD: BR PRESELECTOR 380-512 MHZ
112	1	X153AW	ADD: RACK MOUNT HARDWARE
112	1	T7540	GPW 8000 RECEIVER
112	1	X640AN	ADD: UHF R2 (435-524 MHZ)



APC	QTY	NOMENCLATURE	DESCRIPTION
595	1	CA01949AB	ADD: ANALOG ONLY CONV SW R/X ONLY
112	1	X265AZ	ADD: NARROW PRESELECTOR 470-512 MHZ
112	1	X153AW	ADD: RACK MOUNT HARDWARE
112	1	X301AR	ADD: QTY 1 GPW 8000 RECEIVER
112	1	T7540	GPW 8000 RECEIVER
112	1	X640AN	ADD: UHF R2 (435-524 MHZ)
595	1	CA01949AB	ADD: ANALOG ONLY CONV SW R/X ONLY
112	1	X265AZ	ADD: NARROW PRESELECTOR 470-512 MHZ
112	1	X153AW	ADD: RACK MOUNT HARDWARE
112	1	X301AR	ADD: QTY 1 GPW 8000 RECEIVER
112	1	T7540	GPW 8000 RECEIVER
112	1	X640AN	ADD: UHF R2 (435-524 MHZ)
595	1	CA01949AB	ADD: ANALOG ONLY CONV SW R/X ONLY
112	1	X265AZ	ADD: NARROW PRESELECTOR 470-512 MHZ
112	1	X153AW	ADD: RACK MOUNT HARDWARE
112	1	X301AR	ADD: QTY 1 GPW 8000 RECEIVER
112	1	T7540	GPW 8000 RECEIVER
112	1	X640AN	ADD: UHF R2 (435-524 MHZ)
595	1	CA01949AB	ADD: ANALOG ONLY CONV SW R/X ONLY
112	1	X265AZ	ADD: NARROW PRESELECTOR 470-512 MHZ
112	1	X153AW	ADD: RACK MOUNT HARDWARE
112	1	X301AR	ADD: QTY 1 GPW 8000 RECEIVER
112	1	F2979	MLC 8000
112	1	VA00784AA	ANALOG CONVENTIONAL VOTING COMPARATOR/GATEWAY
112	1	VA00012AA	ADD: 120/240VAC TO +12VDC POWER ADAPTER
112	1	VA00011AA	19INCH RACK MOUNT HARDWARE KIT CABINET OR RACK
112	6	F2979	MLC 8000
112	6	VA00784AA	ANALOG CONVENTIONAL VOTING COMPARATOR/GATEWAY
112	6	VA00012AA	ADD: 120/240VAC TO +12VDC POWER ADAPTER
112	6	VA00011AA	19INCH RACK MOUNT HARDWARE KIT CABINET OR RACK
112	1	F2979	MLC 8000
112	1	VA00784AA	ANALOG CONVENTIONAL VOTING COMPARATOR/GATEWAY
112	1	VA00012AA	ADD: 120/240VAC TO +12VDC POWER ADAPTER
112	1	VA00011AA	19INCH RACK MOUNT HARDWARE KIT CABINET OR RACK
112	6	F2979	MLC 8000

APC	QTY	NOMENCLATURE	DESCRIPTION
112	6	VA00784AA	ANALOG CONVENTIONAL VOTING COMPARATOR/GATEWAY
112	6	VA00012AA	ADD: 120/240VAC TO +12VDC POWER ADAPTER
112	6	VA00011AA	19INCH RACK MOUNT HARDWARE KIT CABINET OR RACK
112	1	F2979	MLC 8000
112	1	VA00784AA	ANALOG CONVENTIONAL VOTING COMPARATOR/GATEWAY
112	1	VA00012AA	ADD: 120/240VAC TO +12VDC POWER ADAPTER
112	1	VA00011AA	19INCH RACK MOUNT HARDWARE KIT CABINET OR RACK
112	5	F2979	MLC 8000
112	5	VA00784AA	ANALOG CONVENTIONAL VOTING COMPARATOR/GATEWAY
112	5	VA00012AA	ADD: 120/240VAC TO +12VDC POWER ADAPTER
112	5	VA00011AA	19INCH RACK MOUNT HARDWARE KIT CABINET OR RACK
112	1	T7039	GTR 8000 Base Radio
112	1	X530BG	ADD: VHF (136-174 MHZ)
595	1	CA01949AA	ADD: ANALOG ONLY CONV SW
595	1	CA01952AA	ADD: ANALOG CONVENTIONAL SIMULCAST SOFTWARE
112	1	X265AM	BR PRESELCTOR, 150-174 MHZ
112	1	CA01400AA	ADD: POWER CABLE, DC
112	1	X153AW	ADD: RACK MOUNT HARDWARE
112	1	CA01504AA	ADD: ANTENNA RELAY
457	1	DSPA32GGHMS	POWER AMPLIFIER, PA3-2GG-HMS VHF HIGH BAND,PIN=60-100W, POUT=500W
207	1	DS280700	DC SYSTEM FP2 -48/300 BD 19 2BT
207	4	DS241115105	RECTIFIER, FLATPACK 2 48/2000 HE
207	3	DS236408	BLIND PANEL FP2 HE BLACK G1
207	1	DS268132	INVERTER, 1 KVA, 48VDCIN/120VACOUT 2RU RM 19/23 IN NEWMAR 48-1000RM
207	1	DS502656	25 AMP CIRCUIT BREAKER
207	2	DS502877	48V 125AH 12V125F ENERSYS BATT SET
207	2	DS502653	BREAKER 10A 1P AUX 5/16 BULLET
207	18	DS502652	5 AMP CIRCUIT BREAKER
207	2	DS230700	KIT: BATTERY MONITOR 10M G1, BATTERY MONITOR CAN BUS NODE
207	1	DQDUALP9711093 B	DUAL LIGHTING SYSTEM
351	1	DSRM200008VQ10 B	EIGHT PORT VHF 132-174 MHZ QUADRATURE RM DECK -48 VAC

APC	QTY	NOMENCLATURE	DESCRIPTION
351	1	DSRM300008VQ10 B	EIGHT PORT UHF 380-512 MHZ QUADRATURE RM DECK -48 VAC
351	1	DSSD214SF2P4LDF	LOW PIM 4 DIPOLE (STD VERSION), 138-174MHZ,OFFSET, 7.5 DBD GAIN
351	15	L1705	LDF4-50A CABLE: 1/2" LDF HELIAX POLY JKT PER FOOT
351	1	DDN1088	L4TNM-PSA TYPE N MALE PS FOR 1/2 IN CABLE
351	1	DDN1090	L4TDM-PSA 7-16 DIN MALE PS FOR 1/2 IN CABLE
351	2	TDN9289	221213 CABLE WRAP WEATHERPROOFING
351	300	L3617	7/8IN HELIAX VIRTUAL AIR FOAM FILLED CORRUGATED CABLE (AVA5-50FX)/FOOT
351	2	DDN1079	78EZNFM N FEMALE MOT CONNECTOR (MOTOROLA SPECIFIC)
351	6	DSSG7806B2A	SG78-06B2A GROUNDING KIT FOR 7/8 IN COAXIAL CABLE
351	2	DSL5SGRIP	L5SGRIP 7/8" SUPPORT HOIST GRIP
351	10	MDN6817	42396A-5 7/8" CABLE HANGER STAINLESS, 10 PK
207	1	DSIS50NXC2MA	RF SPD, 125-1000MHZ DC BLOCK FLANGE MT NM ANTENNA, NF EQUIPMENT SIDE
351	25	L1702	FSJ4-50B CABLE: 1/2" SUPERFLEX POLY JKT PER FOOT
351	2	DDN9682	F4PNMV2-HC 1/2" TYPE N MALE PLATED CONNECTOR
351	1	DSSD318HF2P4LDF	EXPOSED DIPOLE DIRECTIVE ANT, 10.5 DBD, HD, WIDE BAND, 406-470MHZ, DIN
351	15	L1705	LDF4-50A CABLE: 1/2" LDF HELIAX POLY JKT PER FOOT
351	1	DDN1088	L4TNM-PSA TYPE N MALE PS FOR 1/2 IN CABLE
351	1	DDN1090	L4TDM-PSA 7-16 DIN MALE PS FOR 1/2 IN CABLE
351	2	TDN9289	221213 CABLE WRAP WEATHERPROOFING
351	300	L3617	7/8IN HELIAX VIRTUAL AIR FOAM FILLED CORRUGATED CABLE (AVA5-50FX)/FOOT
351	2	DDN1079	78EZNFM N FEMALE MOT CONNECTOR (MOTOROLA SPECIFIC)
351	6	DSSG7806B2A	SG78-06B2A GROUNDING KIT FOR 7/8 IN COAXIAL CABLE
351	2	DSL5SGRIP	L5SGRIP 7/8" SUPPORT HOIST GRIP
351	10	MDN6817	42396A-5 7/8" CABLE HANGER STAINLESS, 10 PK
207	1	DSCGXZ36NMNFA	RF SPD, 400-1200MHZ HYBRID +36 VDC PASS NM ANTENNA, NF EQUIPMENT
351	25	L1702	FSJ4-50B CABLE: 1/2" SUPERFLEX POLY JKT PER FOOT
351	2	DDN9682	F4PNMV2-HC 1/2" TYPE N MALE PLATED CONNECTOR

SECTION C-3

STATEMENT OF WORK

METROSAFE COMMUNICATIONS MIGRATION PLAN

FEBRUARY 2015



The design, technical, pricing, and other information ("Information") furnished with this submission is proprietary information of Motorola Solutions, Inc. ("Motorola") and is submitted with the restriction that it is to be used for evaluation purposes only. To the fullest extent allowed by applicable law, the Information is not to be disclosed publicly or in any manner to anyone other than those required to evaluate the Information without the express written permission of Motorola.

MOTOROLA, MOTO, MOTOROLA SOLUTIONS, and the Stylized M Logo are trademarks or registered trademarks of Motorola Trademark Holdings, LLC and are used under license. SYMBOL is a trademark owned by Symbol Technologies, Inc., which is a wholly owned subsidiary of Motorola Solutions, Inc. All other trademarks are the property of their respective owners. © 2013 Motorola Solutions, Inc. All rights reserved.

TABLE OF CONTENTS

Section C-3

Statement of Work	1
4.1 Project Resources	1
4.1.1 Motorola Project Manager.....	1
4.1.2 Motorola System Engineer.....	2
4.1.3 Motorola System Technologist.....	3
4.1.4 Motorola Customer Support Manager	3
4.1.5 Motorola Subcontractors.....	3
4.1.5.1 NICE	3
4.1.5.2 Owens Communications (OCI).....	4
4.2 Standards and Guidelines	4
4.2.1 Site Cleanup	4
4.2.2 Quality Management.....	4
4.2.3 Safety and Health	4
4.3 Frequency Coordination and Licensing.....	5
4.4 Site Readiness Survey	5
4.5 Implementation Schedule	5
4.6 Project PunchList.....	6
4.7 Customer Database.....	6
4.8 Site Development	6
4.9 Existing System Equipment	6
4.10 Equipment Racks/Cabinet	6
4.11 Equipment Warehousing/Storage	6
4.12 Spare Equipment.....	7
4.13 Existing System Interruptions	7
4.14 Subscribers	7
4.15 Coverage Testing	7
4.16 Project Status Meetings.....	7
4.17 Final System Acceptance	8
4.18 Milestone Completions	8
4.19 General Assumptions	8
4.20 Project Lifecycle Phases and Responsibilities	8
4.20.1 Contract Award/Project Initiation (Milestone)	9
4.20.1.1 Contract Administration.....	9
4.20.1.2 Project Kickoff	9
4.20.2 Contract Design Review (CDR)	10
4.20.2.1 Review Contract Design.....	10
4.20.3 Order Processing.....	10
4.20.3.1 Process Equipment List	10



4.20.4	Manufacturing and Staging	11
4.20.4.1	Manufacture and Procure Fixed Network Equipment	11
4.20.4.2	Ship to Staging (Milestone)	11
4.20.4.3	Stage System.....	11
4.20.4.4	Perform Factory Acceptance Test Procedures (FATP).....	12
4.20.4.5	CCSi Ship Acceptance (Milestone)	12
4.20.5	Site Development	12
4.21	Equipment Installation	12
4.21.1	Bardstown Road Tower Site	12
4.21.2	Fern Creek Tower Site.....	13
4.21.3	Old Mitchell Hill Tower Site	14
4.21.4	Microwave Backhaul Network	14
4.21.5	Fixed Network Master Core/Prime/RF Equipment.....	15
4.21.6	Console Installation.....	16
4.21.7	RF Logging Equipment	16
4.21.8	Fire Station Alerting (FSA)	17
4.21.9	WAVE Application.....	18
4.21.10	System Installation Acceptance (Milestone).....	18
4.21.11	System Optimization.....	18
4.21.11.1	Optimize System FNE.....	18
4.21.11.2	Optimization Complete.....	19
4.21.12	Training.....	19
4.21.12.1	Perform Training	19
4.21.12.2	Training Complete.....	19
4.21.13	Functional Acceptance Testing	19
4.21.13.1	Perform On-Site Acceptance Testing	20
4.21.13.2	Perform System Functional Testing	20
4.21.14	Finalize	20
4.21.14.1	Cutover	20
4.21.14.2	Transition to Service/Project Transition Certificate	21
4.21.14.3	As-Built Documentation.....	21
4.21.14.4	Final System Acceptance (Milestone)	21
4.21.15	Change Orders	21
4.22	Appendix A – NICE Remote Access Approval Form.....	23
4.1	Training	25
4.1.1	Overview	25
4.1.2	Training Approach	25
4.1.3	Courses Proposed.....	26
4.1.3.1	System Technical Training.....	27
4.1.4	Course Descriptions	31

STATEMENT OF WORK

This document, known as the Statement of Work (SOW), describes the deliverables to be furnished to City of Louisville / Jefferson County, Kentucky (“MetroSafe” or “Customer”), and the tasks to be performed by Motorola, its subcontractors, and MetroSafe to implement the solution described in this proposal. It describes the actual work involved in installation and clarifies the responsibilities for both Motorola and MetroSafe during the project implementation. Specifically, this SOW provides:

- A summary of the phases and tasks to be completed within the project lifecycle.
- A list of the deliverables associated with the project.
- A description of the responsibilities for Motorola and MetroSafe.
- The qualifications and assumptions taken into consideration during the development of this project.

This SOW is a working document that may be revised as needed to incorporate any changes associated with contract negotiations, Contract Design Review (CDR), and any change orders that may occur during the execution of the project.

4.1 PROJECT RESOURCES

Motorola has organized project resources into a Systems Integration (SI) group to meet the needs of implementing sophisticated communications technology. This organization is involved from system conception to system completion.

The Motorola SI group assembles a team for each project to fulfill Customer-specific requirements. The Motorola SI group and MetroSafe team members will form a partnership dedicated to addressing MetroSafe’s needs.

4.1.1 Motorola Project Manager

The Project Manager has full responsibility for the successful completion of the implementation lifecycle from start to finish. The tasks of the Project Manager include, but are not limited to, the following:

- Act as main point of contact between MetroSafe Project Manager and Motorola resources throughout the entire project lifecycle.
- Develop and manage project plan, schedule, quality, and risk.
- Oversee and manage day-to-day activities, deliverables, and milestone completions.
- Manage/supervise field installation and implementation teams to ensure that all on-site installation, integration, and optimization tasks are performed per contract requirements, industry best practices, and applicable standards and guidelines.
- Develop, update, and maintain a detailed implementation schedule to include work tasks with predecessors, milestones, start/end dates, and task resource(s).
- Distribute updated implementation schedule to MetroSafe one day prior to each bi-weekly status meeting.
- Participate with MetroSafe in progress review meetings bi-weekly or as deemed necessary throughout the project lifecycle:
 - Generate mutually agreed upon meeting agenda.



- Manage and submit project status reports that identify the activities of the previous review period, as well as activities planned for the upcoming review period, including an updated implementation schedule.
- Document and distribute bi-weekly meeting minutes to MetroSafe within five (5) business days after each meeting.
- Provide 800 conference and pin numbers to participants for non face-to-face meetings.
- Develop, update, maintain, and distribute project punch list.
- Inspect and maintain inventory of all received equipment to ensure total delivery.
- Inspect each site to ensure readiness for receiving and installing of site equipment.
- Support hardware implementation with proper documentation, guidance and training to ensure quality workmanship and Customer satisfaction by all Motorola vendors and subcontractors.
- Coordinate closely with Customer Project Manager any needed interruptions to the existing system during implementation of the new system.
- Issue status reports that include the project status, milestones achieved, tasks behind schedule, actual and potential problems.
- Resolve deviations from the implementation schedule.
- Monitor the project to ensure that support resources are available as scheduled and as identified in the contract.
- Assume accountability for all Motorola contractor and subcontractor supplied tasks within the implementation schedule.
- Review and administer change control procedures with MetroSafe Project Manager.
- Provide timely responses to issues related to project progress raised by the MetroSafe Project Manager.
- Work with the MetroSafe Project Manager in designing and approving the format of an action item log to be used in conjunction with the implementation schedule. The purpose of the log is to identify outstanding issues, provide continual status updates on specific tasks and to identify responsibilities of the parties.

4.1.2 Motorola System Engineer

The Project Engineer has full responsibility for system design and performance. The Project Engineer's primary responsibility is to ensure the technical integrity of the system design to contract throughout the entire project lifecycle. The Project Engineer's other tasks include:

- Development of system installation and upgrade documents (i.e. equipment list or bill of materials, system level diagram, and rack-up drawings).
- Define MetroSafe's communication needs, design the preliminary system, and participate in the Detailed Design Review to finalize and confirm the system design to meet Customer's requirements.
- Define Motorola and Customer demarcation points.
- Define technical requirements for interfacing with Motorola-supplied equipment.
- Complete the process of defining, documenting, and acquiring MetroSafe's approval of system programming and configuration.
- Participate in the system and functionality testing at the Customer Center for System Integration (CCSi, Motorola staging facility located in Schaumburg, IL).
- Responsible for the process of defining, documenting and executing functionality acceptance testing once the system is field installed.
- Develop, participate, train/educate, and oversee execution of system acceptance test plans
- Develop cutover plan that will balance MetroSafe's needs and approval with installation logistics.
- Provide systems and network engineering support throughout the implementation lifecycle.

4.1.3 Motorola System Technologist

The System Technologist has the primary responsibility as the “hands-on” system expert. The System Technologist’s tasks include:

- Work with the Project Engineer to ensure the integrity of the design during system installation and testing.
- Participate in the staging and testing of the system at the Customer Center for System Integration (CCSi).
- Perform the optimization of the Radio Frequency (RF) equipment.
- Participate in system equipment testing and acceptance.
- Deliver and install equipment per Motorola R56 installation and grounding guidelines and other applicable standards.

4.1.4 Motorola Customer Support Manager

The Customer Support Manager establishes the maintenance and service support program throughout the warranty and post-warranty periods. Other tasks include:

- Coordinates Motorola service support resources to enhance the quality of service delivery and to ensure MetroSafe’s satisfaction over the life of their communication’s system.
- Oversee the execution of MetroSafe’s support contract (maintenance or warranty).
- Serves as the single point of contact for service issue resolution and escalation.

4.1.5 Motorola Subcontractors

Motorola’s Project Manager will coordinate the activities of the subcontractors to assure cost-effective performance and resolution of technical interface issues during design as opposed to during integration activities.

Motorola’s Project Manager will be the single authority for subcontract actions and reporting and will have the full responsibility for quality performance, schedules, and cost control. We will use a straightforward procedure for managing and controlling work assignments to subcontractors.

Subcontractors selected for this project based on their experience and many have worked for Motorola on numerous projects. Each subcontractor will assign a lead manager who will be responsible for its company’s performance. These managers will report directly to Motorola’s Project Manager on scheduling and implementation issues and to the System Engineer on specific technical assignments. All subcontractors will submit as-needed progress reports to Motorola describing progress, level of effort, and anticipated problems which will be integrated into the project’s tracking system. The subcontractors’ weekly progress reports will serve as Motorola’s primary mechanism for ensuring that they remain on track to deliver their promised results.

4.1.5.1 NICE

NICE Systems is the worldwide leader of intent-based solutions that capture and analyze interactions and transactions, realize intent, and extract and leverage insights to deliver impact in real time. As a Motorola preferred supplier of logging solutions, NICE will be responsible for manufacturing, staging, programming, optimization, and acceptance testing of the logging solution proposed for City of Louisville / Jefferson County.



4.1.5.2 Owens Communications (OCI)

OCI is a Motorola Authorized Two-Way Radio Dealer, Authorized Motorola Wireless Networking Solutions Provider, Authorized Motorola Service Station (MSS), Authorized Manufacturers Representative for Motorola's Mission Critical State and Local Government Team, and the FIRST Authorized Agent for Motorola's Federal Government Group in Kentucky.

OCI will be responsible for first year warranty maintenance on-site support and Network Preventative Maintenance for new equipment. MetroSafe will continue providing on-site support for existing equipment under current maintenance agreement.

4.2 STANDARDS AND GUIDELINES

Motorola takes great care in designing our radio systems to meet or exceed the needs and safety of the users and the applicable industry standards. Motorola's end user equipment also exceeds many of the Military Standards for harsh environments. When shipping products and installing radio equipment, Motorola meets all the legally required standards and regulations.

Motorola shall be responsible for complete and fully operable installation of all items identified in accordance with the latest version of the Motorola's R56 standards, National Electrical Code, local building codes, environmental laws, zoning and planning regulations or ordinances, land use restrictions, OSHA and state safety requirements, and all other local, state or Federal codes, regulations, laws and/or ordinances as applicable. In the event there is a conflict between the referenced drawings, codes, specifications or standards, the most stringent will govern.

4.2.1 Site Cleanup

Motorola and its subcontractors shall clean-up and remove from the work site all rubbish and construction debris, resulting from their own work. Upon completion of work, the entire job site areas shall be left clean and free of trash, debris, scrap materials, and excess materials resulting from equipment installations. Upon completion of installation work, the radio equipment shelters and rooms shall be thoroughly cleaned to the satisfaction of the Motorola and Customer Project Managers. Motorola understands failure to comply with these requirements may result in the Customer contracting to have the inside and/or outside cleanup work performed at Motorola's cost.

4.2.2 Quality Management

It is the policy of Motorola to produce and provide products and services of the highest quality which are responsive to the needs of our Customers. Motorola has a well-established reputation for designing and developing high quality products and systems, on schedule, and within budget. Motorola adheres to the International Standards Organizations (ISO) quality standards.

All work will be performed consistent with high quality commercial practice and in accordance with Motorola's Quality Standards for Fixed Equipment Installations and all applicable manufacturer installation and maintenance manuals.

4.2.3 Safety and Health

Motorola holds safety as paramount; at no time shall any operation, task or evolution take place or be continued if deemed hazardous to the personnel, equipment or community. All safety practices shall be put in place and compliance with all local, state and federal laws and regulations shall be

maintained. Motorola and its subcontractors shall follow the following guidelines at all times during system installation:

- Work area will be posted in accordance with OSHA regulations (i.e. medical aide, hard hat, safety glasses, etc.).
- All personnel shall be compliant with OSHA regulations, and fully trained for the type of work to be performed.
- All team members shall ensure that the workplace is maintained clean and free of safety hazards.
- All trash and install debris shall be removed daily.
- A safety and security check will be conducted at the close of the workday.

4.3 FREQUENCY COORDINATION AND LICENSING

As licensee, Customer is responsible for applicable 800 MHz frequency licensing modifications and fees.

Restrictions:

- Motorola assumes no liability or responsibility for inadequate frequency availability or frequency licensing issues.
- Motorola is not responsible for issues outside of its immediate control. Such issues include, but are not restricted to, improper frequency coordination by others and non-compliant operation, improper design, installation, or operation of systems installed of other vendor radio channels/systems.

4.4 SITE READINESS SURVEY

Prior to starting any site upgrades or equipment installations, Motorola and MetroSafe shall conduct a site readiness review at each site to examine existing work, work performed by others, or work not included in this SOW, that is required to support the new radio system. The site readiness review documents any conditions that will prevent start of site upgrade or equipment installation work to be performed by Motorola and its subcontractors. Issues will be noted and responsible party(ies) must correct their deficiencies prior to system installation. Additional walks may be needed to confirm deficiencies have been properly corrected.

4.5 IMPLEMENTATION SCHEDULE

Motorola has developed a detailed implementation schedule outlining several key project tasks and milestones. During the implementation period, the Motorola Project Manager shall update the implementation schedule by the 15th day of each month. The Motorola Project Manager shall also provide a monthly report laying out progress achieved, a description of any delays and the cause of those delays, and a discussion of the effort that will be made to bring the Project back to the original schedule.

The following assumptions were considered when developing the project implementation schedule:

- Contract award date of August 3rd 2015.
- Based on the system as proposed with this offering.
- Detailed design review is completed and accepted within sixty (60) calendar days of contract award.
- Notices to proceed from Customer are completed/issued by scheduled dates.



- Customer responsibilities are completed within stated deadlines.

4.6 PROJECT PUNCHLIST

Motorola PM will be responsible for creating, maintaining, and distributing a project punch list throughout the project lifecycle (Contract Award to Final Acceptance). The punch list will be maintained in “real” time and distributed to all key project participants weekly. The punch list will be maintained in Microsoft Excel 2003 or later and will include the following details: sequential punch list item number, date identified, item description, party(ies) responsible for item resolution, expected resolution date, actual resolution date, description of resolution, and any other important notes about the punch list item.

The punch list will be reviewed at each status meeting. Closed items will be marked accordingly and moved to the appropriate closed section of the report.

4.7 CUSTOMER DATABASE

MetroSafe will need to “freeze” their 6.9 databases for Motorola to upgrade to 7.15. If Customer makes changes to the 6.9 database during the “freeze” period they will need to document those changes and re-enter to the 7.15 database.

4.8 SITE DEVELOPMENT

MetroSafe will be responsible for all applicable site equipment space, electrical, back-up power, grounding, facility, and tower upgrades necessary to accommodate the new equipment.

4.9 EXISTING SYSTEM EQUIPMENT

MetroSafe shall be responsible for relocating any existing equipment where necessary to make room for new proposed equipment.

MetroSafe shall be responsible for decommissioning and removing any existing equipment.

4.10 EQUIPMENT RACKS/CABINET

Equipment housed in open racks or closed cabinets will be arranged with heavier items installed from bottom up minimizing the effect of centrifugal forces or swaying of rack/cabinet during an earthquake.

4.11 EQUIPMENT WAREHOUSING/STORAGE

MetroSafe will be responsible for providing adequate floor space and secured warehousing/storage facility for housing new equipment until ready to be installed.



4.12 SPARE EQUIPMENT

Spare units will be provided unused and will not be used at any time during field installation or prior to final acceptance and start of 1st year warranty.

4.13 EXISTING SYSTEM INTERRUPTIONS

Motorola understands that the existing system(s) will be in full operation at time of installation and implementation of the new system. Motorola and its employees, agents, subcontractors, or servants will take every precaution as necessary to prevent any interruptions to the existing system(s).

Motorola Project Manager will notify Customer Project Manager in writing about any unavoidable interruptions. The written notification shall contain the following information:

- Reason for the interruption.
- Expected length of time of interruption.
- Detailed description and sequence of work to be performed during the interruption.

Motorola will not proceed with the planned interruption until a written confirmation from Customer Project Manager has been received.

4.14 SUBSCRIBERS

Customer will be responsible programming template development, programming, and installations.

4.15 COVERAGE TESTING

Coverage testing has not been included with this proposal.

4.16 PROJECT STATUS MEETINGS

The Motorola PM will schedule a bi-weekly call or meeting as determined at the kick-off meeting. The Motorola PM will be responsible for developing the agenda, providing project status reports (i.e. schedule, punch list, action items), and distributing meeting minutes to all participants within five (5) business days following completed bi-weekly meeting.

If the team decides to have a conference call at times versus face-to-face meeting, the Motorola PM will provide an 800 conference call number and pin for all meeting participants. For face-to-face meetings, MetroSafe would be responsible for providing meeting facility.

The agenda will include at a minimum the following topics:

- Overall project status compared to the Implementation schedule.
- Product or service related issues that may affect the Implementation schedule.
- Status of the action items, project deliverables, punchlist, changes, and risk.
- Any miscellaneous concerns of either MetroSafe or Motorola.

Motorola understands that MetroSafe may request at their discretion for the Motorola Project Manager to attend other meetings during installation outside the regularly scheduled bi-weekly meetings.



4.17 FINAL SYSTEM ACCEPTANCE

Motorola will develop and submit to MetroSafe a detailed Final Acceptance Test Plan (FATP) no later than 15 business days before the test is to begin. Motorola understands that MetroSafe will approve the FATP no later five business days before the test is to begin. The test will provide comprehensive list of tests that will be performed with MetroSafe present. Final system acceptance will not be deemed successful until all tests pass, all punch list items identified during the FATP are marked complete, all deliverables of this SOW are complete, and MetroSafe and Motorola approve the event by signing a Final System Acceptance milestone completion form.

4.18 MILESTONE COMPLETIONS

Several key milestones have been provided as part of the implementation schedule. This list of milestones will be reviewed and approved by Motorola and MetroSafe at the detailed design review. The Motorola PM will make necessary adjustments to the implementation schedule to reflect the final list of milestones agreed to at the detailed design review.

The Motorola PM will be responsible for generating each milestone completion certificate for MetroSafe's review and when deemed necessary for Motorola and MetroSafe to commemorate a completed milestone. The original copy of the signed certificate will be provided to MetroSafe and a copy of the certificate will be provided to Motorola.

Major Key Milestones:

- Contract award.
- Contract Design Review.
- Stage/ship acceptance.
- Site construction.
 - Mobilization.
 - Substantial completion (final punchlist notation).
 - Closeout.
- Installation acceptance.
- System technical training completion.
- Acceptance testing.
- Final acceptance.

4.19 GENERAL ASSUMPTIONS

- No prevailing wage, certified payroll, mandatory union workers or mandatory minority workers are required for this work.
- All work is assumed to be done during normal business hours as dictated by time zone (Monday thru Friday, 7:30 a.m. to 5:00 p.m.).
- Temporary site trailers (tower, housing, COWS, and generator) have not been included to aid in cutover of end users to the new system.

4.20 PROJECT LIFECYCLE PHASES AND RESPONSIBILITIES

Based on many years of experience, Motorola has developed a project implementation methodology that identifies major project phases – Contract/Project Initiation (Award), Detailed Design Review,

Order Processing, Manufacturing and Staging, Site Development, Installation, System Optimization, Acceptance Testing, and Project Closeout.

Throughout the duration of this project, Motorola will provide the equipment and services within each phase as described within this proposal. Detailed descriptions of the specific tasks associated with the individual phases are contained in the following sections.

4.20.1 Contract Award/Project Initiation (Milestone)

- MetroSafe and Motorola execute the contract and both parties receive all the necessary supporting contract documentation.

4.20.1.1 Contract Administration

Motorola Responsibilities:

- Assign a Project Manager, as the single point of contact throughout the duration of the project lifecycle, with authority to make project decisions.
- Assign other required resources necessary for project implementation.

Customer Responsibilities:

- Assign a Project Manager, as the single point of contact responsible for Customer-signed approvals.
- Assign other resources necessary to ensure completion of project tasks for which MetroSafe is responsible.

Completion Criteria:

- Motorola internal processes are set up for project management.
- Assignment of Motorola and MetroSafe project resources are complete.
- Project kickoff meeting is scheduled.

4.20.1.2 Project Kickoff

Motorola Responsibilities:

- Conduct project kickoff meeting with MetroSafe at Customer location.
- Introduce and review the roles of the project participants to identify communication flows and decision-making authority between project participants.
- Review the overall project scope and objectives.
- Review the resource and scheduling requirements.
- Review the Implementation schedule to address upcoming milestones and/or events.
- Review the teams' interactions (Motorola and MetroSafe) or Communication Plan, meetings, reports, milestone acceptance, and MetroSafe's participation in particular phases.
- Schedule Detailed Design Review.
- Document and distribute meeting notes to all participants within five (5) business days of completing the kick-off meeting.

Customer Responsibilities:

- Provide local meeting place.
- MetroSafe's key project team participant(s) attend kick-off meeting.



Completion Criteria:

- Project kickoff meeting completed.

4.20.2 Contract Design Review (CDR)

4.20.2.1 Review Contract Design

Motorola Responsibilities:

- Conduct detailed design review with MetroSafe project team.
- Present and review in detail the proposed design including, but not limited to, system description, system block diagram, floor/rack-up drawings, equipment list, Statement of Work, demarcation points, implementation schedule, and Acceptance Test Plans.
- Document/note any changes from original design.
- Present, review in detail, and agree on any proposed changes.

NOTE: See Change Order section below for more details on Change Order process.

Customer Responsibilities:

- Provide local meeting place.
- MetroSafe's key project team participants attend the meeting.
- Review in detail with Motorola the proposed design.
- Advise of any needed changes to original design.

Completion Criteria:

- ALL mutually agreed design changes have been captured, updated, and presented in appropriate design documentation.
- The system design is "frozen" in preparation for subsequent project phases such as Order Processing and Manufacturing.
- Any applicable Change Order(s) is executed in accordance with all material changes resulting from the Design Review to the contract.

Design Approval (Milestone)

- Motorola and MetroSafe approve the event by signing a Design Review milestone completion certificate.

4.20.3 Order Processing

4.20.3.1 Process Equipment List

Motorola Responsibilities:

- Process final equipment list(s) via Motorola Customer Order Fulfillment (COF) system.
- Appropriate orders are submitted to manufacturing and applicable 3rd party vendor for processing.

Customer Responsibilities:

- Provide local shipping location.
- Complete and provide Tax Certificate information verifying tax status of shipping location.

Completion Criteria:

- Motorola Factory Orders have been successfully provided and submitted for processing.

4.20.4 Manufacturing and Staging

4.20.4.1 Manufacture and Procure Fixed Network Equipment

Motorola Responsibilities:

- Manufacture the Fixed Network Equipment (FNE) per final design.
- Procure any third-party equipment per final design.

Customer Responsibilities:

- None.

Completion Criteria:

- All required equipment have been shipped and received in the field (customer-provided address) and Motorola Staging facility (Schaumburg, IL).

4.20.4.2 Ship to Staging (Milestone)

- Ship all equipment needed for staging to Motorola's factory staging facility in Schaumburg, Illinois.

4.20.4.3 Stage System

Staging of equipment including backhaul network will take place at Motorola Customer Center for Systems Integration (CCSi) facility in Schaumburg, IL.

Motorola Responsibilities:

- Set up, rack, and cable the system equipment per the approved rack and floor diagrams on a site-by-site basis, as it will be configured in the field.
- Exception: Non-staged equipment, such as spares, shall be shipped direct to the field (customer-provided local address).
- Cut and label cables according to the approved CDR documentation.
- Power up, program, and test all staged equipment.
- Perform system burn-in 24 hours a day during staging to isolate and capture any defects.
- Program sample Subscriber units with a test template.
- Inventory the equipment with serial numbers and installation references.
- Complete staging documentation.
- Review Factory Acceptance Test Plan (FATP) with MetroSafe.

Customer Responsibilities:

- Provide test subscribers (at least 5).
- Review and approve proposed FATP.

Completion Criteria:

- System staged and ready for FATP with MetroSafe.



4.20.4.4 Perform Factory Acceptance Test Procedures (FATP)

Motorola Responsibilities:

- Successfully demonstrate and document each FATP test to MetroSafe.
- Document, correct, and re-test all FATP deviations, anomalies, and failures.
- Replace any defective components.

Customer Responsibilities:

- Approve FATP.
- Witness and participate in FATP.

Completion Criteria:

- FATP has been completed successfully, all issues corrected, and system is ready for installation.

4.20.4.5 CCSi Ship Acceptance (Milestone)

- Motorola and MetroSafe approve the event by signing FATP.

4.20.5 Site Development

Customer responsibility

4.21 EQUIPMENT INSTALLATION

4.21.1 Bardstown Road Tower Site

Motorola Responsibilities:

Site Engineering

- Prepare site construction drawings, showing the layout of various new and existing site components.
- Prepare record drawings of the site showing the as-built information.
- Perform Limited National Environmental Policy Act (NEPA) Threshold Screening, including limited literature and records search and brief reporting, as necessary to identify sensitive natural and cultural features referenced in 47 Code of Federal Regulations (CFR) Chapter 1, subsection 1.1307 that may be potentially impacted by the proposed construction activity. This does not include the additional field investigations to document site conditions if it is determined that the proposed communication facility “may have a significant environmental impact” and thus require additional documentation, submittals, or work.
- Perform a structural engineering analysis for antenna support structure to support the proposed antenna system. If the tower structure fails the analysis, the cost of any site relocation or modifications to the tower required to support the antenna system will be the responsibility of Louisville. NOTE: This task does not include mapping, structural measurement survey, materials testing, geotechnical investigation, and/or other field investigation to acquire the data. If applicable, these tasks will be noted separately in the SOW.
- Provide tower climbing and tower mapping services for towers up to 350 feet to collect information about structural members and existing equipment.
- Conduct dispersive wave testing of foundations for a three legged self-supported tower to determine their structural details for analysis when tower drawings are not available.

- Preparation, submission and tracking of application for local permit fees (zoning, electrical, building etc.) and procurement of information necessary for filing.

New Antenna and Transmission Line Installations

- Install 6 antenna(s) for the RF system.
- Supply and install 6 6-foot side arm(s) for antenna mounts.
- Supply and install up to 2080' of 1 ¼" new transmission lines
- Perform sweep tests on transmission lines.
- Supply and install 1 ground buss bar at the bottom of the antenna support structure for grounding RF cables before they make horizontal transition

Removal of existing Antenna's, Microwave Dishes, and Ice Bridge. Tower Lighting replacement

- Provide and install a new medium strobe, E1 LED tower lighting system and remove the existing system
- Remove 15 antennas, 4 microwave dishes and all related transmission lines. Including the portion of lines inside the main building and dispose of the material
- Remove a second story ice bridge including the crane rental. Disassemble the ice bridge and dispose the material
- Seal old building cable entry port. Does not include re-bricking the opening

Customer Responsibilities:

- Maintain existing access road in order to provide clear and stable entry to the site for heavy-duty construction vehicles. Sufficient space must be available at the site for these vehicles to manoeuvre.
- Provide support and entry facilities for the new cables going to the shelter (cable ladder/chaseway, entry ports, etc.) between the proposed equipment locations.

Completion Criteria:

- Motorola and MetroSafe approve Bardstown Road completed work or scope by signing and dating an Installation Completion milestone certificate.

4.21.2 Fern Creek Tower Site

Site Engineering

- Perform Limited National Environmental Policy Act (NEPA) Threshold Screening, including limited literature and records search and brief reporting, as necessary to identify sensitive natural and cultural features referenced in 47 Code of Federal Regulations (CFR) Chapter 1, subsection 1.1307 that may be potentially impacted by the proposed construction activity. This does not include the additional field investigations to document site conditions if it is determined that the proposed communication facility “may have a significant environmental impact” and thus require additional documentation, submittals, or work.
- Perform a structural engineering analysis for antenna support structure to support the proposed antenna system. If the tower structure fails the analysis, the cost of any site relocation or modifications to the tower required to support the antenna system will be the responsibility of Louisville. NOTE: This task does not include mapping, structural measurement survey, materials testing, geotechnical investigation, and/or other field investigation to acquire the data. If applicable, these tasks will be noted separately in the SOW.
- Provide tower climbing and tower mapping services for towers up to 350 feet to collect information about structural members and existing equipment.

- Conduct dispersive wave testing of foundations for a three legged self-supported tower to determine their structural details for analysis when tower drawings are not available.
- Preparation, submission and tracking of application for local permitting and procurement of information necessary for filing.

New Antenna and Transmission Line Installations

- Install 1 VHF antenna for the VHF system.
- Supply and install 1 6-foot side arm(s) for antenna mount.
- Supply and install up to 300' of 7/8" new transmission line
- Perform sweep tests on transmission lines.

Customer Responsibilities:

- Maintain existing access road in order to provide clear and stable entry to the site for heavy-duty construction vehicles. Sufficient space must be available at the site for these vehicles to manoeuvre.
- Provide support and entry facilities for the new cables going to the shelter (cable ladder/chaseway, entry ports, etc.) between the proposed equipment locations.

Completion Criteria:

- Motorola and MetroSafe approve completed work or scope by signing and dating an Installation Completion milestone certificate

4.21.3 Old Mitchell Hill Tower Site

Site Engineering

- Preparation, submission and tracking of application for local permitting and procurement of information necessary for filing.

DC Power Plant Installation

- Deliver and install DC Power Plant (1 rack)
- Perform final DC power plant and battery testing prior to connecting equipment.

Customer Responsibilities:

- Install 25 amp circuit breaker in existing electric panel
- Install electrical wiring and conduit from circuit breaker to DC Power Plant

Completion Criteria:

- Motorola and MetroSafe approve completed work or scope by signing and dating an Installation Completion milestone certificate

4.21.4 Microwave Backhaul Network

Install locations: Plainfield and Belleville RF Sites

- FCC Licensing Services (i.e. coordination, filing, fees).
- Conduct site path walks to take “visual” view of proposed path to observe any possible path obstruction/issues.
- Generate and provide Paper Path Studies.

- Perform analysis of survey data and documentation and make any needed changes to the backhaul design based on information gathered in the field.
- Provide supervision of any required resolution to connectivity issues, interface issues, or quality issues throughout the implementation process.
- Installation of microwave antennas, transmission lines, fixed equipment, racks, battery backup and ancillary equipment and hardware required to deliver Ethernet for multi-site simulcast system.
- Install backhaul equipment in the customer provided equipment room floor space and antenna heights determined during path studies and approved by tower owner.
- Protect the cabling by providing and installing a bulkhead lightning surge protector.
- Perform final link verification with Customer prior to connecting the radio system.
- Provide full deployment documentation of Microwave link system including baseline receive levels, IP addresses, frequency's, antenna bearings, antenna sweeps and significant documentation upon completion of microwave network deployment.
- Remove the two existing Microwave dishes, waveguide, and equipment at Barrett. Leave equipment at site for Customer to dispose.

Customer Responsibilities:

- Provide site access as needed for Motorola personnel and subcontractors to complete equipment installations
- Secure site lease/ownership, zoning, permits, regulatory approvals, easements, and 120 VAC power source.
- Provide necessary space for installation of the new backhaul equipment inside existing shelters/equipment rooms and on the tower.
- Inspect and approve all equipment installations.
- Dispose of removed microwave equipment from Barrett.

Assumptions

- 2nd frequency is available for commissioning.

Completion Criteria:

- Motorola and MetroSafe approve installation of Microwave Equipment by signing and dating an Installation Completion milestone certificate.

4.21.5 Fixed Network Master Core/Prime/RF Equipment

Work described in this section shall be performed at the Master core, Prime, and RF sites.

Motorola Responsibilities:

- Inspect and inventory all racked equipment, cables, and other Motorola provided equipment.
- Provide any needed guidance with equipment installations being performed by Customer.
- Furnish and install all necessary cables (i.e. power, data) within and between each rack / cabinet for system interconnection:
- Power-up, program, test, and prepare radio system for acceptance testing

Customer Responsibilities:

- Provide secure storage for the Motorola-provided equipment, at a location central to the site. Motorola coordinates the receipt of the equipment with MetroSafe's designated contact, and inventory all equipment.
- Deliver and install the proposed equipment at each site per final design documents.

- Includes replacing the 15 STR stations with GTRs
- Provide and install Ethernet cable between UPTT servers and CEN.
- Properly install all equipment per R56 installation guidelines.
- Relocate existing equipment if necessary to make room for new equipment.
- Relocate/remove existing decommissioned equipment.

Completion Criteria:

- Motorola and MetroSafe approve installation of Core/Prime/RF Equipment by signing and dating an Installation Completion milestone certificate (per location).

4.21.6 Console Installation

Work described in this section shall be performed at the Main (44 MCC 7500 positions) and back-up (20 MCC 7100 console applications) PSAPs.

Motorola Responsibilities:

- Inspect and inventory all racked equipment, cables, and other Motorola provided equipment.
- Provide any needed guidance with equipment installations being performed by Customer.
- Power-up, program, test, and prepare console system for acceptance testing with Customer.

Customer Responsibilities:

- Provide secure storage for the Motorola-provided equipment, at a location central to the site. Motorola coordinates the receipt of the equipment with MetroSafe’s designated contact, and inventory all equipment.
- Pick-up, deliver and install the proposed console equipment per final design documents.
- Properly install all equipment per R56 installation guidelines.
- Install and connect all necessary cables within and between each racked equipment / consoles for system interconnection.
- Supply LAN cables between consoles and equipment room (two per Console).
- Provide computers for Motorola-provided MCC 7100 console applications (see System Description for Hardware requirements).
- Provide adequate floor space for new back room equipment.
- Relocate existing equipment if necessary to make room for new equipment.
- Inspect and approve all equipment installations.
- Relocate/remove existing decommissioned equipment.

Completion Criteria:

- Motorola and MetroSafe approve installation of Console Equipment by signing and dating an Installation Completion milestone certificate (per location).

4.21.7 RF Logging Equipment

Work described in this section shall be performed at the MetroSafe and back-up PSAPs.

Motorola/NICE Responsibilities:

- Stage NICE logging equipment to validate and test product operation prior to field installation.
- NICE Systems will provide qualified staff to manage, advise, implement and configure the application software according to the defined scope of the project in staging and in the field.
- Pick-up, deliver and install the NICE logging equipment
- NICE Systems will provide onsite support during the commissioning and testing of the system.

- Develop and administer the Installation Test Procedure (ITP) for verifying proper operation of the logging recorder.

NOTE: ITP is provided by NICE.

- Configure NICE Recorder for final integration.

Customer Responsibilities:

- Provide or coordinate access to the site, as necessary.
- Provide all required documentation and information for programming of the logging equipment prior to staging and installation.
- Provide a dedicated operational analog phone line jack to the back of the system cabinet for remote diagnostics.
- Complete the attached NICE Remote Access Consent Form (Appendix A).

Completion Criteria:

- Motorola and MetroSafe approve installation of Logging Equipment by signing and dating an Installation Completion milestone certificate.

4.21.8 Fire Station Alerting (FSA)

Work described in this section shall be performed at 28 Fire Stations.

Motorola/DCR Engineering Responsibilities:

- Inspect and inventory all racked equipment, cables, and other Motorola provided equipment.
- Provide any needed guidance with equipment installations being performed by Customer.
- DCR Engineering:
 - MACH Alert (FSA) staging, optimization, training (installer and end –user) and acceptance testing.
- Staging of proposed equipment at DCR Engineering facility in Florida
- Provide field installed equipment cables.
- Provide training as part of the project to the Customer and Customer’s electrical contractor on installation of the Fire Station Controller.
- Power-up, program, test, and prepare console system for acceptance testing with Customer.

Customer Responsibilities:

- Provide secure storage for the Motorola/DCR Engineering provided equipment, at a location central to the sites. Motorola coordinates the receipt of the equipment with MetroSafe’s designated contact, and inventory all equipment.
- Pick-up, deliver and install the proposed FSA equipment per final design documents.
- Properly install all equipment per R56 installation guidelines.
- Equipment installations:
 - FSA server and Alerting Interface Controller (AIC) are to be installed in an existing rack located at the main PSAP.
 - The NEMA-1 wall-mounted, enclosed Station Controller’s (see System Description) will be installed at 28 Fire Stations.
- Relocate existing XTL radio from current FSA (to be decommissioned) enclosure to the new Mach Alert enclosure.
- Provide an interface to Customer’s Computer Aided Dispatch (CAD) system:
 - CAD compliant interface to the MFD-P V7.31 specification with an agreed subset of the full set of defined messages.

- Provide connectivity between the CAD system and the FSA system via a standard RS-232C serial electrical interface employing the ASCII protocol defined in the specification.
- Install and connect all necessary cables within and between each racked equipment for system interconnection.
- Provide adequate floor space for new back room equipment.
- Relocate existing equipment if necessary to make room for new equipment.
- Inspect and approve all equipment installations.
- Relocate/remove existing decommissioned equipment.

Assumptions

- Re-use existing antenna and lines at each of the 28 fire stations.
- Additional assumptions listed in System Description.

Completion Criteria:

- Motorola and MetroSafe approve installation of FSA by signing and dating an Installation Completion milestone certificate (per Fire Station).

4.21.9 WAVE Application

Motorola Responsibilities:

- Install WAVE server hardware.
- Program and optimize server for final testing with programmed clients.
- Provide end user training.

Customer Responsibilities:

- Provide end user client.
- Load WAVE application on each client.

Completion Criteria:

- Motorola and MetroSafe approve installation of WAVE by signing and dating an Installation Completion milestone certificate.

4.21.10 System Installation Acceptance (Milestone)

- All equipment installations are completed and accepted by MetroSafe.
- Motorola and MetroSafe approve all equipment installs by signing and dating a System Installation Completion milestone certificate.

4.21.11 System Optimization

4.21.11.1 Optimize System FNE

Motorola Responsibilities:

- Verify that all equipment is operating properly and that all equipment levels are set correctly.
- Check forward and reflected power for all radio equipment, after connection to the antenna systems, to verify that power is within tolerances.
- Verify communication interfaces between devices for proper operation.

- Test features and functionality are in accordance with manufacturers' specifications and that they comply with the final approved configuration.
- Test and optimize the analog conventional simulcast system.

Customer Responsibilities:

- Upgrade the existing 312 GTR stations.
- Provide access/escort to the sites.
- Provide required radio ID and alias information to enable alias database setup for interface to console.

Completion Criteria:

- System FNE optimization is complete.

4.21.11.2 Optimization Complete

- System optimization is completed. Motorola and MetroSafe agree that the equipment is ready for acceptance testing.

4.21.12 Training

System Technical Training courses with this proposal will be conducted at Customer-provided facility or on-line. See Section 4.1.4 of this SOW for course descriptions and requirements.

4.21.12.1 Perform Training

Motorola Responsibilities:

- Finalize training schedules with MetroSafe purchased as part of this project.
- Provide student training materials.
- Conduct the training classes outlined in the Training Plan.

Customer Responsibilities:

- Provide adequately sized training room for proposed on-site training classes.
- Coordinate required student attendance at the scheduled class and time.
- Comply with the prerequisites identified in the Training Plan.

Completion Criteria:

- All training classes completed.

4.21.12.2 Training Complete

- All training classes completed.
- Motorola and MetroSafe approve the event by signing and dating a Training Completion milestone certificate.

4.21.13 Functional Acceptance Testing



4.21.13.1 Perform On-Site Acceptance Testing

Motorola Responsibilities:

- Supply minimum two (2) copies of the test plan.
- Conduct Site Acceptance Test Plan as approved at the design review.
- Test individual components of the system, to verify compliance to the equipment specifications.
- Repeat any failed test(s) once responsible party(ies) have taken corrective action(s).
- Prepare documentation of component tests to be delivered as part of the final documentation package.
- Record test results in test plan.

Customer Responsibilities:

- Witness and participate in acceptance tests.
- Record test results in test plan.

Completion Criteria:

- Successful completion of equipment testing.

4.21.13.2 Perform System Functional Testing

Motorola Responsibilities:

- Conduct System Acceptance Test Plan as approved at the design review.
- Supply minimum two (2) copies of the test plan.
- Repeat any failed test(s) once responsible party(ies) have taken corrective action(s).
- Prepare documentation of component tests to be delivered as part of the final documentation package.
- Record test results in test plan.

Customer Responsibilities:

- Witness and participate in acceptance tests.
- Record test results in test plan.

Completion Criteria:

- Successful completion of System Acceptance Test Plan.

4.21.14 Finalize

4.21.14.1 Cutover

Motorola Responsibilities:

- Motorola will present a preliminary cutover plan for MetroSafe's approval:
 - Plan shall cover proposed cutover timeline, procedures, user group migration, and fall back plan.
- During cutover, follow the written plan and implement the defined contingencies, as required, with little or no impact on the existing system and/or customer operations.
- Complete all required/proposed training plans prior to cutover.
- Coordinate with MetroSafe to ensuring all subscribers planned for cutover are activated in the system.

Customer Responsibilities:

- Attend cutover meeting and approve the cutover plan.
- Notify the user group(s) affected by the cutover (date and time).
- Conduct a roll call of all users working during the cutover, in an organized and methodical manner.
- Ensure that all subscriber users are trained.

Completion Criteria:

- Successful migration from the old system to the new system.

4.21.14.2 Transition to Service/Project Transition Certificate

Motorola Responsibilities:

- Review the items necessary for transitioning the project to warranty support and service.
- Provide a Customer Support Plan detailing the warranty and post-warranty support, if applicable, associated with the Contract equipment.
- Provide additional information regarding any applicable post-warranty support, included in the Warranty/Post-Warranty section of this document.

Customer Responsibilities:

- Participate in the Transition Service/Project Transition Certificate (PTC) process.

Completion Criteria:

- All service information has been delivered and approved by MetroSafe.

4.21.14.3 As-Built Documentation

At the completion of the installation phase Motorola will provide complete as-built documentation to include the following:

- Inventory of equipment provided to include quantity, model, and serial numbers.
- Any applicable final as-built construction drawings.
- System and rack-up diagrams.
- Successfully completed, signed, and dated acceptance test plans.

4.21.14.4 Final System Acceptance (Milestone)

Completion Criteria:

- All contracted services have been delivered and approved by MetroSafe.
- Motorola and MetroSafe approve Final Acceptance by signing a milestone completion certificate.

4.21.15 Change Orders

Either Party may request changes within the general scope of the award contract agreement. If a requested change causes an increase or decrease in the cost or time required to perform this Agreement, the Parties will agree to an equitable adjustment of the Contract Price, Implementation schedule, or both, and will reflect the adjustment in a change order. Neither Party is obligated to perform requested changes unless both Parties execute a written, jointly signed change order.

This page intentionally left blank.



4.22 APPENDIX A – NICE REMOTE ACCESS APPROVAL FORM

Motorola Solutions, Inc. and NICE Systems currently support deployed NICE IP loggers and replay stations in Motorola ASTRO®25 radio networks. The NICE IP Loggers, Scenario Replay or Inform replay stations are an integrated solution comprised of NICE proprietary software running on a Motorola hardware platform.

Motorola's direct engagement of NICE Systems for support of the Loggers, Scenario Replay or Inform replay stations is essential due to the proprietary nature of the software. To efficiently and effectively manage the support of these devices, as well as future deployments, Motorola is requesting NICE Systems Support Center in Denver Colorado have remote access to these devices.

To enable NICE Systems to remotely diagnosis the NICE IP Loggers, Scenario Replay or Inform replay stations, Motorola requires network monitoring of your ASTRO®25 radio network which provides the network connection. Network monitoring is a service provided by Motorola's System Support Center.

Motorola has evaluated the safeguards, such as personnel and IT, that NICE Systems has in place regarding their support operation in Denver Colorado for access into the ASTRO®25 radio systems as well as the steps Motorola has put in place for the VPN connection that NICE Systems will use to access the Motorola System Support Center network. It is Motorola's judgment that NICE Systems meets or exceeds Motorola's security criteria and as such Motorola's recommendation is that you give your consent allowing NICE Systems to conduct remote connectivity support of the IP Loggers, Scenario Replay or Inform replay stations deployed on the ASTRO®25 radio systems.

By giving your consent NICE Systems can remotely diagnose the performance of the NICE Logging recorder, Scenario Replay or Inform replay stations providing your ASTRO®25 radio.

System Information:

Company Name _____

System ID _____

IP Address for:

MCC 7500 IP Logging Recorder(s) _____

Archiving Interface Server (AIS) _____

Playback Workstation _____



I give consent for NICE Systems to have remote access into Motorola ASTRO®25 radio system.

Printed Name _____

Authorized Signature _____

Date _____

I do not give consent for NICE Systems to have remote access into Motorola ASTRO® radio system.

Printed Name _____

Authorized Signature _____

Date _____

Motorola field representative:

Motorolan Printed Name _____

Motorolan authorized signature _____

Date _____

Check this box if you would like the Motorola System Support Center to change the MOTOSEC password account and have NICE create a local MOTOSEC admin password when accessing the logging system



4.1 TRAINING

4.1.1 Overview

Motorola Solutions understands that the successful implementation and use of your communications system depends on effective training. We have developed a training proposal for the Louisville / Jefferson County MetroSafe Communication Migration (“MetroSafe”) to ensure a comprehensive understanding of your proposed system and all user equipment. We are leveraging over 75 years of training experience working with customers just like you to provide recommendations for your consideration. The training proposal detailed in the following pages incorporates customer feedback coupled with a best practices systematic approach to produce effective course delivery and content.

Our commitment to MetroSafe is to provide unsurpassed services that ensure the equipment operates efficiently for the life of the system, and in doing so, directly train your personnel to acquire a level of knowledge to utilize the system at its maximum potential.

MetroSafe personnel will gain in-depth understanding of the power of your new system through education and proficient daily use. Our high-quality training focuses attention on student needs. Training is complemented by our detailed documentation and available continuing education program.

We will collaborate with MetroSafe to develop a final customized training plan that fits your needs and assures that System Administrators, Maintenance Technicians and End Users are skilled in using your new system.

4.1.2 Training Approach

Our training solution delivers a combination of online training and field based instructor led training at MetroSafe locations using the operational equipment and classrooms. Motorola Solutions will employ knowledgeable and experienced instructors, well-designed courseware and integrated lab activities.

Training is based upon several key criteria:

- Course design is driven by an analysis of student needs and focuses on how-to rather than theory.
- Learning objectives are based upon what students need to accomplish on the job and focus on specific applications or components.
- Hands-on lab opportunities using MetroSafe-specific job aids are incorporated into training to maximize the transfer of skills and the retention/reuse of information.

Our instructors bring invaluable experience and first-hand knowledge of public safety systems into their training approach. This experience and knowledge provides them a better understanding of and insight into the practical aspects of the role of MetroSafe Managers, Technicians and End Users. Each has a proven ability to communicate with novice as well as expert personnel.





4.1.3 Courses Proposed

Motorola Solutions has identified the following course(s) that are necessary to achieve the training goals for MetroSafe. Course description files for the recommended courses are provided in the matrix below and/or in the training appendix. Class delivery for instructor-led courses in the field will be tailored for your system and features.

Specifically, our proposed training plan addresses the following categories as identified in your request for proposal:

- System Administrators
- Maintenance Technicians

It is recommended that students bring their laptop computers for all System Administrator and Technician classes.



4.1.3.1 System Technical Training

Course	Target Audience	No. of Sessions	Duration (days)	Location	Date	No. of Attendees
ASTRO 25 IV&D System Networking (Instructor-led)	System Administrators & Technicians	1	5	Louisville, KY	Prior to remaining classes	10
<p>Course Synopsis:</p> <p>This course provides the technician with the necessary networking information required for understanding the Network Transport subsystem components installed in an ASTRO 25 IV&D communications system. The course includes familiarization with basic networking concepts and the networking components deployed throughout the system.</p> <p>Note: Important standalone equipment requirements listed in the course description needed for this class to come out of spares kit, if customer purchased spares, or from other source. There are equipment requirements listed in the course description that are needed for this class.</p>						
ASTRO 25 IV&D with M Core System Overview (Self-paced; Online) Prerequisite #1	System Administrators & Technicians	1	4 hours	Self Paced Online	Prior to Prerequisite 2	10
<p>Course Synopsis:</p> <p>ASTRO® 25 IV&D Trunking with M Core System Overview self-paced course is the starting point of all ASTRO 25 IV&D Trunking with M Core systems. In order to take other classes, students are required to complete this course and obtain a passing score on the corresponding test. It presents a high-level description of the system's call flow capabilities, components, features and benefits.</p>						
ASTRO 25 IV&D Introduction to Radio System Administration (Self-paced; Online) Prerequisite #2	System Administrators & Technicians	1	10 hours	Self Paced Online	Prior to Radio System Administrator & other classes below	10
<p>Course Synopsis:</p> <p>This virtual, interactive course provides a high-level overview of the Motorola Radio System Management applications through recorded demonstrations of common system tasks.</p>						
ASTRO 25 IV&D Radio System Administrator Workshop (Instructor-led)	System Administrators	1	5	Louisville, KY	Prior to Managing the System	10



Course	Target Audience	No. of Sessions	Duration (days)	Location	Date	No. of Attendees
<p>Course Synopsis:</p> <p>This workshop covers administrator functions for an ASTRO 25 Integrated Voice and Data (IV&D) System. Learning activities in this course focus on how to use the different ASTRO 25 IV&D System Management applications. Participants will be provided with an opportunity to discuss how to structure their organization and personnel for optimal ASTRO 25 IV&D system use.</p>						
ASTRO 25 IV&D M Core Workshop (Instructor-led)	M Core Master Site Technicians	1	5	Louisville, KY	Prior to maintaining	10
<p>Course Synopsis:</p> <p>The ASTRO 25 IV&D with M Core course teaches advanced troubleshooting skills and best practices for the Trunked Large Systems. The course also focuses on gathering and analyzing system information to implement appropriate action(s) that return a system to full operational status.</p>						
ASTRO 25 IV&D GTR 8000 Repeater Site & ASTRO 25 IP Based Digital Simulcast Workshop (Instructor-led)	GTR8000 Site & IP Simulcast Technicians	1	5	Louisville, KY	Prior to maintaining	10
<p>GTR8000 Course Synopsis:</p> <p>This workshop describes the components in the ASTRO 25 IV&D System Repeater Site with GTR 8000 expandable site subsystem. This course also presents how the GTR 8000 expandable site subsystem operates and explains the tools and methods available for troubleshooting components within the subsystem.</p> <p>IP Based Digital Simulcast Course Synopsis:</p> <p>The ASTRO 25 IV&D IP Based Digital Simulcast workshop provides an understanding of the components that comprise the ASTRO 25 IV&D IP Simulcast subsystem, and how they operate in conjunction with each other. The workshop also explains the tools and methods available for troubleshooting components within the IP Based Simulcast subsystem.</p>						
MCC7000 Series Dispatch Consoles Overview (Self-paced; On-line)	Console Technicians	1	1 hour	Self Paced Online	Prior to maintaining	10



Course	Target Audience	No. of Sessions	Duration (days)	Location	Date	No. of Attendees
<p>Course Synopsis: This course provides an overview of the MCC 7000 series of Dispatch Consoles. It includes a description of the features, illustrations of subsystem architecture options, descriptions of subsystem components, and illustrations of signal flow and call processing.</p>						
MCC 7000 Series Dispatch Consoles Workshop (Includes MCC7500 Dispatch Consoles) (Instructor-led)	Console Technicians	1	4	Louisville, KY	Prior to maintaining	10
<p>Course Synopsis: This course familiarizes participants in installation, configuration, management and repair of MCC 7000 Series IP dispatch consoles, Archiving Interface Servers, AUX I/O servers, and Conventional Channel Gateways. The focus is on a detailed discussion of console hardware and hands-on activities with the installation and configuration of the MCC 7000 Series IP dispatch consoles.</p>						



This page intentionally left blank.



4.1.4 Course Descriptions

Course descriptions follow:



This page intentionally left blank.





ASTRO 25 IV&D with M Core System Overview ACS713200-E

Delivery Method

OLT = Online Training

Duration

4 hours

Target Audience

System Managers, Technical System Managers, System Technicians, and Application Users.

Course Overview

ASTRO® 25 IV&D Trunking with M Core System Overview self-paced course is the starting point of all ASTRO 25 IV&D Trunking with M Core systems. In order to take other classes, students are required to complete this course and obtain a passing score on the corresponding test. It presents a high-level description of the system's call flow capabilities, components, features and benefits.

Prerequisites

Completion of the following courses or equivalent knowledge:

- Bridging the Knowledge Gap for ASTRO 25 (ACT100 or ACT101)
- Networking Essentials in Communication Equipment (NST762)
- Advanced Networking in Motorola Communications Equipment (NWT003)

Learning Outcomes

After completing the course the participant will be able to:

- List and describe the ASTRO 25 IV&D Trunking with M Core system features and capabilities.
- Describe the ASTRO 25 with M Core system sites and their components.

- Describe the paths used for control, voice, and data in an ASTRO 25 IV&D Trunking with M Core system.
- List the servers and databases used in an ASTRO 25 IV&D Trunking with M Core system.
- Describe voice and data signal flows and mobility management.

Course Modules

Module 1: System Architecture

M-1 Core Architecture
 M-2 Core Architecture
 M-3 Core Architecture
 Common Server Architecture
 Scalability
 Module 1 Summary
 Module 1 Review Quiz

Module 2: System Features and Options

Flexible Site and Interzone Links
 Channel Partitioning
 Other Band Trunking
 Dynamic Dual Mode
 Fire Station Alerting
 Telephone Interconnect
 Digital Mutual Aid
 SmartX Site Converter
 ISSI.1 Network Gateway
 ISSI 8000 / CSSI 8000
 Dynamic System Resilience
 High Availability Data
 Radio Authentication
 Module 2 Summary
 Module 2 Review Quiz

Module 3: Zone Core Components

Direct Attached Storage Device
 Domain Controllers

Zone Controller
CSMS
PDG
GGSN
Network Management Components
Network Transport Components
Network Subnets
Servers & Databases
Module 3 Summary
Module 3 Review Quiz

Module 4: Remote Sites

GTR 8000 Expandable Site Hardware
Repeater Site
HPD Overlay
Simulcast Subsystem
Console Site
Conventional Channel Support
Site Statuses
Module 4 Summary
Module 4 Review Quiz

Module 5: Information Types & Paths

Control Information
Control Path
Voice Information
Voice Path
Data
Data Path
Data Path – HPD
Network Management Information
Network Management Path
Information Paths Routing
Routing Failure Scenarios
Module 5 Summary

Module 5 Review Quiz

Module 6: Voice & Data Processing

- Finding the Control Channel
- Affiliation & Registration
- Channel Request
- Authorizing the Call
- Assignment of Resources
- Busy Queue
- Call in Progress
- Finishing a Call
- Data Packets & Signal Flow
- Module 6 Summary
- Module 6 Review Quiz

Module 7: Mobility Management

- Affiliation & Registration
- Valid Sites for an Individual
- Valid Sites for a Talkgroup
- Site Access Denial Type
- Dynamic Site Assignment
- Continuous Assignment Updating
- De-registration
- Roaming
- Adjacent Sites
- RSSI Threshold
- Preferred Site
- Always Preferred Site
- Least Preferred Site
- Out of Range
- Inbound & Outbound
- Balanced Coverage
- Out-of-range Indications
- Scanning
- Priorities in Scan

Requested Site
Module 7 Summary
Module 7 Review Quiz
Final Assessment



ASTRO 25 IV&D M Core Workshop

ACS713103

Delivery Method

ILT = Instructor Led Training

Duration

5 days

Class size

Note: Class size varies by region.

Target Audience

M Core Master Site Technicians

Course Overview

The ASTRO 25 IV&D with M Core course teaches advanced troubleshooting skills and best practices for the Trunked Large Systems. The course also focuses on gathering and analyzing system information to implement appropriate action(s) that return a system to full operational status.

Prerequisites

Completion of the following courses or equivalent knowledge:

- Bridging the Knowledge Gap (ACT100 or ACT101)
- Networking Essentials in Communication Equipment (NST762)
- Advanced Networking in Motorola Communications Equipment (NWT003) or tailored five day field version

Take one of the following depending on system supporting:

- ASTRO 25 IV&D with M Core System Overview (ACS713200)
- ASTRO 25 IV&D Conventional with M Core Overview (ACS713420)
- ASTRO 25 IV&D Introduction to Radio System Management Applications (ACS713201)

Learning Outcomes

After completing the course the participant will be able to:

- Describe the ASTRO 25 System architecture
- Identify the functional and radio subsystems that comprise the ASTRO 25 System
- Explain and discuss call flow and data flow through Large System Core devices and their subsystems
- Perform recommended routine maintenance procedures for the ASTRO 25 Large System Core
- Utilize the troubleshooting tools to diagnose a fault and restore the Large System Core to the level of the Motorola-supported service strategy

Course Modules

Module 1: Course Introduction

Module 2: Overview of M Core Systems

Topic 2-1: System Review

Topic 2-2: Functional View – Call Processing (Control) Path

Topic 2-3: Functional View – Audio Path

Topic 2-4: Functional View – Data Path

Topic 2-5: Information Assurance High-Level Overview

Lab Activity

Module 3: System Troubleshooting Tools

Topic 3-1: Recommended Test Equipment

Topic 3-2: Troubleshooting Tools Overview

Topic 3-3: Detection and Monitoring Tools

Topic 3-4: Performance Management Tools

Module 4: Network Transport Subsystem

Topic 4-1: Network Transport Review

Topic 4-2: Core LAN Switch

Lab Activity

Topic 4-3: Routers

Topic 4-4: Cooperative WAN Routing (CWR)

Topic 4-5: Ethernet Site Links

Topic 4-6: Diagnostic Tools

Module 5: Virtual Management Server (VMS) System Servers

Topic 5-1: Servers Overview

Topic 5-2: Virtual Management Server (VMS)

Lab Activity

Module 6: Network Management and Zone Controller Applications

Topic 6-1: Zone Controller

Topic 6-2: Zone Controller Configuration

Topic 6-3: Network Management Overview

Topic 6-4: Network Management Servers

Topic 6-5: Network Management Databases

Topic 6-6: Network Management Clients

Topic 6-7: Network Management Applications

Lab Activity

- Module 7: Data Subsystem and Customer Enterprise Network (CEN) Interface
 - Topic 7-1: Integrated Voice and Data Description
 - Topic 7-2: Packet Data Gateway (PDG) Interface
 - Topic 7-3: "Global Packet Radio Service" Gateway Support Node (GGSN) Router
 - Topic 7-4: Customer Enterprise Network (CEN) Interface
 - Topic 7-5: Data Configuration
- Module 8: Routine Maintenance and System Troubleshooting
 - Topic 8-1: Recommended Routine Maintenance
 - Topic 8-2: Database Backups
 - Topic 8-3: Network Device Configuration Backup
 - Topic 8-4: Appendix A: Routine Maintenance Schedules
 - Topic 8-5: Troubleshooting Hard Failures
 - Topic 8-6: Troubleshooting Intermittent Failures
 - Topic 8-7: System-Level Reliability
 - Topic 8-8: Intrazone Reliability
 - Topic 8-9: Configuration Troubleshooting
 - Lab Activity
- Appendix A: Non-CSA Server Architecture
- Appendix B: MGED & AEB – Dispatch Subsystems
 - Topic B-1: Circuit-Based Dispatch Subsystem Overview
 - Topic B-2: Motorola Gold Elite Gateway (MGEG)
 - Topic B-3: Ambassador Electronics Bank (AEB)



ASTRO 25 IV&D Introduction to Radio System Management Applications ***ACS713201***

Delivery Method

OLT = Online Training

Duration

10 hours

Target Audience

System Managers, Technical System Managers, System Technicians, and other Application Users.

Course Overview

This virtual, interactive course provides a high-level overview of the Motorola Radio System Management applications through recorded demonstrations of common system tasks.

Prerequisites

Completion of the following courses or equivalent knowledge:

- Bridging the Knowledge Gap – Technicians (ACT100)

Required:

Take one of the following depending on system supporting:

- ASTRO® 25 IV&D with M Core System Overview (ACS713200)
- ASTRO® 25 IV&D Conventional with M Core Overview (ACS713420)
- ASTRO® 25 IV&D with L Core System Overview (ACS713430)

Learning Outcomes

After completing the course the participant will be able to:

- Describe the purpose of Network Management applications used in an ASTRO system
- Identify high-level capabilities of those Network Administrator applications
- Familiarize with common operations allowed by those Network Administrator applications

Course Modules

Module 1:

- System Profile
- Zone Profile
- ZoneWatch
- ATIA Log Viewer

Module 2:

- Unified Event Manager (UEM)
- Affiliation Display

Module 3:

- Radio Control Manager (RCM)
- Reports

Module 4:

- Provisioning Manager

Module 5:

- EMC Ionix Network Configuration Manager



ASTRO 25 IV&D Radio System Administrator Workshop ACS713102

Delivery Method

ILT = Instructor Led Training

Duration

5 days

Target Audience

System Administrators, Technical System Administrators, System Technicians and other Application Users.

The applications covered in this course only apply to customers with releases 7.4 or newer.

Course Overview

This workshop covers administrator functions for an ASTRO 25 Integrated Voice and Data (IV&D) System. Learning activities in this course focus on how to use the different ASTRO 25 IV&D System Management applications. Participants will be provided with an opportunity to discuss how to structure their organization and personnel for optimal ASTRO 25 IV&D system use.

Prerequisites

Completion of the following courses or equivalent knowledge:

- Bridging the Knowledge Gap – System Administrators (ACT101)
- Networking Essentials in Communication Equipment (NST762)
- Advanced Networking in Motorola Communications Equipment (NWT003) or tailored five day field version

Take one of the following depending on system supporting:

- ASTRO 25 IV&D with M Core System Overview (ACS712200)
- ASTRO 25 IV&D Conventional with M Core Overview (ACS712420)
- ASTRO 25 IV&D with L Core System Overview (ACS712430)
- ASTRO 25 IV&D Introduction to Radio System Management Applications (ACS712201)

Learning Outcomes

After completing the course the participant will be able to:

- Describe the relationship between radio programming, console administration and system management, and the impact of this relationship on system planning.
- List the network management tools applicable at each phase of the system life cycle.
- Identify the advantages and disadvantages of options available for the configuration of system infrastructure and user parameters.
- Use the report and real-time data to monitor performance and make adjustments necessary to maintain acceptable system performance levels.
- Explain the key factors that affect the planning of ASTRO 25 Radio Systems and create a Fleetmap.

Course Modules

Module 1: Course Introduction

Module 2: Basic Concepts of Radio System Administration

Topic 2-1: Why Did They Do it That Way?

Topic 2-2: Radio Programming vs. System Management

Topic 2-3: List of Management Applications

Module 3: Configuration

Topic 3-1: Configuration Process and Tools

Topic 3-2: Adding Radios and Talkgroups to the System

Topic 3-3: Editing Existing Records in PM

Topic 3-4: Setting System-Level Parameters

Topic 3-5: Creating Managers and Controlling Access

Topic 3-6: Managing Configurations with UNC

Topic 3-7: Configuring Sites and Channels with PM

Module 4: Operation and Optimization

Topic 4-1: License Sharing

Topic 4-2: Live Monitoring of the System

Topic 4-3: Report Generation

Topic 4-4: Network Maintenance Tools

Module 5: Communications Planning

Topic 5-1: Factors That Impact Communications System Planning

Topic 5-2: Fleetmapping

**Duration**

5 Days

Delivery Method

Instructor-led

Target Audience

Technical system managers, technicians, engineers

Course Synopsis

This course provides the technician with the necessary networking information required for understanding the Network Transport subsystem components installed in an ASTRO 25 IV&D communications system. The course includes familiarization with basic networking concepts and the networking components deployed throughout the system.

Required Pre-Work

None

Required Lab Equipment

Items required for a single lab position with two participants:

- One Motorola router (model number GGM8000, S2500, S6000 or S4000)
- One Hewlett Packard Procurve switch (model number 2610-24, 2626 or 2524)
- Two RJ-45 network cables
- One DB9 to DB9 null modem cable (connects PC to console connector on switch and router)
- One DB9 to RJ-45 null modem cable (only applies to the 2610 switches)
- A sufficient number of power cords and power strips
- One PC or laptop with a login account that has the authority to change the IP address, add a TFTP file transfer program (3CDAemon) and execute a TFTP file transfer.

NOTE: the total equipment required is dependant on the number of participants;
i.e. twelve participants would require six sets of equipment.

Recommended Prerequisites

None

Course Objectives

Upon Completion, the Participant Will Be Able To:

- Understand basic networking concepts
- Describe the various Transport network subsystem components
- Define the LAN topologies for each system
- Define the WAN topologies for each system
- Identify the expanse of Network Management across each system
- Discuss HP Switch, and Motorola Series Router configurations
- Describe and Perform the backup/restore procedures for the HP Switch and Motorola Series Routers in the ASTRO 25 system

Course Outline

- I. Basic Networking Concepts
 - A. Terminology and Acronyms
 - B. LANS and WANS
 - C. Basic Protocols
 - D. Network troubleshooting commands
- II. ASTRO 25 Network Transport Subsystem
 - A. Call Processing
 1. Block diagram description of how a call travels through the system
 2. Identification and isolation of the network components
 - B. Network Components
 1. HP Switches—description and location in the network
 - a) Menu-Driven Configuration
 - b) Web-Based Configuration
 2. Cooperative WAN Routing—description and location in the network
 3. Motorola Series Routers—description and location in the network
 - a) Command Line Interface Configuration
 - b) Menu-Driven Configuration
 - c) Web-Based Configuration
 4. Router Manager -- location and application identification
 - C. Network Concepts
 1. Identify the LAN portion(s) of the network
 2. Identify the LAN Protocols and describe where they are present in the network
 3. Identify the WAN portion(s) of the network
 4. Identify the WAN Protocols and describe where they are present in the network
 - D. Hands-On Practice
 1. Backup and Restore HP Switch Configurations
 2. Backup and Restore Motorola Series Router Configurations
 3. Create router boot configuration file

4. Flash routers with new operating system



GTR 8000 REPEATER SITE WORKSHOP

ACS713208

COURSE DESCRIPTION

ASTRO[®] 25 Integrated Voice & Data System Release 7.13 –
NOVEMBER 2012



MOTOROLA SOLUTIONS LEARNING



Delivery Method

ILT = Instructor Led Training

Duration

3 days

Target Audience

GTR 8000 Site Technicians

Course Overview

This workshop describes the components in the ASTRO 25 IV&D System Repeater Site with GTR 8000 expandable site subsystem. This course also presents how the GTR 8000 expandable site subsystem operates and explains the tools and methods available for troubleshooting components within the subsystem.

Prerequisites

Completion of the following courses or equivalent knowledge:

- Bridging the Knowledge Gap – Technicians (ACT100)
- Networking Essentials in Communication Equipment (NST762)
- Advanced Networking in Motorola Communications Equipment (NWT003)

Take one of the following depending on system supporting:

- ASTRO 25 IV&D with M Core System Overview (ACS713200)
- ASTRO 25 IV&D with L Core System Overview (ACS713430)

ASTRO 25 IV&D Introduction to Radio System Management Applications (ACS713201)

Learning Outcomes

After completing the course the participant will be able to:

- Describe the ASTRO 25 Repeater Site with GTR 8000 Expandable Site Subsystem configurations and components
- Identify the GCP 8000 Site Controller functions and configuration requirements
- Describe the connections and interfaces to the GCP 8000
- Diagnose and troubleshoot the GCP 8000



- Describe the functionality of the GTR 8000 Expandable Site Subsystem
- Configure and troubleshoot the ASTRO 25 Repeater Site with GTR 8000 Expandable Site Subsystem
- Configure and troubleshoot the Network Transport subsystem

Course Modules

Module 1: Course Introduction

Module 2: GTR 8000 Repeater Site

Topic 2-1: GTR 8000 Repeater Site Overview

Topic 2-2: Operational Modes

Topic 2-3: Site Configurations

Topic 2-4: Site Components

Topic 2-5: Time Synchronization and Frequency Reference

Test Your Understanding Exercise

Module 3: GCP 8000 Site Controller

Topic 3-1: GCP 8000 Overview

Topic 3-2: GCP 8000 Physical Description

Topic 3-3: GCP 8000 Configuration

Topic 3-4: GCP 8000 Diagnostics and Troubleshooting

Test Your Understanding Exercise

Module 4: GTR 8000 Expandable Site Subsystem

Topic 4-1: GTR 8000 Expandable Site Subsystem Overview

Topic 4-2: GTR 8000 Expandable Site Subsystem Theory of Operation

Topic 4-3: GTR 8000 Expandable Site Subsystem Configuration

Topic 4-4: GTR8000 Expandable Site Subsystem Diagnostics and Troubleshooting

Test Your Understanding Exercise

Module 5: Radio Frequency Distribution System (RFDS)

Topic 5-1: RFDS Overview

Topic 5-2: RFDS Physical Description

Topic 5-3: RFDS Configuration

Topic 5-4: RFDS Diagnostics and Troubleshooting

Test Your Understanding Exercise

Module 6: Network Transport Subsystem

Topic 6-1: Network Transport Subsystem Overview



Topic 6-2: Ethernet Switch Diagnostics and Troubleshooting

Topic 6-3: Site Gateways

Topic 6-4: Gateway Diagnostics and Troubleshooting

Test Your Understanding Exercise

Module 7: GTR 8000 Site Maintenance and Troubleshooting

Topic 7-1: Troubleshooting Tools

Topic 7-2: Troubleshooting Methodology

Topic 7-3: Troubleshooting Repeater Site Link

Topic 7-4: Motorola Support Centers



**IP BASED
DIGITAL SIMULCAST WORKSHOP
ACS713217**

Delivery Method

ILT = Instructor Led Training

Duration

3 days

Target Audience

Simulcast Site Technicians

Course Overview

The ASTRO 25 IV&D IP Based Digital Simulcast workshop provides an understanding of the components that comprise the ASTRO 25 IV&D IP Simulcast subsystem, and how they operate in conjunction with each other. The workshop also explains the tools and methods available for troubleshooting components within the IP Based Simulcast subsystem.

Prerequisites

Completion of the following courses or equivalent knowledge:

- Bridging the Knowledge Gap – Technicians (ACT100)
- Networking Essentials in Communication Equipment (NST762)
- Advanced Networking in Motorola Communications Equipment (NWT003)

Take one of the following depending on system supporting:

- ASTRO 25 IV&D with M Core System Overview (ACS713200)
- ASTRO 25 IV&D with L Core System Overview (ACS713430)

Learning Outcomes

After completing the course the participant will be able to:

- Recognize the flow of message and control data within an ASTRO 25 IV&D IP Digital Simulcast subsystem
- Identify the major components and connections within an ASTRO 25 IV&D IP Digital Simulcast subsystem prime and remote sites
- Recognize how calls are processed within an ASTRO 25 IV&D IP Digital Simulcast subsystem

- Perform maintenance and troubleshooting of select components in an ASTRO 25 IV&D IP Digital Simulcast subsystem

Course Modules

Module 1: Course Introduction

Module 2: Repeater Site

Topic 2-1: Simulcast Review

Topic 2-2: IP Simulcast with GTR 8000 Subsystem Overview

Topic 2-3: Site Configurations

Topic 2-4: IP Simulcast – Integrated Voice and Data

Module 3: GCP 8000 Site Controller

Topic 3-1: GCP 8000 Overview

Topic 3-2: GCP 8000 Physical Description

Topic 3-3: GCP 8000 Configuration

Topic 3-4: GCP 8000 Diagnostics and Troubleshooting

Module 4: GTR 8000 Comparator

Topic 4-1: GCM 8000 Overview

Topic 4-2: GCM 8000 Physical Description

Topic 4-3: GCM 8000 Configuration

Topic 4-4: GCM Diagnostics and Troubleshooting

Module 5: IP Simulcast Network

Topic 5-1: Ethernet LAN Switches

5-1.1: Ethernet Switch – Overview

5-1.2: Ethernet Switch – Physical Description

5-1.3: Ethernet Switch – Configuration

5-1.4: Ethernet Switch – Diagnostics and Troubleshooting

Topic 5-2: Prime Site Routers/Gateways

5-2.1: Prime Site Routers/Gateways – Overview

5-2.2: Prime Site Routers/Gateways – Physical Description

5-2.3: Prime Site Routers/Gateways – Configuration

5-2.4: Prime Site Routers/Gateways – Diagnostics and Troubleshooting

Topic 5-3: Remote Site Routers/Gateway

5-3.1: Remote Site Routers/Gateway – Overview

5-3.2: Remote Site Routers/Gateway – Physical Description

5-3.3: Remote Site Routers/Gateway – Configuration

5-3.4: Remote Site Routers/Gateway – Diagnostics and Troubleshooting

Module 6: TRAK 9100 Site Reference

Topic 6-1: TRAK 9100 Site Reference Overview

Topic 6-2: TRAK 9100 Site Reference Physical Description

Topic 6-3: TRAK 9100 Site Reference Installation and Configuration

Topic 6-4: TRAK 9100 Site Reference Diagnostics and Troubleshooting

Module 7: GTR 8000 Base Radio Subsystem

Topic 7-1: GTR 8000 Base Radio Subsystem Overview

Topic 7-2: GTR 8000 Base Radio Subsystem Physical Description

Topic 7-3: GTR 8000 Base Radio Subsystem Configuration

Topic 7-4: GTR 8000 Base Radio Subsystem Diagnostics and Troubleshooting

Module 8: IP Simulcast Subsystem Maintenance and Troubleshooting

Topic 8-1: Maintenance and Troubleshooting Overview

Topic 8-2: Troubleshooting Tools

Topic 8-3: Device Fault Management

Topic 8-4: Troubleshooting Process
Topic 8-5: Troubleshooting Site Links
Topic 8-6: Motorola Support Centers



MCC 7000 SERIES DISPATCH CONSOLES OVERVIEW

CON014

COURSE DESCRIPTION

NOVEMBER 2012

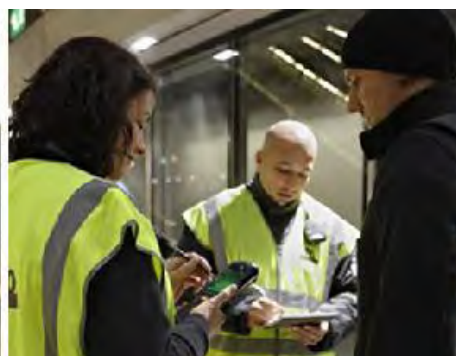

MOTOROLA SOLUTIONS LEARNING



Delivery Method

OLT = Online Training

Duration

1 hour

Target Audience

System Administrators, Console Technicians

Course Overview

This course provides an overview of the MCC 7000 series of Dispatch Consoles. It includes a description of the features, illustrations of subsystem architecture options, descriptions of subsystem components, and illustrations of signal flow and call processing.

Prerequisites

- Completion of the following courses or equivalent knowledge:
- Bridging the Knowledge Gap (ACT100-E or ACT101-E)
- Networking Essentials in Communication Equipment (NST762)
- Advanced Networking in Motorola Communications Equipment (NWT003)

Required

- Select the System Overview specific to your ASTRO 25 IV&D Core:
 - ASTRO 25 IV&D with M Core System Overview (ACS713200)
 - ASTRO 25 IV&D Conventional with M Core System Overview (ACS713420)
 - ASTRO 25 IV&D with L Core System Overview (ACS713430)
 - ASTRO 25 IV&D Conventional with K Core System Overview (ACS713400)
- ASTRO 25 IV&D Introduction to Radio System Management Applications (ACS713201)

Learning Outcomes

After completing the course the participant will be able to:

- Describe the features of MCC 7000 series of Dispatch Consoles.



- Explain the various system architectures for Dispatch Console subsystems.
- Describe system components in a Dispatch Console subsystem.
- Describe the steps in the signal flow of call processing from a Dispatch Console.

Course Modules

Module 1: Course Introduction

Module 2: Console Architectures

- Topic 2-1: Introduction
- Topic 2-2: Co-located Console Sites
- Topic 2-3: Remote Console Sites
- Topic 2-4: CENTRACOM Interoperability
- Topic 2-5: Dispatch Console Subsystem
- Topic 2-6: Conventional Configurations

Module 3: Console Subsystem Components

- Topic 3-1: Introduction
- Topic 3-2: Console Operator Position
- Topic 3-3: MCC 7500 with GPIOM
- Topic 3-4: MCC 7500 with Voice Processing Module (VPM)
- Topic 3-5: MCC 7100
- Topic 3-6: Logging System
- Topic 3-7: Console Alias Manager - MKM 7000
- Topic 3-8: Auxiliary I/O Server
- Topic 3-9: Conventional Channel Gateway
- Topic 3-10: Conventional Site Controller

Module 4: Console Features

- Topic 4-1: Capacity
- Topic 4-2: Example of Console Functions
- Topic 4-3: Administrator and Dispatcher Applications
- Topic 4-4: Over-the-Ethernet Keying (OTEK)

Module 5: Call Processing

- Topic 5-1: Introduction
- Topic 5-2: Link Op
- Topic 5-3: Call Request



Topic 5-4: Call Setup

Topic 5-5: Call Grant

Topic 5-6: Audio Routing

Topic 5-7: Call Continuation or Teardown



MCC 7000 SERIES DISPATCH CONSOLES WORKSHOP

CON012

COURSE DESCRIPTION

NOVEMBER 2012



MOTOROLA SOLUTIONS LEARNING



Delivery Method

ILT = Instructor Led Training

Duration

4 days

Target Audience

System Administrators, Console Technicians

Course Overview

This course familiarizes participants in installation, configuration, management and repair of MCC 7000 Series IP dispatch consoles, Archiving Interface Servers, AUX I/O servers, and Conventional Channel Gateways. The focus is on a detailed discussion of console hardware and hands-on activities with the installation and configuration of the MCC 7000 Series IP dispatch consoles.

Prerequisites

- Completion of the following courses or equivalent knowledge:
 - Bridging the Knowledge Gap (ACT100-E or ACT101-E)
 - Networking Essentials in Communication Equipment (NST762)
 - Advanced Networking in Motorola Communications Equipment (NWT003)

Required

- MCC 7000-Series Console Overview (CON014)
- ASTRO 25 IV&D with M Core System Overview (ACS713200)
- ASTRO 25 IV&D Introduction to Radio System Management Applications (ACS713201)

Learning Outcomes

After completing the course the participant will be able to:

- Install and configure the hardware and software components of the MCC 7000 Dispatch Console Subsystem
- Perform MCC 7000 Series site connectivity and bandwidth management
- Perform System Administrator functions using the Elite Administrator software



- Troubleshoot installation and configuration problems for the MCC 7000 Series Dispatch Consoles

Lab Requirements

- AIS
- AUX I/O servers
- Network Management Terminals at a ratio of 1 for every 4 students to ensure proper hands-on

Course Modules

Module 1: Course Introduction

Module 2: Dispatch Console Overview

Topic 2-1: Features

Topic 2-2: System Views

Topic 2-4: Call Processing

Module 3: Dispatch Console Hardware

Topic 3-1: Dispatch Console Configuration

Module 4: AUX I/Os

Topic 4-1: Auxiliary Inputs/Outputs (Aux I/Os)

Module 5: Conventional Communication

Topic 5-1: Conventional Communication

Module 6: Domain Controllers

Topic 6-1: Domain Controllers and Active Directory

Module 7: Administrator Functions

Topic 7-1: Editing Current Configurations

Topic 7-2: Setting Up Folders and Resources

Topic 7-3: Setting Up Auxiliary I/Os

Topic 7-4: Configuring Toolbars

Topic 7-5: Editing Preferences

Topic 7-6: Auto Starting the MCC 7500 Dispatch Console

Topic 7-7: Setting Up Inbound Event Display

Topic 7-8: MKM 7500 Console Alias Manager

Module 8: Troubleshooting

Topic 8-1: Troubleshooting with UEM

Topic 8-2: Troubleshooting MCC 7000 Series Components

Dispatch Operator Training Outline

1. Introduction to the *MACH Alert* Fire Station Alerting (FSA) System
2. Overall System Overview
 - 2.1. Dispatch Interface
 - 2.1.1. Automated CAD - Optional
 - 2.1.2. Manual Dispatch from FSA Server
 - 2.2. FSA Server
 - 2.2.1. Hardware
 - 2.2.2. Functionality
 - 2.3. Alerting Interface Controller(AIC)
 - 2.3.1. Hardware
 - 2.3.2. Functionality
 - 2.4. Station Controller (SC)
 - 2.4.1. Hardware
 - 2.4.2. Functionality
 - 2.5. Incident Display Boards (IDB) – Optional
 - 2.6. Station LED Lighting Controller – Optional
3. Dispatch Operator Interface
 - 3.1. Logging On
 - 3.2. Dispatch Position Screen
 - 3.2.1. Sending Alerts
 - 3.2.2. Icons and Status Indicators
 - 3.2.3. Dispatch Failure/Error Indicators
 - 3.3. Alarming and Alarm Page
 - 3.3.1. Common Alarms
 - 3.3.2. Dispatch Failure Alarms
 - 3.4. Checking Communication Links
 - 3.5. Performing Interrogations

- 3.6. Outdoor Speaker Controls
- 3.7. Operational Scenario Examples
- 3.8. Logging Out
- 4. FAQs

Troubleshooting & Maintenance Training Outline

1. Overall System Design
 - 1.1. Overview of the *MACH Alert* Fire Station Alerting (FSA) Solution
 - 1.2. How *MACH Alert* fits into the Communications Infrastructure
 - 1.3. Alerting Interface Controller (AIC)
 - 1.4. Station Controllers (SCs)
 - 1.5. FSA Server
 - 1.6. Network Design
 - 1.7. Overview of most common issues reported
 - 1.7.1. Single Station Alerting Issues
 - 1.7.2. Multiple Station Alerting Issues
 - 1.7.3. Computer Aided Dispatch (CAD) Failure – If applicable
 - 1.7.4. Communication Link Alarms
2. FSA Server
 - 2.1. CAD Interface – Optional
 - 2.2. FSA Server Failure
 - 2.3. Troubleshooting and Replacement
3. Overview of the Motorola ACE3600 RTU
 - 3.1. CPU Module
 - 3.1.1. Features
 - 3.1.2. Communication Ports
 - 3.1.3. LED Descriptions
 - 3.1.4. Troubleshooting and Replacement
 - 3.2. Power Supply/Charger Modules
 - 3.2.1. Features
 - 3.2.2. Battery Backup
 - 3.2.3. Input and Output Ports
 - 3.2.4. Connections

- 3.2.5. LED Descriptions
 - 3.2.6. Troubleshooting and Replacement
 - 3.3. Input/Output (I/O) Modules
 - 3.3.1. 32 Digital I/O Module
 - 3.3.2. Digital Input Connections
 - 3.3.3. Digital Output Connections
 - 3.3.4. Wiring Considerations
 - 3.3.5. LED Descriptions
 - 3.3.6. ACTIVE Module
 - 3.3.7. Troubleshooting and Replacement
 - 3.4. Motorola Radios
 - 3.4.1. Features
 - 3.4.2. LED Descriptions
 - 3.4.3. Troubleshooting and Replacement
- 4. Alerting Interface Controller (AIC) Panel
 - 4.1. Overview of components
 - 4.2. Review General Arrangement Drawings
 - 4.3. AIC Failure
 - 4.4. Troubleshooting and Replacement of Components
- 5. Station Controller (SC) Panel
 - 5.1. Overview of components
 - 5.2. Review General Arrangement Drawings
 - 5.3. Review Elementary Diagram Drawings
 - 5.4. Review Wiring Diagram Drawings
 - 5.5. Available Inputs and Functionality
 - 5.6. Available Outputs and Functionality
 - 5.7. SC Failure
 - 5.8. Troubleshooting and Replacement of Components
- 6. Incident Display Boards (IDB) - Optional
 - 6.1. Overview of components
 - 6.2. IDB Failure
 - 6.3. Troubleshooting and Replacement of Components
- 7. Station LED Lighting Controller - Optional

- 7.1. Overview of components
- 7.2. LED Lighting Controller Failure
- 7.3. Troubleshooting and Replacement of Components
- 8. FAQs

Field Installation Training Outline

- 1.1. General System Overview
- 1.2. DCR-Provided Equipment for *MACH Alert* FSA
 - 1.2.1. FSA Server Mechanical Design Concept
 - 1.2.2. The Alerting Interface Controller (AIC) Mechanical Design Concept
 - 1.2.3. The Station Controller (SC) Mechanical Design Concept
- 1.3. Warnings and Hazards
- 1.4. Installation Planning and Staging
- 1.5. Typical System Equipment and Interconnection
- 1.6. Installation Guidelines
 - 1.6.1. FSA Server
 - 1.6.2. Alerting Interface Controller
 - 1.6.3. Station Controller Panel
 - 1.6.3.1. Mounting Practices
 - 1.6.3.2. Clearance Requirements
 - 1.6.4. Lighting Controller - Optional
 - 1.6.5. Zone Selection Switches - Optional
 - 1.6.6. General PA System Requirements
 - 1.6.7. Audio Connections
 - 1.6.7.1. Inputs
 - 1.6.7.2. Outputs
 - 1.6.7.3. Zoning - Optional
 - 1.6.8. Inputs and Outputs
 - 1.6.9. Power Requirements
 - 1.6.10. IP Network Requirements
 - 1.6.11. RF Network Requirements (Antennas, Cabling, and Connections)
 - 1.6.12. Grounding

- 1.7. Side-by-side Installation of Station Controller(s)
- 1.8. FAQs

Louisville P25 Upgrade

ID	Task Name	Duration	Start	Finish	Predecessors	Resource Names	01	20	20	20	20	20	20	20	20	20	20					
							Jun	Jul	Aug	Sep	Oct	Nov	Dec	Jan	Feb	Mar	Apr	May	Jun	Jul	Aug	
1	Contract	10 days	Mon 8/3/15	Fri 8/14/15																		
2	Contract Award	0 days	Mon 8/3/15	Mon 8/3/15		Milestone																
3	Contract Administration	4 days	Mon 8/3/15	Thu 8/6/15	2	Motorola, Customer	8/3		8/6													
4	Project Kick - Off	1 day	Fri 8/14/15	Fri 8/14/15	3FS+5 days	Motorola, Customer	8/14		8/14													
5	Contract Design Review	2 days	Mon 9/14/15	Tue 9/15/15																		
6	Detailed Design Review	2 days	Mon 9/14/15	Tue 9/15/15	4FS+20 days	Motorola, Customer	9/14		9/15													
7	Design Review Approval	0 days	Tue 9/15/15	Tue 9/15/15	6	Milestone				9/15												
8	Order Processing	4 days	Wed 9/16/15	Mon 9/21/15																		
9	Process Equipment list	1 day	Wed 9/16/15	Wed 9/16/15	7	Motorola	9/16		9/16													
10	Order Bridged	0 days	Mon 9/21/15	Mon 9/21/15	9FS+3 days	Milestone					9/21											
11	Equipment Manufacturing	40 days	Tue 9/22/15	Mon 11/16/15																		
12	Manufacture/Procurement Equipment	40 days	Tue 9/22/15	Mon 11/16/15	10	Motorola	9/22															11/16
13	Manufacture Subscribers	25 days	Tue 9/22/15	Mon 10/26/15	10	Motorola	9/22															10/26
14	Orders shipped	0 days	Mon 10/26/15	Mon 10/26/15	13	Milestone																10/26
15	Staging	31 days	Thu 10/29/15	Thu 12/10/15																		
16	Receive and Inventory Equipment	2 days	Thu 10/29/15	Fri 10/30/15	14FS+2 days	Motorola	10/29															10/30
17	Stage System	20 days	Mon 11/2/15	Fri 11/27/15	16	Motorola	11/2															11/27
18	CCSI Stage/Ship Acceptance	0 days	Fri 11/27/15	Fri 11/27/15	17	Milestone																11/27

Project: Louisville P25 project schedul
Date: Sun 5/17/15

Task		Split		Manual Summary Rollup	
Critical Task		External Tasks		Manual Summary	
Milestone		Project Summary		Start-only	
Summary		Group By Summary		Finish-only	
Rolled Up Task		Inactive Milestone		External Tasks	
Rolled Up Critical Task		Inactive Summary		External Milestone	
Rolled Up Milestone		Manual Task		Progress	
Rolled Up Progress		Duration-only		Deadline	

Louisville P25 Upgrade

ID	Task Name	Duration	Start	Finish	Predecessors	Resource Names	01	20	20	20	20	20	20	20	20	20	20	
							Qtr 3, 2015	Qtr 3, 2015	Qtr 4, 2015	Qtr 1, 2016	Qtr 2, 2016	Qtr 3, 2016	Qtr 4, 2016	Qtr 1, 2017	Qtr 2, 2017	Qtr 3, 2017	Qtr 4, 2017	
19	Package/Ship Equipment to Field	5 days	Mon 11/30/15	Fri 12/4/15	18	Motorola												
20	Receive & Inventory Equipment in Field	1 day	Thu 12/10/15	Thu 12/10/15	19FS+3 days	Motorola												
21	Microwave Backhaul Design & Installation	107 days	Wed 9/23/15	Thu 2/18/16														
22	Microwave Path Study and Survey Reports	10 days	Wed 9/23/15	Tue 10/6/15	7FS+5 days	Motorola												
23	Path Studies Complete	0 days	Tue 10/6/15	Tue 10/6/15	22	Milestone												
24	Interference Analysis and Frequency Coordiantion	5 days	Wed 10/7/15	Tue 10/13/15	23	Motorola												
25	FCC Licensing	40 days	Wed 10/14/15	Tue 12/8/15	24	Motorola												
26	Manufacture & Staging	50 days	Wed 11/25/15	Tue 2/2/16	25FS-10 days	Motorola												
27	Installation & Alignment	10 days	Wed 2/3/16	Tue 2/16/16	26	Motorola												
28	Acceptance Testing	2 days	Wed 2/17/16	Thu 2/18/16	27	Motorola, Customer												
29	Acceptance	0 days	Thu 2/18/16	Thu 2/18/16	28	Milestone												
30	Bardstown Road Tower Site	47 days	Wed 9/30/15	Thu 12/3/15														
31	Site Survey/Readiness Reviews/NTP	1 day	Wed 9/30/15	Wed 9/30/15	7FS+10 days	Motorola, Customer												
32	NEPA Study	15 days	Thu 10/1/15	Wed 10/21/15	31	Motorola												
33	Structural Analysis, Tower Mapping, Foundation testing	20 days	Thu 10/1/15	Wed 10/28/15	31	Motorola												
34	Permitting	10 days	Thu 10/29/15	Wed 11/11/15	32,33	Motorola, Customer												
35	Tower Crew Mobilization and Set-up	1 day	Thu 11/12/15	Thu 11/12/15	34	Motorola												
36	Replace Tower Lighting	1 day	Mon 11/16/15	Mon 11/16/15	34FS+2 days	Motorola												

Project: Louisville P25 project schedul
Date: Sun 5/17/15

Task		Split		Manual Summary Rollup	
Critical Task		External Tasks		Manual Summary	
Milestone		Project Summary		Start-only	
Summary		Group By Summary		Finish-only	
Rolled Up Task		Inactive Milestone		External Tasks	
Rolled Up Critical Task		Inactive Summary		External Milestone	
Rolled Up Milestone		Manual Task		Progress	
Rolled Up Progress		Duration-only		Deadline	

Louisville P25 Upgrade

ID	Task Name	Duration	Start	Finish	Predecessors	Resource Names	01	20	20	20	20	20	20	20	20	20	20
							Qtr 3, 201	Qtr 3, 20	Qtr 4, 20	Qtr 1, 20	Qtr 2, 20	Qtr 3, 20	Qtr 3, 20	Qtr 3, 20	Qtr 3, 20	Qtr 3, 20	Qtr 3, 20
37	Install new antennas and lines	5 days	Tue 11/17/15	Mon 11/23/15	36,14	Motorola											
38	Sweep test new lines	0.5 days	Mon 11/23/15	Mon 11/23/15	37FF	Motorola											
39	Remove Existing Antenna, Dishes, lines, and ice bridge	8 days	Tue 11/24/15	Thu 12/3/15	38,48	Motorola											
40	Bardstown Road Acceptance	0 days	Thu 12/3/15	Thu 12/3/15	38,39	Motorola, Customer											
41	Fern Creek Tower Site	35.5 days	Wed 9/30/15	Wed 11/18/15													
42	Site Survey/Readiness Reviews/NTP	1 day	Wed 9/30/15	Wed 9/30/15	7FS+10 days	Motorola, Customer											
43	NEPA Study	15 days	Thu 10/1/15	Wed 10/21/15	42	Motorola											
44	Structural Analysis, Tower Mapping, Foundation testing	20 days	Thu 10/1/15	Wed 10/28/15	42	Motorola											
45	Permitting	10 days	Thu 10/29/15	Wed 11/11/15	43,44	Motorola, Customer											
46	Tower Crew Mobilization and Set-up	1 day	Thu 11/12/15	Thu 11/12/15	45	Motorola											
47	Install new antennas and lines	3 days	Fri 11/13/15	Tue 11/17/15	46,14	Motorola											
48	Sweep test new lines	0.5 days	Wed 11/18/15	Wed 11/18/15	47	Motorola											
49	Fern Creek Acceptance	0 days	Wed 11/18/15	Wed 11/18/15	48	Milestone											
50	Old Mitchell Road	6 days	Tue 10/27/15	Tue 11/3/15													
51	Deliver and install DC Power Plant	5 days	Tue 10/27/15	Mon 11/2/15	14	Motorola											
52	Test DC Power plant	1 day	Tue 11/3/15	Tue 11/3/15	51	Motorola											
53	DC Power Plant Acceptance	0 days	Tue 11/3/15	Tue 11/3/15	52	Milestone											
54	Site Development	0 days	Mon 12/14/15	Mon 12/14/15	20												

Project: Louisville P25 project schedul
Date: Sun 5/17/15

Task		Split		Manual Summary Rollup	
Critical Task		External Tasks		Manual Summary	
Milestone		Project Summary		Start-only	
Summary		Group By Summary		Finish-only	
Rolled Up Task		Inactive Milestone		External Tasks	
Rolled Up Critical Task		Inactive Summary		External Milestone	
Rolled Up Milestone		Manual Task		Progress	
Rolled Up Progress		Duration-only		Deadline	

Louisville P25 Upgrade

ID	Task Name	Duration	Start	Finish	Predecessors	Resource Names	01	20	20	20	20	20	20	20	20	20	20
							Qtr 3, 20	Qtr 3, 20	Qtr 4, 20	Qtr 1, 20	Qtr 2, 20	Qtr 3, 20	Qtr 3, 20	Qtr 3, 20	Qtr 3, 20	Qtr 3, 20	Qtr 3, 20
55	Site Development Complete (where applicable)	0 days	Mon 12/14/15	Mon 12/14/15	59	FF,7	Customer										
56	Training	25 days	Tue 3/22/16	Mon 4/25/16													
57	System Technical Training	25 days	Tue 3/22/16	Mon 4/25/16	78	FF	Motorola, Customer										
58	Equipment Installations	97 days	Fri 12/11/15	Mon 4/25/16													
59	Site Survey/Readiness Reviews	2 days	Fri 12/11/15	Mon 12/14/15	20		Motorola, Customer										
60	Core & RF Equipment Installations	15 days	Fri 12/11/15	Thu 12/31/15	20		Customer										
61	Fire Station Alerting	20 days	Fri 1/1/16	Thu 1/28/16	60,20		Motorola										
62	Consoles & Logging	20 days	Fri 1/29/16	Thu 2/25/16	20,61		Customer										
63	FNE Install Complete	0 days	Thu 2/25/16	Thu 2/25/16	60,62,59,61,53,49		Milestone										
64	Subscribers	42 days	Fri 2/26/16	Mon 4/25/16	63												
65	Inventory Subscribers	2 days	Fri 2/26/16	Mon 2/29/16	13		Motorola										
66	Develop and Test Subscriber Templates	10 days	Tue 3/1/16	Mon 3/14/16	65		Customer										
67	Program and Install Subscribers	30 days	Tue 3/15/16	Mon 4/25/16	66		Customer										
68	Subscribers ready!	0 days	Mon 4/25/16	Mon 4/25/16	67		Milestone										
69	System Optimization and Acceptance Testing	27 days	Fri 2/26/16	Mon 4/4/16													
70	System Optimization	5 days	Fri 2/26/16	Thu 3/3/16	63		Motorola										
71	Acceptance Testing	2 days	Fri 3/4/16	Mon 3/7/16	70		Motorola, Customer										
72	Acceptance Testing Complete	0 days	Mon 3/7/16	Mon 3/7/16	71		Milestone										

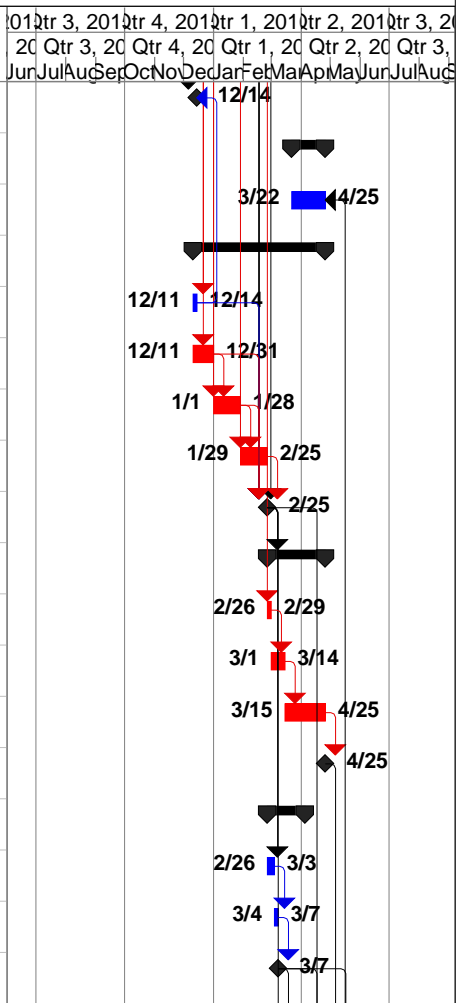

Project: Louisville P25 project schedul Date: Sun 5/17/15	Task		Split		Manual Summary Rollup	
	Critical Task		External Tasks		Manual Summary	
	Milestone		Project Summary		Start-only	
	Summary		Group By Summary		Finish-only	
	Rolled Up Task		Inactive Milestone		External Tasks	
	Rolled Up Critical Task		Inactive Summary		External Milestone	
	Rolled Up Milestone		Manual Task		Progress	
	Rolled Up Progress		Duration-only		Deadline	

Louisville P25 Upgrade

ID	Task Name	Duration	Start	Finish	Predecessors	Resource Names	Q1 2016	Q2 2016	Q3 2016	Q4 2016	Q1 2017	Q2 2017	Q3 2017	Q4 2017
							Jun	Jul	Aug	Sep	Oct	Nov	Dec	Jan
73	P25 Database Set-up	20 days	Tue 3/8/16	Mon 4/4/16	72									
74	Database "Freeze"	10 days	Tue 3/8/16	Mon 3/21/16	63	Motorola, Customer								
75	Import new Database	10 days	Tue 3/22/16	Mon 4/4/16	74	Customer								
76	Database set-up complete	0 days	Mon 4/4/16	Mon 4/4/16	75	Milestone								
77	Cutover	15 days	Mon 4/25/16	Mon 5/16/16										
78	End Users Ready!	0 days	Mon 4/25/16	Mon 4/25/16	76,63,68,72	Milestone								
79	Cutover End Users	5 days	Tue 4/26/16	Mon 5/2/16	78	Customer								
80	Install and cutover remaining consoles	10 days	Tue 5/3/16	Mon 5/16/16	79	Customer								
81	Cutover Complete	0 days	Mon 5/16/16	Mon 5/16/16	80	Milestone								
82	Finalize	22 days	Tue 5/17/16	Wed 6/15/16										
83	Final Inspection w/Customer	1 day	Tue 5/17/16	Tue 5/17/16	72,81	Motorola, Customer								
84	Punchlist Resolution	10 days	Wed 5/18/16	Tue 5/31/16	83	Motorola, Customer								
85	Finalize Documentation	10 days	Wed 6/1/16	Tue 6/14/16	84	Motorola								
86	Transition Service/PTC	1 day	Wed 6/15/16	Wed 6/15/16	85	Motorola, Customer								
87	Final Acceptance	0 days	Wed 6/15/16	Wed 6/15/16	86	Milestone								

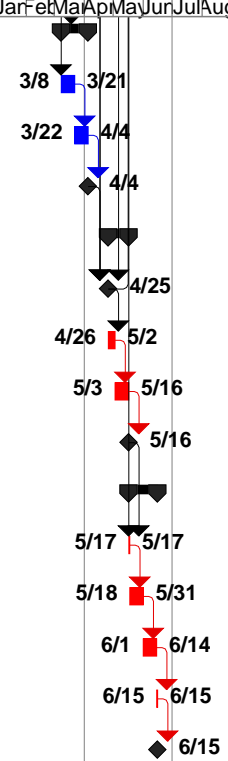

Project: Louisville P25 project schedul Date: Sun 5/17/15	Task		Split		Manual Summary Rollup	
	Critical Task		External Tasks		Manual Summary	
	Milestone		Project Summary		Start-only	
	Summary		Group By Summary		Finish-only	
	Rolled Up Task		Inactive Milestone		External Tasks	
	Rolled Up Critical Task		Inactive Summary		External Milestone	
	Rolled Up Milestone		Manual Task		Progress	
	Rolled Up Progress		Duration-only		Deadline	

EXHIBIT C-4

ACCEPTANCE TEST PLAN

METROSAFE COMMUNICATIONS MIGRATION PLAN

FEBRUARY 2015



The design, technical, pricing, and other information ("Information") furnished with this submission is proprietary information of Motorola Solutions, Inc. ("Motorola") and is submitted with the restriction that it is to be used for evaluation purposes only. To the fullest extent allowed by applicable law, the Information is not to be disclosed publicly or in any manner to anyone other than those required to evaluate the Information without the express written permission of Motorola.

MOTOROLA, MOTO, MOTOROLA SOLUTIONS, and the Stylized M Logo are trademarks or registered trademarks of Motorola Trademark Holdings, LLC and are used under license. SYMBOL is a trademark owned by Symbol Technologies, Inc., which is a wholly owned subsidiary of Motorola Solutions, Inc. All other trademarks are the property of their respective owners. © 2013 Motorola Solutions, Inc. All rights reserved.

TABLE OF CONTENTS

Exhibit C-4

- Acceptance Test Plan 1
 - 7.1 Overview 1
 - 7.2 Functional Acceptance Test Plan (FATP) 1
 - 7.2.1 Overview 1
 - 7.2.2 List of Acceptance Test Procedures 2
 - 7.3 Coverage Acceptance Test Plan (CATP)..... 4
 - 7.3.1 Overview 4

ACCEPTANCE TEST PLAN

7.1 OVERVIEW

Under the direction of the Motorola Project Manager, teams consisting of representatives from MetroSafe and Motorola will perform agreed-upon test procedures to confirm that the system has been designed and installed to meet all of the features and capabilities agreed upon in the contract. This section is a comprehensive Acceptance Test Plan written to meet the particular requirements of MetroSafe.

There are two basic types of acceptance test plans:

- **Functional Acceptance Test Plan (FATP)**—Demonstrates the features and functionality of the system. An FATP is completed at Motorola’s Customer Center for Solutions Integration (CCSi) prior to site installation.. CCSi testing allows the customer to see their equipment assembled under one roof, to witness the functional testing phase prior to shipment to the site, and to have the satisfaction of seeing the equipment operate before it leaves the facility for site installation. This is the “factory” FATP. Once the system is completely installed in the field another FATP is executed to demonstrate that the system is ready for use. This is referred to as the “system” ATP.
- **Coverage Acceptance Test Plan (CATP)**—A Coverage Acceptance Test is conducted to verify that the voice radio system implemented by Motorola meets or exceeds the required coverage reliability within Bowling Green/Warren County’s service area as indicated on Motorola’s coverage maps.

7.2 FUNCTIONAL ACCEPTANCE TEST PLAN (FATP)

7.2.1 Overview

The conduct of a Functional Acceptance Test Plan consists of executing pre-scripted procedures that demonstrate a portion of the radio system’s functionality. An example of a single procedure follows.



Trunking Features	2. TEST
<p>Continuous Assignment Updating</p>	
<p>1. DESCRIPTION</p>	
<p>When a talkgroup is assigned a voice channel, the site controller continues to transmit the channel assignment on the control channel for the duration of the talkgroup call. Radios coming into use on the system are automatically sent to voice channels with conversations in progress involving their selected talk groups.</p>	
<p>SETUP</p>	
<p>RADIO-1- TALKGROUP 1 RADIO-2- TALKGROUP 1 RADIO-3- TALKGROUP 1</p>	
<p>VERSION #1.080</p>	
	<p>Step 1. Turn OFF RADIO-1.</p> <p>Step 2. Initiate a Talk group Call using RADIO-2 and verify RADIO-3 hears the audio.</p> <p>Step 3. While the Talk group Call is in progress, turn ON RADIO-1.</p> <p>Step 4. Observe RADIO-1, which was just brought back into service, joins the Talkgroup Call already in progress.</p> <p>Step 5. End the talkgroup call.</p> <p>Step 6. Switch RADIO-1 to another talk group.</p> <p>Step 7. Initiate a Talk group Call from RADIO-2 to RADIO-3.</p> <p>Step 8. While the Talk group Call is in progress, set RADIO-1 back to TALKGROUP 1.</p> <p>Step 9. Observe that RADIO-1 joins the Talkgroup Call already in progress.</p>
	<p>Pass ___ Fail ___</p>

Figure 0-1: Example of a Functional Acceptance Test Procedure

7.2.2 List of Acceptance Test Procedures

Table 0-1 List of FATP Procedures

Talkgroup Call
Continuous Assignment Updating
Multigroup Call in Wait Mode
Call Alert
Private Call
Audio Interrupt / Interrupt Never Mode
Emergency Alarm and Call with Top of Queue
Site Trunking Indication
Talkgroup Call
Call Alert
Private Call
Continuous Assignment Updating
Busy Queuing and Callback
Emergency Call and Alarm
MCC 7100/7500 Trunked Resources
Instant Transmit
Talkgroup Selection and Call
Emergency Alarm and Call Display Description

Multigroup Call
Multi-Select Operation
Talkgroup Patch
Alert Tones - Talkgroup
Call Alert
Console Initiated Private Call to Subscriber
Console Priority
Activity Log
MCC 7100/7500 Conventional Resources
Console Priority
Alert Tones - Conventional Channel
Activity Log - Conventional
ID Stacking
Audio IP Logging
Logging Trunking Talkgroup Call
Logging Secure Trunking Talkgroup Call
Logging Subsystem - Emergency Events and Calls-Emergency Alarm
Logging Subsystem - Logging User Can Search Recorded Calls by Various Fields
Radio Control Manager (RCM) Features
Radio Check
Radio Snapshot
Dynamic Regrouping
Selective Radio Inhibit
Emergency Alarm Display
Fault Management
Unified Event Manager - Views
Station Power Amp Failure Reports to the Unified Event Manager (UEM)
Core Router Failure Reports to the Unified Event Manager
MOSCAD Fault Management System
Screen Navigation
InTouch Alarm Processing - Acknowledged Alarm
InTouch Alarm Processing - Unacknowledged Alarm
Physical Inputs/Outputs - Digital Outputs (SDM3000)
Report Generator
System Management Tests
ZoneWatch
Configuration Management - Access Permissions
Configuration Management - General Timeout Parameters
Configuration Management - Subscriber Capabilities
Configuration Management - Talkgroup Capabilities



Unified Event Manager - User Actions Create Audit Trails
System Reliability Features
Base Station Identification
Multiple Control Channels
Transmitter Power Failure Shutdown
Redundant Site Controller Switching - Automatic Switchover
Redundant Zone Controller Switching/Automatic Switchover

7.3 COVERAGE ACCEPTANCE TEST PLAN (CATP)

7.3.1 Overview

A Coverage Acceptance Test Plan (CATP) is not included as part of this proposal.

EXHIBIT D-1

WARRANTY / POST WARRANTY / LIFECYCLE

METROSAFE COMMUNICATIONS MIGRATION PLAN

FEBRUARY 2015



The design, technical, pricing, and other information ("Information") furnished with this submission is proprietary information of Motorola Solutions, Inc. ("Motorola") and is submitted with the restriction that it is to be used for evaluation purposes only. To the fullest extent allowed by applicable law, the Information is not to be disclosed publicly or in any manner to anyone other than those required to evaluate the Information without the express written permission of Motorola.

MOTOROLA, MOTO, MOTOROLA SOLUTIONS, and the Stylized M Logo are trademarks or registered trademarks of Motorola Trademark Holdings, LLC and are used under license. SYMBOL is a trademark owned by Symbol Technologies, Inc., which is a wholly owned subsidiary of Motorola Solutions, Inc. All other trademarks are the property of their respective owners. © 2013 Motorola Solutions, Inc. All rights reserved.

TABLE OF CONTENTS

Exhibit D-1

- Warranty / Post Warranty / Lifecycle 1
 - System Warranty Description 1
 - 8.1 Motorola Service Delivery Team..... 1
 - 8.2 Warranty Services 2
 - 8.2.1 Customer Support Plan (CSP) 2
 - 8.2.2 Dispatch Service..... 2
 - 8.2.3 OnSite Infrastructure Response..... 2
 - 8.2.4 Network Preventative Maintenance 2
 - 8.2.5 Infrastructure Repair with Advanced Replacement 3
 - 8.2.6 Technical Support Service 3
 - 8.2.7 Network Monitoring Service 3
 - 8.2.8 Security Update Service (SUS)..... 4
 - 8.2.9 Software Support..... 4
 - 8.2.10 NICE Logging Support..... 5
 - 8.3 Post Warranty maintenance Support 5
 - 8.4 Lifecycle Support Services 7
 - 8.5 Summary 8

WARRANTY / POST WARRANTY / LIFECYCLE

SYSTEM WARRANTY DESCRIPTION

Motorola's technical and service professionals use a structured approach to life cycle service delivery and provide comprehensive maintenance and support throughout the life of the system. The value of support is measured by system availability, which is optimized through the use of proactive processes, such as preventive maintenance, fault monitoring and active response management. System availability is a function of having in place a support plan delivered by highly skilled support professionals, backed by proven processes, tools, and continuous training.

8.1 MOTOROLA SERVICE DELIVERY TEAM

Customer Support Manager

Your Motorola Customer Support Manager provides coordination of support resources to enhance the quality of service delivery and to ensure your satisfaction. The Customer Support Manager (CSM) is responsible to oversee the execution of the Warranty and Service Agreement and ensure that Motorola meets its response and restoration cycle time commitments. The CSM will supervise and manage the Motorola Authorized Servicer's functions.

The Customer Support Manager establishes the maintenance and service support program throughout the warranty and post-warranty periods. Other tasks include:

- Coordinates Motorola service support resources to enhance the quality of service delivery and to ensure Louisville MetroSafe satisfaction over the life of their communication's system.
- Oversee the execution of MetroSafe's support contract (maintenance or warranty).
- Serves as the single point of contact for service issue resolution and escalation.

Motorola System Support Center

Located in Schaumburg, Illinois, the System Support Center (SSC) is a key component to the overall management and system maintenance. As detailed in this Customer Support Plan, the following services are provided by the System Support Center:

- Network Monitoring
- Dispatch Service
- Infrastructure Repair with Advanced Replacement
- Technical Support

Motorola Local Service Provider

Motorola's authorized service center, Owens Communications (OCI) are staffed with trained and qualified technicians. They will provide rapid on-site response to repair and restore troubled equipment. OCI will provide scheduled preventive maintenance tasks for site standards compliance and RF operability.



8.2 WARRANTY SERVICES

Motorola will provide a standard 1 year warranty maintenance service support plan per our standard warranty terms and conditions as outlined within the Communication Systems Agreement within this proposal. In addition to the Standard Commercial Warranty, the service products that comprise the Custom Warranty package are listed below along with a brief description.

8.2.1 Customer Support Plan (CSP)

At the start of warranty, Motorola will provide a Customer Support Plan (CSP) that has been created and agreed upon by MetroSafe and Motorola. The CSP will outline all of the service products described below, and the CSP will become the “directory” of services during warranty. The CSP will contain information regarding the specific requests, processes and responsibilities throughout the twelve (12) month support service period. The CSP will identify the specifics on escalation procedures in the event of special problems and any pertinent information required for each customer situation. Some of these details include items such as special access requirements to sites, issue initiation procedures, response time commitments, severity level definitions, parts department information, hardware/software information, and other miscellaneous contact information.

8.2.2 Dispatch Service

Motorola’s Dispatch Service ensures that trained and qualified technicians are dispatched to diagnose and restore your communications network. Following proven response and restoration processes, the local authorized service center in your area is contacted and a qualified technician is sent to your site. An automated escalation and case management process is followed to ensure that technician site arrival and system restoration comply with contracted response and restore times. Once the issue has been resolved, the System Support Center verifies resolution and with your approval, closes the case. Activity records are also available to provide a comprehensive history of site performance, issues, and resolution.

8.2.3 OnSite Infrastructure Response

Motorola OnSite Infrastructure Response provides local, trained and qualified technicians who arrive at your location to diagnose and restore your communications network. Following proven response and restore processes, Motorola Dispatch contacts the local authorized service center in your area and dispatches a qualified technician to your site. An automated escalation and case management process ensures that technician site arrival and system restoration comply with contracted response times. The field technician restores the system by performing first level troubleshooting on site. If the technician is unable to resolve the issue, the case is escalated to the System Support Center or product engineering teams as needed.

8.2.4 Network Preventative Maintenance

Network Preventative Maintenance provides an operational test and alignment on your infrastructure or fixed network equipment to ensure that it meets original manufacturer’s specifications. Trained technicians:

- Physically inspect equipment
- Remove dust and foreign substances
- Clean filters
- Measure, record, align and adjust equipment to meet original manufacturer’s specifications

This service is performed based on a schedule agreed upon between you and Motorola. Network Preventative Maintenance proactively detects issues that may result in system malfunctions and operational interruptions.

8.2.5 Infrastructure Repair with Advanced Replacement

Infrastructure Repair service provides for the repair of all Motorola-manufactured equipment, as well as equipment from third-party infrastructure vendors. All repair management is handled through a central location eliminating your need to send equipment to multiple locations.

Comprehensive test labs replicate your network in order to reproduce and analyze the issue. State-of-the-art, industry-standard repair tools enable our technicians to troubleshoot, analyze, test, and repair your equipment. Our ISO9001 and TL9000-certified processes and methodologies ensure that your equipment is quickly returned maintaining the highest quality standards.

Service agreements allow you to budget your maintenance costs on an annual basis. Equipment covered under service agreements also receives higher service priority, which results in quicker repair times.

Advanced Replacement provides a field replacement unit (FRU) in advance and in exchange for the customer's malfunctioning component from Infrastructure Depot Operation's (IDO's) inventory, Advanced Replacement FRUs are shipped overnight with high priority.

8.2.6 Technical Support Service

Motorola Technical Support service provides an additional layer of support through centralized, telephone consultation for issues that require a high level of communications network expertise and troubleshooting capabilities. Technical Support is delivered by the System Support Center (SSC). The SSC is staffed with trained, skilled technologists specializing in the diagnosis and swift resolution of network performance issues. These technologists have access to a solutions database as well as in house test labs and development engineers. Technical Support cases are continuously monitored against stringent inbound call management and case management standards to ensure rapid and consistent issue resolution. Technical Support service translates into measurable, customer-specific metrics for assured network performance and system availability.

8.2.7 Network Monitoring Service

Network Monitoring Service can help keep your network at optimum availability so it is ready to serve mission critical communications needs. By watching over the network continuously, Network Monitoring Service takes action whenever needed, and resolves network problems. We often intervene and correct the problem before you even know a problem exists. Network Monitoring Service provides improved productivity and enhanced network performance, which in turn helps to increase your technology Return-On-Investment.

Using a combination of network monitoring software, automated alerts, and remote diagnostics inquiries, our System Support technologists actively monitor your network to maximize network uptime and overall preparedness...for the expected *and* unexpected. Upon receiving an alert, our team immediately performs a series of diagnostics to assess the problem. Often the situation can be resolved remotely, but when additional attention is required, local field technicians are dispatched immediately to your site to achieve restoration.



Motorola's Network Monitoring service is a vital component of an intelligent communication support plan that keeps your business operating smoothly, your costs down, and assures maximum preparedness at all times.

Specifically, Network Monitoring Service provides:

- Improved network availability
- Remote and timely resolution to minimize downtime
- Cost efficiencies
- Optimize time at site due to assessment and knowledge transfer before dispatch
- Minimize unnecessary trips to site
- Mitigate need for 24x7 operations monitoring center
- Detailed Reports

8.2.8 Security Update Service (SUS)

Commercial security software updates are often designed without RF systems in mind and could cause inadvertent harm to your radio network, disrupting mission-critical communications and putting your first responders and citizens at risk. The Motorola Security Update Service assures that commercial anti-virus definitions, operating system software patches, and Intrusion Detection Sensor signature files are compatible with your ASTRO 25 network and do not interfere with network functionality. Our expert network security technologists analyze, perform testing, and validate the latest security software updates in a dedicated test lab and provide continuous monitoring of updates to provide you regular electronic updates upon completion of successful testing.

- Anti-virus definitions and intrusion detection sensor updates for Motorola supplied equipment from applicable original equipment manufacturer
- Minor releases may include commercial OS and application security updates, patches and service pack updates for Microsoft Windows and Server OS, Red Hat Linux, Sun Solaris and any Motorola software service packs that may be available
- Recommendations for IA remediation may include, but is not limited to the following: provide security software updates; provide operating system security updates or patches; implement configuration changes; upgrade to a later ASTRO 25 System Release (upgrade expense not included), or recommending a compensating control
- Regional partner invoicing provides ability to separate invoicing across multiple agencies

8.2.9 Software Support

Motorola guarantees its product software and will provide up to two System Enhancement Releases (SERs) per major system release which includes Motorola product or "box" patch / updates, and Failure Review Bulletins (FRB) product or "box" software repairs.

Motorola also provides regular periodic Field Service Bulletins to MetroSafe through our Motorola on Line (MOL) web based application. The Field Service Bulletins (FSB) describes both hardware and software solutions to issues identified in the technology. Prudent application of appropriate FSBs will contribute to the ongoing support of MetroSafe's ASTRO 25 communication system.

8.2.10 NICE Logging Support

Motorola-NICE Technical Support service provides an additional layer of support through centralized, telephone consultation for issues that require a high level of communications network expertise and troubleshooting capabilities. Technical Support is delivered by the system Support Center (SSC). The SSC is staffed with trained, skilled technologists specializing in the diagnosis and swift resolution of performance issues.

Motorola-NICE Infrastructure Repair service provides for the repair of all Motorola-manufactured equipment, as well as equipment from third-party infrastructure vendors. All repair management is handled through a central location eliminating your need to send equipment to multiple locations.

Motorola-NICE Dispatch Service and OnSite Infrastructure Response ensure that local, trained, and qualified technicians are dispatched to diagnose and restore your Motorola provided NICE equipment. Following proven response and restoration processes, the local authorized service center in your area is contacted and a qualified technician is sent to your site. An automated escalation and case management process is followed to ensure that technician site arrival and restoration comply with contracted response and restore times.

Once the issue has been resolved, the System Support Center verifies resolution and with your approval, closes the case. Activity records are also available to provide a comprehensive history of site performance, issues, and resolution.

Note: NICE Logging support assumes Customer agrees to granting NICE remote access to the local IP recorder for remote troubleshooting where majority of the logging issues can be resolved. See Appendix A of the implementation Statement of Work for NICE Remote Access Approval Form that will need to be completed by Customer and returned to Motorola.

Motorola-NICE support included with this offering is NICE Gold Support which includes 24x7 Remote and On-site support. See NICE Gold Maintenance Service SOW for further details.

8.3 POST WARRANTY MAINTENANCE SUPPORT

Motorola post warranty support includes Dispatch Service, Technical Support, Infrastructure Repair with Advanced Replacement, Security Updates, and Network Monitoring.

On-site Infrastructure Response and Network Preventative Maintenance are to be provided by MetroSafe.

Motorola Customer Support Manager will be responsible for reviewing Customer Support Plan with Customer prior to start of maintenance period.



This page intentionally left blank.



8.4 LIFECYCLE SUPPORT SERVICES

Modern LMR systems are specialized Information Technology (IT) networks that are a hybrid composition of commercial off-the-shelf IT components, specialized Radio Frequency (RF) components and software designed to comply with standards-based specifications. To ensure the highest level of operation, allow for system expansion, provide maximum lifespan and protect the initial investment, regular update and replacement of individual software and hardware components is required.

The Motorola System Upgrade Agreement is a comprehensive approach to technology refreshment of the ASTRO 25 system aligned with the Motorola lifecycle roadmap. The SUA II is a complete package of hardware, software and implementation services required to update the ASTRO 25 system on a biennial basis (once every two years) to a level consistent with the latest systems leaving the factory.

Updates to OEM components ensure availability of repair services support and may also provide increased capacity and processing speed. Regular updates enable system expansion (i.e. expansion of RF sites, dispatch positions, data sub-systems, network management positions, etc.). Professional implementation services guarantee live system upgrades are performed with minimal interruption to system operation with minimal reliance on owner resources. SUA II ensures the ASTRO 25 system functions at the highest level of operation, allows for expansion and feature enhancement and maximizes the lifespan of the investment. For owners that are committed to upgrading their system on a regular basis, SUA II offers a consistent budgeting solution that provides complete coverage.

Table 8-1: Included Features

	SUA II
Minor Release (patch release)	✓
Major Release (system release)	✓
Hardware Refresh	✓
Implementation Services	✓
Regional Partner Invoicing	available
Major upgrades in 2yr period	1

- Minor releases may include commercial OS and application security updates, patches and service pack updates for Microsoft Windows and Server OS, Red Hat Linux, Sun Solaris and any Motorola software service packs that may be available.
- Major releases include commercial OS and application software updates as well as Motorola system release software to improve the system functionality and operation from previous releases as well as significant new feature enhancements that are available for purchase.
- Hardware refresh includes version updates and/or replacements for Motorola FRU and third-party networking and computing hardware.
- Implementation services include all in-house and on-site resources to implement and test major release update.
- Regional partner invoicing provides ability to separate invoicing across multiple agencies.

8.5 SUMMARY

Whether it's a routine service call, or a disaster situation, Motorola understands its responsibility and takes pride in its commitment to deliver proven response service to the public safety community. Motorola has the capability to provide the technical, administrative, consultative, and maintenance repair services needed to support, enhance, and maintain the effectiveness of your communications network. Motorola's goal is to provide MetroSafe with the qualified resources, to maintain and improve system operation and availability, and to deliver world class service support



Statement of Work

ASTRO[®] 25 Network & Security Monitoring, Pre-Tested Software Subscription, OnSite Infrastructure Response and Dispatch Service

Overview: Network & Security Monitoring is a bundled service offering that provides Network Monitoring, Security Monitoring, Pre-Tested Software Subscription (PTSS), Dispatch and OnSite Infrastructure Response services to the Customer. This service is applicable only for the following system types: ASTRO 25 current shipping System Release and three prior System Releases.

Definitions

Terms that are capitalized but not defined in this Statement of Work shall have the definition given to such terms in the Service Terms and Conditions, the Communications System Agreement or other applicable agreement. The following terms have the following meanings:

- **Non-Motorola Software:** Software whose copyright is owned by a party other than Motorola or its affiliated company, including but not limited to the anti-virus definitions, operating system software patches and signature files that will be pre-tested pursuant to this Statement of Work.
- **Supported System Release:** Pre-Tested Software Subscription supports the current ASTRO 25 6.X and 7.X System Releases and 3 previous System Releases.

1.0 Description of Services

ASTRO 25 Network & Security Monitoring includes the monitoring of radio system infrastructure as well as monitoring and managing the Motorola security equipment present on the Customer's System. Monitoring security equipment requires Customer to purchase a Core Security Management Server with Customer's System. Motorola will monitor Elements of a System for Events, as set forth in the Monitored Elements Table below.

When the Motorola System Support Center (SSC) detects an Event, trained technologists will acknowledge the Event, run remote diagnostic routines, and initiate an appropriate Response. Appropriate responses could include, but are not limited to, continuing to monitor the Event for further development, attempting remote Restoral, or transferring the Event by opening a Case for dispatch of a Servicer. If dispatched, the Servicer will respond at the Customer location based on pre-defined Severity Levels set forth in the Severity Definitions Table and Response times set forth in the On-Site Response Time Table in order to Restore the System.

Pre-Tested Software Subscription provides the latest anti-virus definitions, intrusion detection sensor (IDS) signature updates (ONLY for IDS supplied to Customer by Motorola), Microsoft and Solaris operating system security patches that have been pre-tested on a Motorola test system to verify compatibility with the ASTRO 25 System.

Motorola will proactively manage the security Elements present on the System as needed to mitigate the risk of vulnerability such as a virus, worm or other intrusive attack on the System. This may include periodically deploying the latest release of pre-tested anti-virus definitions to the anti-virus management server and updating the intrusion detection sensor signature files on the network barrier (ONLY for IDS supplied to Customer by Motorola and if present on the System) as determined by Motorola. Motorola will also modify intrusion sensor settings and update firewall settings as determined by Motorola and will notify Customer of such modifications.

Motorola will provide Case Management as set forth herein. The SSC maintains contact with the on-site Servicer until System Restoral occurs and Case is closed. The SSC will Continuously track and manage Case activity from open to close through an automated Case tracking process. This Case management allows Motorola to provide activity and performance reports as well as ensures timely resolution of issues.

The terms and conditions of this Statement of Work (SOW) are an integral part of Motorola's Service Terms and Conditions or other applicable Agreement(s) to which it is attached and made a part thereof by this reference.

2.0 Motorola has the following responsibilities:

- 2.1. Provide dedicated Connectivity through a private network connection necessary for monitoring ASTRO 25 System. The Connectivity Matrix set forth below further describes the Connectivity options.
- 2.2. If determined necessary by Motorola, provide Motorola owned equipment for monitoring ASTRO 25 System elements. If Motorola installs or replaces Motorola owned equipment, the type of equipment and location installed is listed in the Motorola Owned & Supplied Equipment Table.
- 2.3. Verify Connectivity and Event monitoring prior to System Acceptance or Start Date.
- 2.4. Coordinate with Customer to maintain Motorola service authentication credentials.
- 2.5. Continuously receive service requests.
- 2.6. Perform Continuous monitoring of System Elements as set forth in the Monitored Elements Table.
- 2.7. Interpret System Events and determine appropriate Response. An appropriate Response could include the following actions: notify customer of activity, continue monitoring the Event for further development, review System log files or transfer the Event information via a Case for dispatch of a Servicer.
- 2.8. Respond in accordance to pre-defined Response times upon receipt from Customer of Customer managed passwords required for proper access to the Customer's System.
- 2.9. Remotely access the Customer's System to perform remote diagnostics as permitted by Customer pursuant to section 3.1.
- 2.10. Attempt remote Restoral, as appropriate. Some System functions may be disrupted as necessary to maintain System integrity until further validation of the Event occurs. This may include shutting down applications, applying security tools, resetting box, or instructing Servicer to reload applications and operating system software as necessary.
- 2.11. Create a Case as necessary when service requests are received. Gather information to perform the following:
 - 2.11.1. Characterize the issue
 - 2.11.2. Determine a plan of action
 - 2.11.3. Assign and track the Case to resolution.
- 2.12. Dispatch a Servicer, as required, by Motorola standard procedures and provide necessary Case information collected in section 2.11.
- 2.13. Ensure the required personnel have access to Customer information as needed.
- 2.14. Disable and enable System devices, as necessary, for Servicers.
- 2.15. Servicer will perform the following on-site:
 - 2.15.1. Run diagnostics on the Infrastructure or FRU.
 - 2.15.2. Replace defective Infrastructure or FRU, as applicable. Customer, Servicer or Motorola may provide Infrastructure or FRU.
 - 2.15.3. Provide materials, tools, documentation, physical planning manuals, diagnostic/test equipment and any Security requirements necessary to perform the Maintenance service.
 - 2.15.4. If a third party Vendor is needed to Restore the System, the Servicer may accompany that Vendor onto the Customer's premises.
- 2.16. Verify with Customer that Restoration is complete or System is functional, if required by Customer's repair Verification preference described in the Customer Support Plan required by section 3.6. If Verification by Customer cannot be completed within 20 minutes of Restoration, the Case will be closed and the Servicer will be released.
- 2.17. Escalate the Case to the appropriate party upon expiration of a Response time.
- 2.18. Close the Case upon receiving notification from Customer or Servicer, indicating the Case is resolved.
- 2.19. Notify Customer of Case Status, as described in the Customer Support Plan by section 3.6 at the following Case levels:
 - 2.19.1. Open and closed; or
 - 2.19.2. Open, assigned to the Servicer, arrival of the Servicer on site, deferred or delayed, closed.
- 2.20. Obtain anti-virus definitions for the Microsoft Windows platform, intrusion detection sensor (IDS) signatures for Motorola supplied IDS, Microsoft and Solaris operating system security patches/updates, as available, from Motorola selected commercial suppliers.

- 2.21. Evaluate anti-virus definitions classified as Category 4 (Severe, difficult to contain) and Category 5 (Very Severe, very difficult to contain) by Motorola selected commercial supplier to determine if a high-priority release is required. Motorola in its discretion will determine the urgency of the update based on the impact to the System.
- 2.22. Test anti-virus definitions, intrusion detection sensor signatures for Motorola supplied IDS, Microsoft and Solaris operating system security patches/updates by deploying them on a dedicated test System with the standard supported configurations, which include Motorola's then current approved cohabitated applications for current System Release and three previous System Releases.
- 2.23. Confirm that tested anti-virus definitions, intrusion detection sensor signatures for Motorola supplied IDS, and operating system security patches/updates do not degrade or compromise System functionality on dedicated test System within the standard supported configurations.
- 2.24. Address issues identified during testing to support functionality under the procedures specified in 2.22 above by working with Motorola selected commercial supplier or Motorola product development engineering team.
- 2.25. Deploy pre-tested updates weekly to anti-virus management server and intrusion detection sensor for Motorola supplied IDS (if present on the System) upon successful completion of the weekly test cycle to be completed one week after release by commercial supplier unless an issue is detected or as determined necessary by Motorola. High-priority anti-virus definition releases identified in 2.21 will be made available within 24 hours of commercial supplier release or at Motorola's discretion.
- 2.26. Notify Customer when anti-virus definition updates and intrusion detection sensor signatures have been deployed on Customer system.
- 2.27. Release and notify Customer when Microsoft and Solaris operating system security patches/updates are certified and available with instructions for obtaining patch for Customer deployment on the Customer system. Microsoft operating system security updates will be released monthly as available from Motorola selected commercial supplier upon successful completion of monthly test cycle. Solaris operating system security patches will be released quarterly upon successful completion of quarterly test cycle or at Motorola's discretion.
- 2.28. Maintain annual Customer licenses for anti-virus definitions and intrusion detection sensor signatures for IDS supplied to Customer by Motorola with Motorola selected commercial supplier.
- 2.29. Provide the following reports, as applicable:
 - 2.29.1. Case activity reports to Customer.
 - 2.29.2. Network Security Monitoring Service reports for Customer System(s).
 - 2.29.3. Network Activity/Availability Reports
- 2.30. Apply additional support charges above and beyond the contracted service agreements that may apply if it is determined that System faults were caused by the Customer making changes to critical System parameters.

3.0 Customer has the following responsibilities:

- 3.1. Allow Motorola Continuous remote access to obtain System availability, performance and configuration data.
- 3.2. Allow Motorola to access System if firewall has been installed; provide permanent/dedicated access for SNMP traps (outbound) and ZDS polling (inbound).
- 3.3. Provide continuous utility service to any Motorola equipment installed or utilized at Customer's premises to support delivery of the Service.
- 3.4. Maintain and manage any equipment outside of the System.
- 3.5. Deploy pre-tested operating system software patches on the System.
- 3.6. Provide Motorola with pre-defined Customer information and preferences prior to Start Date necessary to complete Customer Support Plan.
 - 3.6.1. Provide 7/24 security contact and escalation list
 - 3.6.2. Case notification preferences and procedures
 - 3.6.3. Repair Verification preference and procedure
 - 3.6.4. Database and escalation procedure forms.
 - 3.6.5. Submit changes in any information supplied in the Customer Support Plan to the Customer Support Manager.

- 3.7. Provide the following information when initiating a service request:
 - 3.7.1. Assigned System ID number
 - 3.7.2. Problem description and site location
 - 3.7.3. Other pertinent information for Motorola to open a Case.
- 3.8. Provide all Customer managed passwords required to access the Customer's System to Motorola upon request or when opening a Case to request service support or enable Response to a technical issue.
- 3.9. Notify the SSC when Customer performs any activity that impacts the System. (Activity that impacts the System may include, installing software or hardware upgrades, performing upgrades to the network, or taking down part of the System to perform maintenance.)
- 3.10. As necessary, upgrade System to Supported System Release as specified in paragraph 2.22.
- 3.11. Allow Servicers access to Equipment (including any Connectivity or monitoring equipment) if remote service is not possible.
- 3.12. Allow Servicers access to remove Motorola owned server upon cancellation of service as set forth in paragraph 2.2.
- 3.13. Supply Infrastructure or FRU, as applicable, in order for Motorola to Restore the System as set forth in paragraph 2.15.2.
- 3.14. Maintain and store in an easily accessible location System backups and any/all Software needed to Restore the System.
- 3.15. Verify with the SSC that Restoration is complete or System is functional, if required by the Repair Verification Preference provided by Customer in accordance with section 3.6.3.
- 3.16. Comply with the terms of the applicable license agreements between Customer and the Non-Motorola Software copyright owners.
- 3.17. Cooperate with Motorola and perform all acts that are reasonable or necessary to enable Motorola to provide the services described in this SOW.

4.0 WARRANTIES AND DISCLAIMER:

Motorola warrants that its services will be free of defects in materials and workmanship for a period of ninety (90) days following completion of the service. Your sole remedies are to require Motorola to re-perform the affected service or at Motorola's option to refund, on a pro-rata basis, the service fees paid for the affected service.

During the applicable Warranty Period, Motorola warrants that the tested anti-virus definitions, intrusion detection sensor signatures, and operating system security updates/patches do not degrade or compromise System functionality, and that after incorporation of the tested Software updates, the System Software, when used properly and in accordance with the Documentation, will be free from a reproducible defect that eliminates the functionality or successful operation of a feature critical to the primary functionality or successful operation of the Software. Product and Software documentation that specifies technical and performance features and capabilities, and the user, operation and training manuals for the Software (including all physical or electronic media upon which this information is provided) are collectively referred to as "Documentation." Whether a defect occurs will be determined solely with reference to the Documentation. Motorola does not warrant that Customer's use of the Software or Products will be uninterrupted or error-free or that the Software or the Products will meet Customer's particular requirements.

MOTOROLA DISCLAIMS ALL OTHER WARRANTIES WITH RESPECT TO PRE-TESTED ANTI-VIRUS DEFINITIONS, OPERATING SYSTEM SOFTWARE PATCHES, AND INTRUSION DETECTION SENSOR SIGNATURE FILES, EXPRESS OR IMPLIED, INCLUDING THE IMPLIED WARRANTIES OF MERCHANTABILITY, FITNESS FOR A PARTICULAR PURPOSE, AND NON-INFRINGEMENT. FURTHER, MOTOROLA DISCLAIMS ANY WARRANTY CONCERNING THE NON-MOTOROLA SOFTWARE AND DOES NOT GUARANTEE THAT CUSTOMER'S SYSTEM WILL BE ERROR-FREE OR IMMUNE TO VIRUSES OR WORMS AS A RESULT OF THESE SERVICES.

Severity Definitions Table

Severity Level	Problem Types
Severity 1	<ul style="list-style-type: none"> ▪ Response is provided Continuously ▪ Major System failure ▪ 33% of System down ▪ 33% of Site channels down ▪ Site Environment alarms (smoke, access, temp, AC power) as determined by SSC. ▪ This level is meant to represent a major issue that results in an unusable system, sub-system, Product, or critical features from the Customer's perspective. No Work-around or immediate solution is available.
Severity 2	<ul style="list-style-type: none"> ▪ Response during Standard Business Day ▪ Significant System Impairment not to exceed 33% of system down ▪ System problems presently being monitored ▪ This level is meant to represent a moderate issue that limits a Customer's normal use of the system, sub-system, product, or major non-critical features from a Customer's perspective
Severity 3	<ul style="list-style-type: none"> ▪ Response during Standard Business Day ▪ Intermittent system issues ▪ Information questions ▪ Upgrades/Preventative maintenance ▪ This level is meant to represent a minor issue that does not preclude use of the system, sub-system, product, or critical features from a Customer's perspective. It may also represent a cosmetic issue, including documentation errors, general usage questions, recommendations for product enhancements or modifications, and scheduled events such as preventative maintenance or product/system upgrades.

On-Site Response Time Table (Customer's Response Time Classification is designated in the Service Agreement).

Severity Level	Standard Response Time	Premier Response Time	Limited Response Time	Restoral	Off Deferral
Severity 1	Within 4 hours from receipt of Notification Continuously	Within 2 hours from receipt of Notification Continuously	Within 4 hours from receipt of Notification Standard Business Day	8 hours	Time provided by Servicer *
Severity 2	Within 4 hours from receipt of Notification Standard Business Day	Within 4 hours from receipt of Notification Standard Business Day	Within 4 hours from receipt of Notification Standard Business Day	8 hours	Time provided by Servicer *
Severity 3	Within 24 hours from receipt of Notification Standard Business Day	Within 24 hours from receipt of Notification Standard Business Day	Within 24 hours from receipt of Notification Standard Business Day	48 hours	Time provided by Servicer *

- Please note these are Standard Commitment times. The commitment times should be based on the Customers Support Plan.
 - Provide update **before** the specific contractual commitments come due.
- * Note: Provide update to System Support Center **before** Deferral time comes due.

Connectivity Matrix

Private Network Connection IP VPN (All Customers)	Public Internet Connection IP VPN (Option Available only to Customers outside of the US)
Standard solution for real-time Connectivity	Non-standard solution for real-time Connectivity
Dedicated bandwidth configuration provided to monitor Customers	No dedicated bandwidth provided to monitor Customers
Protected from unauthorized intrusion	Low risk of unauthorized intrusion
Encryption Available	Encryption Available
Connectivity available through Motorola	Customer provides Connectivity to the internet via an internet service provider selected by Customer

Motorola Owned & Supplied Equipment Table

Equipment Type	Location Installed
Firewall/Router	Master Site
System Support Server	Master Site for each Zone

Monitored Elements Table
(Listed by Technology)

System Type	Equipment
ASTRO 25 (release 7.x)	<p>Packet Routing Network; Zone Controllers; Database Server; FullVision Server; Zone Statistical Server; Air Traffic Router; System Statistics Server; User Configuration Server; Packet Data Gateway Server; PBX; Interconnect Server; Motorola Gold Elite Gateway (MGEG); AEB; CEB; Conventional Channel Gateway (CCGW); Simulcast RF Site (Site Controllers, Comparators, Stations); Intelli Repeater RF Site (Stations); Intelli Site Repeater RF Site (Site Controllers, Stations);</p> <p>Core, Exit, Gateway, Peripheral, Border, and Site routers, HP Switches master, prime, console and repeater sites switches, GGSN; CWR</p> <p>MOSCAD Overlay (TenSr, Station, Channel Banks, TRAK GPS, Site Power, Microwave)</p> <p>DOES NOT INCLUDE MONITORING OF ANY MOSCAD ALARM POINTS THAT DO NOT DIRECTLY IMPACT THE PERFORMANCE OF THE RADIO NETWORK. DOES NOT INCLUDE MONITORING OF ANYTHING OUTSIDE OF THE RADIO NETWORK UNLESS SPECIFICALLY STATED</p>
ASTRO 25 (release 6.3 – 6.9)	<p>Nortel; Packet Routing Network; Zone Controllers; Database Server; FullVision Server; Zone Statistical Server; Air Traffic Router; System Statistics Server; User Configuration Server; Packet Data Gateway Server; PBX; Interconnect Server; Motorola Gold Elite Gateway (MGEG); AEB; CEB; ARCADACS Cross Connect Switch; Simulcast RF Site (Site Controllers, Comparators, Stations); Intelli Repeater RF Site (Stations);Intelli Site Repeater RF Site (Site Controllers, Stations);</p> <p>MOSCAD Overlay (TenSr, Station, Channel Banks, TRAK GPS, Site Power, Microwave)</p> <p>DOES NOT INCLUDE MONITORING OF ANY MOSCAD ALARM POINTS THAT DO NOT DIRECTLY IMPACT THE PERFORMANCE OF THE RADIO NETWORK. DOES NOT INCLUDE MONITORING OF ANYTHING OUTSIDE OF THE RADIO NETWORK UNLESS SPECIFICALLY STATED.</p>
Security Elements (Monitoring and managing Security Elements is dependent on Customer purchasing Core Security Management Server as Equipment with the Customer System)	Core Security Management Server; Firewall; Intrusion Detection Sensors; Anti-virus Management application; Authentication Management application; Centralized Logging Server

Statement of Work

Infrastructure Repair with Advanced Replacement

1.0 Description of Services

Infrastructure Repair with Advanced Replacement is a repair service for Motorola and select third party Infrastructure as set forth in the applicable attached Exhibit(s), all of which are hereby incorporated into this Statement of Work (SOW) by this reference. Infrastructure may be repaired down to the Component level, as applicable, at the Motorola Infrastructure Depot Operations (IDO). At Motorola's discretion, select third party Infrastructure may be sent to the original equipment manufacturer or third party vendor for repair. If Infrastructure is no longer supported by the original equipment manufacturer or third party vendor, Motorola may replace Infrastructure with similar Infrastructure, when possible.

When available, Motorola will provide Customer with an Advanced Replacement unit(s) or FRU(s) in exchange for Customer's malfunctioning FRU(s). Non-standard configurations, Customer-modified Infrastructure and certain third party Infrastructure are excluded from Advanced Replacement service. Malfunctioning FRU (s) will be evaluated and repaired by IDO and returned to IDO FRU inventory upon completion of repair.

The terms and conditions of this SOW are an integral part of Motorola's Service Terms and Conditions or other applicable agreement to which it is attached and made a part thereof by this reference.

2.0 Motorola has the following responsibilities:

- 2.1. Use commercially reasonable efforts to maintain an inventory of FRU.
- 2.2. Provide new or reconditioned units as FRU to Customer or Servicer, upon request and subject to availability. The FRU will be of similar kit and version, and will contain like boards and chips, as the Customer's malfunctioning Infrastructure.
- 2.3. Program FRU to original operating parameters based on templates provided by Customer as required in Section 3.5. If Customer template is not provided or is not reasonably usable, a standard default template will be used.
- 2.4. Properly package and ship Advanced Replacement FRU from IDO or select third party FRU inventory to Customer specified address.
 - 2.4.1. During normal operating hours of Monday through Friday 7:00am to 7:00pm CST, excluding holidays, FRU will be sent next day air via Federal Express Priority Overnight or UPS Red, unless otherwise requested. Select third party FRU may ship second day air via Federal Express Priority Overnight or UPS red as noted in the attached exhibit(s). Motorola will pay for such shipping, unless Customer requests shipments outside of the above mentioned standard business hours and/or carrier programs, such as NFO (next flight out). In such cases, Customer will be subject to shipping and handling charges.
 - 2.4.2. When sending the Advanced Replacement FRU to Customer, provide a return air bill in order for Customer to return the Customer's malfunctioning FRU. The Customer's malfunctioning FRU will become property of IDO or select third party and the Customer will own the Advanced Replacement FRU.
 - 2.4.3. When sending a Loaner FRU to Customer, IDO will not provide a return air bill for the malfunctioning Infrastructure. The Customer is responsible to arrange and pay for shipping the malfunctioning Infrastructure to IDO. IDO will repair and return the Customer's Infrastructure and will provide a return air bill for the customer to return IDO's Loaner FRU.
- 2.5. Provide repair return authorization number upon Customer request for Infrastructure that is not classified as an Advanced Replacement or Loaner FRU.
- 2.6. Receive malfunctioning Infrastructure from Customer and document its arrival, repair and return.
- 2.7. Perform the following service on Motorola Infrastructure:

- 2.7.1. Perform an operational check on the Infrastructure to determine the nature of the problem.
 - 2.7.2. Replace malfunctioning FRU or Components.
 - 2.7.3. Verify that Motorola Infrastructure is returned to Motorola manufactured specifications, as applicable
 - 2.7.4. Perform a Box Unit Test on all serviced Infrastructure.
 - 2.7.5. Perform a System Test on select Infrastructure.
 - 2.8. Provide the following service on select third party Infrastructure:
 - 2.8.1. Perform pre-diagnostic and repair services to confirm Infrastructure malfunction and eliminate sending Infrastructure with no trouble found (NTF) to third party vendor for repair, when applicable.
 - 2.8.2. Ship malfunctioning Infrastructure to the original equipment manufacturer or third party vendor for repair service, when applicable.
 - 2.8.3. Track Infrastructure sent to the original equipment manufacturer or third party vendor for service.
 - 2.8.4. Perform a post-test after repair by Motorola, original equipment manufacturer, or third party vendor to confirm malfunctioning Infrastructure has been repaired and functions properly in a Motorola System configuration, when applicable.
 - 2.9. Re-program repaired Infrastructure to original operating parameters based on templates provided by Customer as required by Section 3.5. If Customer template is not provided or is not reasonably usable, a standard default template will be used. If IDO determines that the malfunctioning Infrastructure is due to a Software defect, IDO reserves the right to reload Infrastructure with a similar Software version. Enhancement Release(s), if needed, are subject to additional charges to be paid by Customer unless the Customer has a Motorola Software Subscription agreement.
 - 2.10. Properly package repaired Infrastructure unless Customer's malfunctioning FRU was exchanged with an IDO FRU. Motorola will return Customer's FRU(s) to IDO's FRU inventory, upon completion of repair.
 - 2.11. Ship repaired Infrastructure to the Customer specified address during normal operating hours set forth in 2.4.1. FRU will be sent two-day air unless otherwise requested. Motorola will pay for such shipping, unless Customer requests shipments outside of the above mentioned standard business hours and/or carrier programs, such as NFO (next flight out). In such cases, Customer will be subject to shipping and handling charges.
- 3.0 Customer has the following responsibilities:
- 3.1. Contact or instruct Servicer to contact the Motorola System Support Center (SSC) and request an Advanced Replacement, or Loaner FRU and a return authorization number (necessary for all non-Advanced Replacement repairs) prior to shipping malfunctioning Infrastructure or third party Infrastructure named in the applicable attached Exhibit.
 - 3.1.1. Provide model description, model number, serial number, type of System and Firmware version, symptom of problem and address of site location for FRU or Infrastructure.
 - 3.1.2. Indicate if Infrastructure or third party Infrastructure being sent in for service was subjected to physical damage or lightning damage.
 - 3.1.3. Follow Motorola instructions regarding inclusion or removal of Firmware and Software applications from Infrastructure being sent in for service.
 - 3.1.4. Provide Customer purchase order number to secure payment for any costs described herein.
 - 3.2 Pay for shipping of Advanced Replacement or Loaner FRU from IDO if Customer requested shipping outside of standard business hours or carrier programs set forth in section 2.4.1.
 - 3.3 Within five (5) days of receipt of the Advanced Replacement FRU from IDO's FRU inventory, properly package Customer's malfunctioning Infrastructure and ship the malfunctioning Infrastructure to IDO for evaluation and repair as set forth in 2.7. Customer must send the return air bill, referenced in 2.4.2 above back to IDO in order to ensure proper tracking of the returned Infrastructure. Customer will be subject to a replacement fee for malfunctioning Infrastructure not properly returned. For Infrastructure and/or third party Infrastructure repairs that are not exchanged in advance, properly package Infrastructure and ship the malfunctioning FRU, at Customer's expense and risk of loss to Motorola. Customer is responsible for properly packaging the Customer malfunctioning Infrastructure FRU to ensure that the shipped



Infrastructure arrives un-damaged and in repairable condition. Clearly print the return authorization number on the outside of the packaging.

- 3.4 If received, Customer must properly package and ship Loaner FRU back to IDO within five (5) days of receipt of Customer's repaired FRU.
 - 3.5 Maintain templates of Software/applications and Firmware for reloading of Infrastructure as set forth in paragraph 2.3 and 2.9.
 - 3.6 For Digital In-Car Video Infrastructure, remove video from equipment prior to sending Infrastructure in for repair. Video retrieval is a separate service and is not included as part of this SOW. Additional services and fee applies.
 - 3.7 Cooperate with Motorola and perform all acts that are reasonable or necessary to enable Motorola to provide the Infrastructure Repair with Advanced Replacement services to Customer.
- 4.0 In addition to any exclusions named in Section 5 of the Service Terms and Conditions or in any other underlying Agreement to which this SOW is attached, the following items are excluded from Infrastructure Repair with Advanced Replacement:
1. All Infrastructure over seven (7) years from product cancellation date.
 2. All Broadband/WiNS Infrastructure three (3) years from product cancellation date.
 3. Physically damaged Infrastructure.
 4. Third party Equipment not shipped by Motorola.
 5. Consumable items including, but not limited to, batteries, connectors, cables, tone/ink cartridges.
 6. Video retrieval from Digital In-Car Video equipment.
 7. Test equipment.
 8. Racks, furniture and cabinets.
 9. Firmware and/or Software upgrades.

ASTRO® 25 Infrastructure Exhibit	Inclusions, Exclusions, Exceptions and Notes
Antenna Systems	Excludes all Equipment such as bi-directional amplifiers, multicouplers, combiners, tower top pre-amplifiers, antennas, cables, towers, tower lighting, and transmission lines
Backhaul	Includes PTP (Point-to-Point Wireless) PTP 49600 and PTP 800 licensed series Excludes all other PTP technologies
Base Station(s) and Repeater(s)	Includes Quantar, MTR3000, STR3000, GTR8000, GTR8000 HPD, IntelliRepeater, Network Management (Please refer to the SOW for details) is not available on all stations. Quantar high power booster power amplifier, power supply and control board Excludes Fan Modules, Dual Circulator Tray, Site RMC Tray
Central Electronics Bank(s)	Includes Logging Recorder Interface and Network Hub, NICE logging recorders Excludes all other technologies
Channel Bank(s)	Includes Premisys , Telco, IMACS models 600, 800 . Excludes Siemens
Comparator(s)	Includes Spectratrac, Digitac, and ASTRO-tac 9600, ASTRO-tac 3000, GMC8000, Comparators.
Computer(s)/Workstations/Modems	Includes computers (Pentium I, II, III, IV) directly interface with or control the communications System, including Systemwatch II, PT800 tablet HP x1100, HPx2100, HP xw4000-4600, HPz400, HP VL600, HP VL800, HPz400, ML850 laptop, MW810, ML900 laptop, ML910 laptop, Compaq XW4000. Includes keyboards, mice, trackballs. Excludes all other laptop and desktop computer technologies and all 286, 386, 486 computers; defective or phosphor-burned cathode ray tubes CRT(s) and burned-in flat panel display image retention,
Console(s)	Includes Centracom Gold Elite, MCC7500, MCC5500, MIP5000, VPM, as part of complete communication System – including headset jacks, dual footswitches, and gooseneck microphones. Excludes cables
Controller - trunking	Includes SmartNet II prime and remote controllers, MTC3600, GCP8000, Site Controller PSC9600, CSC7000, MTC9600, MZC3600, MZC5000 (Includes Netra240 & T5220). Excludes SSMT and SCMS controllers. CD ROM Drive, Fan Tray
Dictaphones and Recording Equipment	Excludes all types and models.
Digital Interface Unit(s)	Included
Digital Signaling Modem(s)	Included upon modem model availability
Digital Voice Modem(s)	Included upon modem model availability
Embassy Switch	Includes AEB, AIMI, ZAMBI, AMB
Keyload Variable Loader	Included
Firewalls	Includes Nortel Alteon ASF5105, 5106, Juniper SS520, ISSG140, SSG5, ISG1000C, ISG2000
Intrusion Detector	Includes Proventia 201 Linux IDSS, Proventia CX4002C
ISSI Gateway	Includes T5220 Sun server Solaris 10 OS
Links	Includes PTP 49600 and 800 licensed series
Logging Recorder	Includes NICE Excludes all other technologies
Management Terminals	Includes computers (Pentium I, II, III, IV) that directly interface with or control the communications System, including Systemwatch II. Excludes laptop computers and all 286, 386, 486 computers.
MBEX(s) or NOVA Interconnect	Included
Microwave Equipment.	Excluded from service agreement but may be repaired on an above contract, time and material basis. All Equipment must be shipped to IDO. Excludes any on-site services.
Monitor(s)	Includes all Motorola certified monitors connected to computers that directly interface with or control the communications System. Excludes defective or phosphor-burned cathode ray tubes CRT(s) and burned-in flat panel displays image retention, as well as monitors that were not shipped by Motorola and/or cannot be confirmed by a Motorola factory order number.
Motobridge	Included
Moscad	Includes NFM (Network Fault Management), as part of communication System only, RTU, SDM Site Manager RTU. Standalone MOSCAD and System Control and Data Acquisition (SCADA) must be quoted separately. Includes FSA4000. Excludes all other fire alarming systems.

ASTRO 25 Infrastructure Repair cont.	Inclusions, Exclusions, Exceptions and Notes
Network Fault Management	Includes Full Vision, Unified Event Manager Excludes NMC
Gateway	Includes PDG:CPX8216, IVD & HPD PDG on HP DL360, MOTOBRIDGE
Printer(s)	Includes printers that directly interface with the communications system.
RAS(s)	Excludes RAS 1100, 1101 and 1102
Receiver(s)	Includes Quantar, MTR2000 and ASTRO-TAC, GPW8000, GTR8000, GTR8000 HPD Receivers. Excludes Fan Modules, Dual Circulator Tray, Site RMC Tray
Routers	Includes GGM8000, ST5500, ST5598, S2500-S6000
Servers	Includes Netra 240, Netra T5220, cPCI, HP DL360, HP ML370, HP ML110, HP ML530, HP TC2110, 2120 HP InfoVista Server. IR8000 series, LX4000 series, Intel Server TSRL-T2, TIGPR2U, Proventia 201 Linux IDSS, Proventia GX4002C, Trak9100. Network Management Server includes cPCI Chassis, Power Supply, Fan Tray, Controller Hard Drive, CD ROM Drive, Tape Drive, CPU, Client PC's, Core Security Management Server, Firewall Servers, Intrusion Detection Sensor Server. Excludes Dell Servers, Monitors, Memory Module 0182915Y02, Rear Fan RLN5352, Central Process Card 0182915Y01
Simulcast Distribution Amplifier(s)	Included
Site Frequency Standard(s)	Includes Rubidium, GPS and Netlocks systems sold with the Motorola System.
Secure	Includes KMF crypto card, end to end Cryptor for IVD PDEG Cryptr
SMARTX	Includes VPM
Switch	Includes Nortel Passport PBX, Cisco Catalyst 6509, HP 5308 LAN switch, HP ProCurve Switch 2524, 2650, 2626, HP3500, HP2610, 3Com PS40, SS1100
Telco PBX	Includes Avaya Dfinity PBX, S8300, S8500, Intel Server (ACSS), TSRLT2, TIGPR2U
Terminal Servers	Includes IR8000, LX4000S, LX4000T, Paradyne
Universal Simulcast Controller Interface(s)	Included
UPS Systems	Excluded from service agreements but may be repaired on an above contract, time and material basis. All UPS Systems must be shipped to IDO for repair. Excludes batteries and any on-site services.
Workstation	Included



SmartZone System Infrastructure Exhibit	Inclusions, Exclusions, Exceptions and Notes
Antenna Systems	Excludes all Equipment such as bi-directional amplifiers, multicouplers, combiners, tower top pre-amplifiers, antennas, cables, towers, tower lighting, and transmission lines.
Base Station(s) and Repeater(s)	Includes: Quantar, Quantro, Digital, MTR2000 ONLY.
Central Electronics Bank(s)	Includes Logging Recorder, Interface and Network Hub, NICE logging recorders Excludes all other technologies
Channel Bank(s)	Includes Premisys and Telco Excludes Siemens
Comparator(s)	Includes Spectratrac, Digitac, and ASTRO-tac Comparators
Computer(s)	Includes computers (Pentium I, II, III, IV) that directly interface with or control the communications System, including Systemwatch II, keyboards, mice and trackballs. Excludes laptop computers and all 286, 386, 486 computers, defective or phosphor-burned cathode ray tubes CRT(s) and burned-in flat panel display image retention.
Console(s)	Includes Centracom Gold Elite, MCC7500, MCC5500, MIP5000 as part of complete communication System – including headset jacks, dual footswitches, and gooseneck microphones. Excludes cables
Controller(s) -Trunking	Includes SmartNet II prime and remote controllers. Excludes SSMT and SCMS controllers.
Dictaphones, Logging Recorders and Recording Equipment	Includes NICE Excludes all other technologies
Digital Interface Unit(s)	Included
Digital Signaling Modem(s)	Included upon modem model availability
Digital Voice Modem(s)	Included upon modem model availability
Embassy Switch	Includes AEB, AIMI, ZAMBI, AMB
Management Terminals	Includes computers (Pentium I, II, III, IV) that directly interface with or control the communications System, including Systemwatch II. Excludes laptop computers and all 286, 386, 486 computers.
MBEX(s) or NOVA Interconnect	Included
Microwave Equipment.	Excluded from service agreement but may be repaired on an above contract, time and material basis. All Equipment must be shipped to IDO. Excludes any on-site services.
Monitor(s)	Includes all Motorola certified monitors connected to computers that directly interface with or control the communications System. Excludes defective or phosphor-burned cathode ray tubes CRT(s) and burned-in flat panel displays image retention as well as monitors that were not shipped by Motorola and/or cannot be confirmed by a Motorola factory order number.
Moscad	Includes NFM (Network Fault Management), as part of communication System only. Standalone MOSCAD and System Control and Data Acquisition (SCADA) must be quoted separately. Includes FSA4000. Excludes all other fire alarming systems.
Motobridge	Included
Network Fault Management	Includes Full Vision Excludes NMC
Printer(s)	Includes printers that directly interface with the communications System.
RAS(s)	Excludes RAS 1100, 1101 and 1102
Receiver(s)	Includes Quantar and MTR2000, ASTRO-TAC Receivers
Simulcast Distribution Amplifier(s)	Included
Site Frequency Standard(s)	Includes Rubidium, GPS and Netclocks systems sold with the Motorola System. Excludes MFS -Rubidium Standard Network Time and Frequency devices
Universal Simulcast Controller Interface(s)	Included
UPS Systems.	Excluded from service agreements but may be repaired on an above contract, time and material basis. All UPS Systems must be shipped to IDO for repair. Excludes batteries and any on-site services.

SmartZone System Infrastructure cont.	Inclusions, Exclusions, Exceptions and Notes
Zone Manager	Excludes HP715/33, HP 715/50 servers. Excludes x-terminals NDS14C and NDS17C
Zone Controller(s)	Includes console terminals. Excludes all Sun/IMP hard drives <u>except</u> TLN3495A 0820 1 GB drive as well as the following SUN/IMP CPUSET's: TLN3278B 0406, TLN3343A 0424 and TLN3278A 0181/0389.

SmartNet System Infrastructure Exhibit	Inclusions, Exclusions, Exceptions and Notes
Antenna Systems	Excludes all Equipment such as bi-directional amplifiers, multicouplers, combiners, tower top pre-amplifiers, antennas, cables, towers, tower lighting, and transmission lines
Base Station(s) and Repeater(s)	Includes Quantar, Quantro, Digital MSF5000, MTR2000, and Desktrac L35SUM7000-T Repeaters ONLY. Network Management (please refer to the SOW for details) is not available on all stations.
Central Electronics Bank(s)	Includes Logging Recorder Interface and Network Hub, NICE logging recorders Excludes all other technologies
Channel Bank(s)	Includes Premisys and Telco. Excludes Siemens
Comparator(s)	Includes Spectratrac, Digitac, and ASTRO-tac Comparators.
Computer(s)	Includes computers (Pentium I, II, III, IV) directly interface with or control the communications System, including Systemwatch II, keyboards, mice and trackballs, defective or phosphor-burned cathode ray tubes CRT(s) and burned-in flat panel display image retention.
Console(s)	Includes Centracom Gold Elite, MCC7500, MCC5500, MIP5000 as part of complete communication System – including headset jacks, dual footswitches, and gooseneck microphones. Excludes cables
Controller - trunking	Includes SmartNet II prime and remote controllers. Excludes SSMT and SCMS controllers.
Dictaphones, Logging Recorders and Recording Equipment	Includes NICE Excludes all other technologies
Digital Interface Unit(s)	Included
Digital Signaling Modem(s)	Included upon modem model availability
Digital Voice Modem(s)	Included upon modem model availability
Embassy Switch	Includes AEB, AIMI, ZAMBI, AMB
Management Terminals	Includes computers (Pentium I, II, III, IV) directly interface with or control the communications System, including Systemwatch II. Excludes laptop computers and all 286, 386, 486 computers.
MBEX(s) or NOVA Interconnect	Included
Microwave Equipment.	Excluded from service agreement but may be repaired on an above contract, time and material basis. All Equipment must be shipped to IDO. Excludes any on-site services.
Monitor(s)	Includes all Motorola certified monitors connected to computers that directly interface with or control the communications System. Excludes defective or phosphor-burned cathode ray tubes CRT(s) and burned-in flat panel displays image retention as well as monitors not shipped by Motorola and/or cannot be confirmed by a Motorola factory order number.
Moscad	INFM (Network Fault Management), as part of communication System only. Standalone MOSCAD and System Control and Data Acquisition (SCADA) must be quoted separately. Includes FSA4000. Excludes all other fire alarming systems.
Motobridge	Included
Network Fault Management	Includes Full Vision. Excludes NMC
Printer(s)	Includes printers that directly interface with the communications System.
RAS(s)	Excludes RAS 1100, 1101 and 1102
Receiver(s)	Includes Quantar, MTR2000 and ASTRO-TAC Receivers.

SmartNet System Infrastructure cont.	Inclusions, Exclusions, Exceptions and Notes
Simulcast Distribution Amplifier(s)	Included
Site Frequency Standard(s)	Includes Rubidium, GPS and Netclocks systems sold with the Motorola System. Excludes MFS -Rubidium Standard Network Time and Frequency devices
Universal Simulcast Controller Interface(s)	Included
UPS Systems.	Excluded from service agreements but may be repaired on an above contract, time and material basis. All UPS Systems must be shipped to IDO for repair. Excludes batteries and any on-site services.

Broadband Infrastructure Exhibit	Inclusions, Exclusions, Exceptions and Notes
Access Points	Includes PMP (Canopy), Motomesh Duo, Motomesh Quattro, Meshcam, Motomesh Solo, Motomesh AP7181 intelligent access points. Excludes all other technologies
Backhaul	Includes PMP (Canopy) and PTP (Point-to-Point Wireless) PTP 49600 and 800 licensed series Excludes all other technologies
Cables, connectors and testers	Excluded
Cameras	Includes Meshcam Excludes all other technologies, fixed black & white, color, pan tilt zoom analog, pan tilt zoom IP, fixed hybrid (IP and Analog) cameras
Cluster Management Modules (CMM)	Includes PMP (Canopy). Excludes all other technologies
Digital Video Recorder	Includes Mobile Video Enforcer Excludes all other technologies
Docking Station	Includes Mobile Video Enforcer Excludes all other technologies
GPS Synch Box	Excluded
Links	Includes PTP 49600 and 800 licensed series
Mobile Internet Switching Controller(MISC)	Excluded
Modems	Includes Mobile Video Enforcer Excludes all other technologies
Monitors	Includes Mesh,MotoMesh Excludes all other technologies
Mounting Bracket	Excluded
Multiplexers	Excluded
Network Interface Card	Excludes RAD data multiplexers
Network Switches	Includes Mesh, MotoMesh, Meshcam Excludes all other technologies
Networking Enablers	Included
Personal Tracking Device	Excludes Asymmetric DSL Broadband Gateway, Asymmetric Customer Premise Equipment, Symmetric DSL Broadband Gateway, Symmetric DSL-CPE's and accessories
Power Supply	Includes MeshTrack Excludes all other technologies
Reflector Hardware Kit	Included
Server	Excluded
Software	Included HP DL360, Mobile Video Enforcer system server Excludes all other technologies
Subscriber Modules	Excluded
Surge Suppressor/LPU	Includes, PMP (Canopy) Excludes all other technologies
UPS	Excluded
Video Recording System	Excluded from service agreements but may be repaired on an above contract, time and material basis. All UPS Systems must be shipped to IDO for repair. Excludes batteries and any one-site services.
Wireless Router AC and DC Input	Includes Mobile Video Enforcer Excludes all other technologies

Conventional System Infrastructure Exhibit	Inclusions, Exclusions, Exceptions and Notes
Antenna Systems	Excludes all Equipment such as bi-directional amplifiers, multicouplers, combiners, tower top pre-amplifiers, antennas, cables, towers, tower lighting, and transmission lines
Base Station(s) and Repeater(s)	Quantar, Quantro, MTR2000, MTR3000, GTR8000 including IPCCGW. Excludes MICOR and MSF5000
Central Electronics Bank(s)	Includes logging recorder interface and network hub, NICE logging recorders Excludes all other technologies
Channel Bank(s)	Includes Premisys and Telco. Excludes Siemens
Comparator(s)	Includes Spectratrac, Digitac, ASTRO-tac, GMC8000.
Computer(s)	Includes computers (Pentium I, II, III, IV) directly interface with or control the communications System, including Systemwatch II, keyboards, mice and trackballs. Excludes laptop computers and all 286, 386, 486 computers. Excludes defective or phosphor-burned cathode ray tubes CRT(s) and burned-in flat panel display image retention.
Console(s)	Includes Centracom Gold Elite, MCC7500, MCC5500, MIP5000 as part of complete communication System – including headset jacks, dual footswitches, and gooseneck microphones. Excludes cables and Commandstar mother board CDN6271. Commandstar and Commandstar Lite are also excluded as a conventional system operator position but can be covered when services are purchased separately.
Dictaphones, Logging Recorders and Recording Equipment	Includes NICE Excludes all other technologies
Digital Interface Unit(s) (DIU)	Included
Digital Signaling Modem(s)	Included upon modem model availability
Embassy Switch	Includes AEB, AIMI, ZAMBI, AMB
Microwave Equipment.	Excluded from service agreement but may be repaired on an above contract, time and material basis. All equipment must be shipped to IDO. Excludes any on-site services.
Monitor(s)	Includes all Motorola certified monitors connected to computers that directly interface with or control the communications System. Excludes defective or phosphor-burned cathode ray tubes CRT(s) and burned-in flat panel displays image retention as well as monitors not shipped by Motorola and/or cannot be confirmed by a Motorola factory order number.
Moscad	Includes NFM (Network Fault Management), as part of communication System only. Standalone MOSCAD and System Control and Data Acquisition (SCADA) must be quoted separately. Includes FSA4000 Excludes all other fire alarming systems.
Motobridge	Included
Printer(s)	Includes printers that directly interface with the communications System.
Receiver(s)	Includes Quantar , MTR2000, ASTRO-TAC, GPW8000 receivers.
Simulcast Distribution Amplifier(s)	Included
Site Frequency Standard(s)	Includes Rubidium, GPS and Netclocks systems sold with the Motorola System. Excludes MFS -Rubidium Standard Network Time and Frequency devices
Universal Simulcast Controller Interface(s)	Included
UPS Systems.	Excluded from service agreements but may be repaired on an above contract, time and material basis. All UPS Systems must be shipped to IDO for repair. Excludes batteries and any on-site services.

Data System Infrastructure Exhibit	Inclusions, Exclusions, Exceptions and Notes
Base Station(s) and Repeater(s)	Includes Quantar (DSS3, DBS), GTR8000.
Computer(s)	Includes computers (Pentium I, II, III, IV) that directly interface with or control the communications System. Includes keyboards, mice and trackballs. Excludes laptop computers and all 286, 386, 486 computers. Excludes defective or phosphor-burned cathode ray tubes CRT(s) and burned-in flat panel display image retention.
Dictaphones , Logging Recorders and Recording Equipment	Includes NICE Excludes all other technologies
Microwave Equipment.	Excluded from service agreement but may be repaired on an above contract, time and material basis. All equipment must be shipped to IDO. Excludes any on-site services.
Monitor(s)	Includes all Motorola certified monitors connected to computers that directly interface with or control the communications System. Excludes defective or phosphor-burned cathode ray tubes CRT(s) and burned-in flat panel displays image retention as well as monitors not shipped by Motorola and/or cannot be confirmed by a Motorola factory order number.
Printer(s)	Includes printers that directly interface with the communications System.
Radio Network Controller	Includes One (1) RNC and One (1) RNC Console. Redundant RNC's must be quoted separately. Excludes RNC1000, NCP500, NCP2000, NCP2500 and NCP3000.
Site Data Link Modem(s)	Included
UPS Systems.	Excluded from service agreements but may be repaired on an above contract, time and material basis. All UPS Systems must be shipped to IDO for repair. Excludes batteries and any on-site services.
Wireless Network Gateway	Excluded from the prime/remote site or system agreement but can be covered when services are purchased separately.

PlantCML Infrastructure Repair w Advanced Replacement Vesta Pallas, Vesta Standard (Maars/ComCentrex), Vesta Meridian and Sentinel Patriot Systems	Inclusions, Exclusions, Exceptions and Notes
ACU (Auto Control Unit)	Includes Vesta systems only Excludes Sentinel Patriot
ARU (Alarm Reporting Unit)	Included
ALI (Automatic Location Identification) Controller	Includes Analog Station Card(s), Called ID Board(s), Conference Board(s), DTMF Tone Receiver Board(s), Digital Station Card(s), E&M Card(s), Ground Loop Start Card(s), MF Receiver Board(s), 911 Line Card(s)
ANI (Asynchronous Network Interface) Controller	Included
BCM (Business Communication Manager)	Includes Vesta Pallas only Excludes all other technologies
Cable(s)	Excluded
CIM (Console Interface Module)	Includes Sentinel Patriot Excludes all other technologies
CRU (Call Record Unit)	Included
CIU (CAD Interface Unit)	Included
Computer(s)/Workstation	Includes computers sourced by PlantCML and sold by Motorola that directly interface with or control the PlantCML Systems, monitor, sound card, keyboards, mice and trackballs. Excludes defective or phosphor-burned cathode ray tubes (CRT) and burned-in flat panel display image retention.
Controllers	Includes Vesta Standard Excludes all other technologies
DBU (Data Base Unit)	Includes Vesta Standard Excludes all other technologies
Digital Logging Recorders, Logging Recorders and Recording Equipment	Includes NICE, Pyxis, PlantCML sourced and sold by Motorola Excludes all other technologies
Herbie	Includes Vesta systems only Excludes Sentinel Patriot
Line Boosters/Amplifier/Short haul modems	Excluded
Modified Network LAN Switch	Includes
Modem(s)	Includes ALI modem sources and sold by Motorola Excludes all other technologies
Monitor(s)	Includes all Motorola certified monitors connected to computers that directly interface with or control the communications Systems. Excludes Non-Certified monitors, defective or phosphor-burned cathode ray tubes (CRT), flat panel monitors with burned in image retention and monitors not shipped by Motorola and/or cannot be confirmed by a Motorola factory order number.
MTU (Multi-line Trunk Unit)	Includes Vesta Pallas only Excludes All other technologies
Printer(s)	Includes PlantCML sourced and sold by Motorola that directly interface with the communications System
Power Supplies, PSU (Power Supply Unit)	Includes Vesta Pallas, Vesta Standard Excludes all other technologies
RMU (Remote Maintenance Unit)	Includes Vesta Standard only Excludes all other technologies
Ring Generator(s)	Included
Routers	Included
RIS (Radio Interface Subset)	Included (note, only works with the Herbie)
Server(s) ALI	Includes Vesta servers, Sentinel Patriot Excludes all other technologies
Telephone(s)	Includes 911 and KEM administrator telephone sourced with the 911 System and sold by Motorola. Excludes Nortel (Avaya) telephone sets

PlantCML Infrasturcture Repair w Advanced Replacement Vesta Pallas, Vesta Standard (Maars/ComCentrex), Vesta Meridian and Sentinel Patriot Systems cont.	Inclusions, Exclusions, Exceptions and Notes
TIU (Trunk Interface Unit)	Includes Vesta Standard Excludes all other technologies

Console Only Infrastructure Exhibit	Inclusions, Exclusions, Exceptions and Notes
Card Cages	Included
Central Electronics Bank(s) (CEB)	Includes Logging Recorder Interface and Network Hub, NICE logging recorders, Base Interface Module (BIM), Console Operator Interface Module (COIM), Operator Interface Module (OMI).
Central Electronic Shelf (CES)	Included
Computer(s)	Includes computers that directly interface with CEB. Includes keyboards, mice and trackballs. Excludes laptop computers and all 286, 386, 486 computers. Defective or phosphor-burned cathode ray tubes CRT(s) and burned-in flat panel display image retention.
Console(s)	Includes consoles (CommandSTAR, CommandSTAR lite, Centracom Gold Elite MCC7500, MCC7500 w/ VPM, MCC5500, MIP5000, MC1000, MC2000, MC2500, MC3000) as part of complete communication System – Including headset jacks, dual footswitches, and gooseneck microphones and Console Interface Electronics. Excludes cables
Console Audio Box (CAB)	Included
Dictaphones, Logging Recorders and Recording Equipment	Includes NICE Excludes all other technologies
Junction Box	Included
Microwave Equipment.	Excluded from service agreement but may be repaired on an above contract, time and material basis. All Equipment must be shipped to IDO. Excludes any on-site services.
Monitor(s)	Includes all Motorola certified monitors connected to computers that directly interface with or control the communications System. Excludes defective or phosphor-burned cathode ray tubes CRT(s) and burned-in flat panel displays image retention as well as monitors not shipped by Motorola and/or cannot be confirmed by a Motorola factory order number.
Site Frequency Standard(s)	Includes Netclocks systems Excludes MFS -Rubidium Standard Network Time and Frequency devices
UPS Systems.	Excluded from service agreements but may be repaired on an above contract, time and material basis. All UPS Systems must be shipped to IDO for repair. Excludes batteries and any on-site services.

Digital In-Car Video Infrastructure Exhibit	Inclusions, Exclusions, Exceptions and Notes
Cables, connectors and testers	Excluded
Cameras	Includes 22X Front Camera. Excludes rear cameras
Data Talker Wireless Transmitters	Excluded
Digital Video Recorder	Includes Base unit running DP-2 software
Data Storage Module	Included
LCD Monitor	Includes DP-1 & DP-2 versions only
Video Retrieval	It is the customer's responsibility to remove the video before sending the DSM into the Motorola Repair Depot for repair. Video retrieval is a separate service and is excluded from this SOW.

MOTOTRBO Infrastructure Exhibit	Inclusions, Exclusions, Exceptions and Notes
XRC9000 Controller	Included TT2213* single site; TT2215* multi site *Next day (24 hour) delivery if request is received before 1:00 p.m. CST; Second day (48 hour) delivery if request is received after 1:00 p.m. CST
MTR3000	Includes T3000
MIP5000 MOTOTRBO Gateway	Includes L3598

Statement of Work

Network Preventative Maintenance

1.0 Description of Service

Network Preventative Maintenance will provide an operational test and alignment, on the Customer's Infrastructure Equipment (infrastructure or fixed network equipment only) to ensure the Infrastructure meets original manufacturer's specifications, as set forth in the applicable attached Exhibit(s), all of which are hereby incorporated by this reference. Customer's System type determines which Exhibit is applicable (i.e. SmartZone system exhibit, SmartNet system exhibit). Network Preventative Maintenance will be performed during Standard Business Days. If the System or Customer requirements dictate this service must occur outside of Standard Business Days, Motorola will provide an additional quotation. Customer is responsible for any charges associated with helicopter or other unusual access requirements or expenses.

The terms and conditions of this SOW are an integral part of Motorola's Service Terms and Conditions or other applicable agreement to which it is attached and made a part thereof by this reference.

2.0 Motorola has the following responsibilities:

- 2.1 Notify the Customer of any possible System downtime needed to perform this service.
- 2.2 Physically inspect the Infrastructure Equipment in the system (equipment cabinets, general circuitry, fault indicators, cables, and connections).
- 2.3 Remove any dust, and/or foreign substances from the Infrastructure.
- 2.4 Clean filters, if applicable.
- 2.5 Measure, record, align, adjust the Infrastructure Equipment parameters in accordance with the manufacturer's service manuals and the Rules and Regulations of the Federal Communications Commission (FCC), where applicable.

3.0 Customer has the following responsibilities:

- 3.1 Provide preferred schedule for Network Preventative Maintenance to Motorola.
- 3.2 Authorize and acknowledge any scheduled System downtime.
- 3.3 Maintain periodic backup of databases, Software applications and Firmware.
- 3.4 Establish and maintain a suitable environment (heat, light, and power) for the Equipment location and provide the Servicer full, free, and safe access to the Equipment so that the Servicer may provide services. All sites shall be accessible by standard service vehicles.
- 3.5 Cooperate with Motorola and perform all acts that are reasonable or necessary to enable Motorola to provide the Network Preventative Maintenance services to Customer.



Conventional Network Preventative Maintenance Checklist

Conventional Infrastructure	Operational Check (where applicable)
Base Station(s), Repeater(s), Control Station(s)	Transmitter modulation,
	RF power output/reflected
	RF Frequency Measured/adjusted
	Receiver Sensitivity Measured/Adjusted
	Audio Input & Output Levels
	Combiner & Circulator Loss
	Receiver Desense (Full Duplex Only)
	Check Power Supply Voltages
Consoles Positions/Remotes	Audio Input & Output Levels
	Ethernet Operation
	Controller Power Supply Voltage, and AC Ripple
	Switches, Lights, CRT
	CEB Signal Levels
	Wiring and Grounding for each Position
	Check and Clean keyboards, CPU. CRT's
	CEB diagnostics
Comparators (Voting) and /or Satellite Receivers	Audio Input & Output Levels
	Receiver Sensitivity Measured/Adjusted
	Comparator power supply voltage
	Check for proper signal voting
Power UPS	Check Diagnostics/Alarms
	AC/DC Voltages/Batteries
	Switch-Over Operations
Generator	Switch to Generator Power
AC to DC Power Unit (RF equipment)	Switch to Battery Power
All Equipment	Check Diagnostics/Alarms
Other Equipment	Check all system printers
	Check all modems for proper levels & synchronization
	MBX/Other telco interface common equipment



Data – Network Preventative Maintenance Checklist

Data Infrastructure	Operational Check (where applicable)
Data Base Station (Quantar)	RSSI Calibration Check (-90)
	Transmit Frequency Adjustments
	Transmitter Deviation Adjustments
	Transmitter modulation Compensation
	Transmitter Power out and Adjustments
	Reflect Power Measurement
	Receiver Sensitivity Test
	Receive Antenna De-sense Test
MSF 5000 Base Stations	RSSI Calibration Check
	VCO Calibration Check (.38Micro Volt)
	Injection Filter Adjustments
	Pre-selector/Image Filter Adjustments
	Transmit Frequency Adjustments
	RF Power out Measurements
	RF Forward and Reflect Trip adjust
	Transmit Deviation Adjustments
	Receiver Sensitivity Test
	Transmitter modulation Compensation
Gemini Base Station	RSSI Calibration Check
	Transmit Frequency Adjustments
	RF Power out Measurements
	RF Forward and Reflect Trip adjust
	Transmit Deviation Adjustments
	Receiver Sensitivity Test
	Transmitter modulation Compensation
	Power Supply Voltage Check
	Power Supply Ripple Voltage Check
Radio Network Controllers	Power Supply In-take Fan
	Host connection check
	Message buffering
	RF Interface
	Base Interface
Wireless Network Gateway	Visually check system status and fault LEDs.
	Check SMIT for any module errors.
	Check each major modules
	Power Supply Voltage Check
	Visually check all cabling
	Capture all log and error reports
UDS/Paradyne Modems	Check for received line level
	Perform remote modem digital loopback test
	Check telco/microwave circuit
UPS	Check Batteries
	Switch-Over Operations
	AC/DC Voltages



SMARTNET Network Preventative Maintenance Checklist

SMARTNET Infrastructure	Operational Check (where applicable)
Repeater(s), Control Station(s)	Transmitter modulation,
	RF power output/reflected
	RF Frequency Measured/adjusted
	Receiver Sensitivity Measured/Adjusted
	Power Supplies
	Audio Input & Output Levels
	Combiner & Circulator Loss
	Receiver Desense (Full Duplex Only)
Consoles Positions/Remotes	Check Power Supply Voltages
	Audio Input & Output Levels
	Ethernet Operation
	CEB Power Supply Voltage, and AC Ripple
	Switches, Lights, CRT
	CEB Signal Levels
	Wiring and Grounding for each Position
	Check and Clean keyboards, CPU. CRT's
Central Controllers, DIGITAC Comparators	CEB Diagnostics
	Central Controller and Power Supplies
	T Bar Switched
	Simulcast Controller
	Simulcast Remote Controller
	Distribution Amp
	DIGITAC Comparator
	Receiver Multi-Couplers
	Check for receiver to Comparator audio path. Check to see if equalization is required.
	Check for proper audio to Status Tone ratio
Confirm that all Receiver RX Notch Filters are either IN or OUT	
GPS	Roll to Redundant Receive Reference Module
	Frequency Standards (check 1 PPS, 5 MPPS, composite)
	Check Power Supply Voltages
Site Equipment	Audio Network Analyzer
	Baseline Database Server
	System Manager Terminal
	Site Test/System Calibration Equipment
POWER UPS	Check Diagnostics/Alarms
	AC/DC Voltages/Batteries
	Switch-Over Operations
Generator	Switch to Generator Power
AC to DC Power Unit (RF equipment)	Switch to Battery Power
All Equipment	Check Diagnostics/Alarms
Other Equipment	Check all system printers
	Check all modems for proper levels & synchronization
	MBX/Other telco interface common equipment



SmartZone -Network Preventative Maintenance Checklist

SmartZone Infrastructure	Operational Check (where applicable)	
Repeater(s), Control Station(s)	Transmitter modulation	
	RF power output/reflected	
	RF Frequency Measured/adjusted	
	Receiver Sensitivity Measured/Adjusted	
	Audio Input & Output Level	
	Check Low Speed Data	
	Combiners & Circulator Loss	
	Receiver Desense (Full Duplex Only)	
Consoles Positions/Remotes	Power Supply voltages	
	Audio Input & Output Level	
	Ethernet Operation	
	CEB Power Supply Voltage, and AC Ripple	
	Switches, Lights, CRT	
	CEB Signal Levels	
	Wiring and Grounding for each Position	
	Check and Clean keyboards, CPU. CRT's	
Central Controllers, DIGITAC Comparators	CEB Diagnostics	
	Central Controller and Power Supplies	
	T Bar Switched	
	Simulcast Controller	
	Simulcast Remote Controller	
	Distribution Amp	
	DIGITAC Comparator	
	Receiver Multi-Couplers and Tower Mounted Amplifier	
	Check for receiver to Comparator audio path.	
	Check for proper audio to Status Tone ratio	
GPS	Confirm that all Receiver RX Notch Filters are either IN or OUT	
	Roll to Redundant Receive Reference Module	
	Check Frequency Standards	
Site Equipment	Check Power Supply Voltages	
	Audio Network Analyzer	
	Baseline Database Server	
	System Manager Terminal	
Power UPS	Site Test/System Calibration Equipment	
	Check Diagnostics/Alarms	
	AC/DC Voltages/Batteries	
	Switch-Over Operations	
	Generator	
		Switch to Generator Power
Switch to Battery Power		
AC to DC Power Unit (RF equipment)		
	Check Diagnostics/Alarms	
All Equipment	Check all system printers	
	Check all modems for proper levels & synchronization	
	MBX/Other telco interface common equipment	



ASTRO® LE -Network Preventative Maintenance Checklist

Astro LE Infrastructure	Operational Check (where applicable)
CO-LOCATED/REMOTE SITE Repeater(s), Control Station(s) Site Controllers Router/Switches All Equipment	
	TX Frequency in Hz
	TX Power Output of Station (Forward/Reflected)
	TX Power Output out of Combiner (Forward/Reflected)
	TX Low Speed Deviation
	TX Test Pattern Deviation
	TX BER
	RX Tower/Rack Mounted Amplifier
	RX RF Level at 5% BER at Receiver and Through Multi-Coupler
	Receiver Desense/ Degradation do to Site Noise and TX Desense
	Wireline Audio Input & Output Levels
	Check Lights/Fan Operation
	Check/Align Frequency Standard
	Roll to Redundant Controller (pre-approved by customer)
Test Site Trunking/Failsoft Modes (pre-approved by customer)	
Multiple Control Channel Switching (pre-approved by customer)	
Check Lights/Fan Operation	
Check Diagnostics/Alarms	
Power Supply Voltages	
MASTER/PRIME SITE (RF Equipment) Master/Prime Site Controllers Router/Switches ASTRO-TAC Comparators Channel Bank	
	Check Lights/Fan Operation
	Roll to Redundant Controller (pre-approved by customer)
	Check Lights/Fan Operation
	Check for receiver to Comparator audio path
ACTAC 9600 Comparator All sites on line? V.24 link health-link delays	
Channel Bank/ transport health for all sites (diagnostics/alarms)	
Roll to Redundant Power Supply (pre-approved by customer)	
MASTER/PRIME SITE (Servers)	Site Control Manager/Site Command Server (Clients)
	Backup Databases
	Terminal Server
	Remote Access Test
GPS	Roll to Redundant Receive Reference Module (pre-approved by customer)
	Frequency Standards (check 1 PPS, 5 MPPS, composite)
	Check Power Supply Voltages
POWER UPS Generator	Check Diagnostics/Alarms
	AC/DC Voltages/Batteries
	Switch-Over Operations
	Switch to Generator Power (pre-approved by customer)



AC to DC Power Unit (RF equipment)	Switch to Battery Power (pre-approved by customer)
	Check Diagnostics/Alarms
All Equipment	
TRUNKING TEST (Completed at all Sites)	Talkgroup Call
	Multigroup Call
	Private Call
	Secure Call



ASTRO® 25 ARC4000, 6.x, & 7.x Network Preventative Maintenance Checklist

ASTRO® 25 ARC4000, 6.x, & 7x	Operational Check (where applicable) Reference existing site PM documents for exact measurements
CO-LOCATED/REMOTE SITE Repeater(s), Control Station(s)	
	TX Frequency in Hz
	TX Power Output of Station (Forward/Reflected)
	TX Power Output out of Combiner (Forward/Reflected)
	TX Low Speed Deviation
	TX Test Pattern Deviation
	TX BER
	RX Tower/Rack Mounted Amplifier
	RX RF Level at 5% BER at Receiver and Through Multi-Coupler
	Receiver Desense/ Degradation do to Site Noise and TX Desense
	Wireline Audio Input & Output Levels
Site Controllers	Check Lights/Fan Operation
	Check/Align Frequency Standard
	Roll to Redundant Controller (pre-approved by customer)
	Test Site Trunking/Failsoft Modes (pre-approved by customer)
	Multiple Control Channel Switching (pre-approved by customer)
Router/Switches	Check Lights/Fan Operation
All Equipment	Check Diagnostics/Alarms
	Power Supply Voltages
MASTER/PRIME SITE (RF Equipment)	
Master/Prime Site Controllers	Check Lights/Fan Operation
	Roll to Redundant Controller (pre-approved by customer)
Router/Switches	Check Lights/Fan Operation
ASTRO-TAC Comparators	Check for receiver to Comparator audio path
	ACTAC 9600 Comparator All sites on line? V.24 link health- link delays
Channel Bank	
	Channel Bank/ transport health for all sites (diagnostics/alarms)
	Roll to Redundant Power Supply (pre-approved by customer)
MASTER/PRIME SITE (Servers)	
Misc Equipment	Master Site Servers health (diagnostics/alarms)
	Complete backup of databases
	Roll to Redundant Zone Controller (pre-approved by customer)
	Remote Access Test
	Check all modems for proper levels & synchronization
	MBX/Other telco interface common equipment
GPS	
	Roll to Redundant Receive Reference Module (pre-approved by customer)
	Frequency Standards (check 1 PPS, 5 MPPS, composite)
	Check Power Supply Voltages
POWER	
UPS	Check Diagnostics/Alarms
	AC/DC Voltages/Batteries
	Switch-Over Operations
Generator	Switch to Generator Power (pre-approved by customer)
AC to DC Power Unit (RF equipment)	Switch to Battery Power (pre-approved by customer)
All Equipment	Check Diagnostics/Alarms



CONSOLES POSITIONS/REMOTES	Audio Input & Output Level
	Ethernet Operation
	CEB/MCC Power Supply Voltage, and AC Ripple
	Switches, Lights, CRT
	CEB/MCC Signal Levels
	Wiring and Grounding for each Position
	Check and Clean keyboards, CPU. CRT's
	CEB/AEB/MCC diagnostics
TRUNKING TEST (Completed at all sites)	Talkgroup Test
	Multigroup Call
	Private Call
	Secure Call



E911 System Exhibit

Infrastructure Type	Operational Check (when applicable)
ANI Controller	Power supply check -DC Voltage
	Processor card battery test
	Review of advisory log
	Inspect phone, handsets, cords, touch tone pads, lights, and telephone instruments at main PSAP and remote location.
	Test operation of each 911 trunk and administrative phone line
	Check ANI cable routing and verify all connections (tighten cable/connector strain relief devices, review punch block wiring)
	Verify dial-up access
	Verify any spare circuit boards are operational
	Inspect ANI cabinets (ventilation/cooling, secure covers)
ALI Controller	Verify no alarm status on call screen. Check alarm/event log
	Check size of call detail records, purge if necessary
	Size of hard space remaining and advise customer. Purge if necessary.
	Test operation of all servers, terminals/clients printers, at main PSAP and remote locations
	Make test 911 calls to verify ALI information is properly displayed on all terminals/clients at main PSAP and remote locations
	Verify any spare ALI equipment or devices are operational
	If system uses local ALI or TSL, verify system properly receives Telco subscriber updates as required
	Check ALI cable routing and verify all connections (tighten cable/connector strain relief devices where necessary)
	Inspect all computer and terminal equipment (fans, vents, keyboards, CRTs, etc) .
	Verify ALI components are receiving proper ventilation/cooling
	Other
Verify inbound remote maintenance access of both ANI and ALI functions through all remote access devices (SEB or maintenance modems)	
Check and verify proper installation of all grounding cables and connectors.	
Verify operational status of surge suppression equipment	
Verify operational status of standby power systems (UPS equipment, AC generators)	

Statement of Work

OnSite Infrastructure Response and Dispatch Service

1.0 Description of Services

The Motorola System Support Center (SSC) will receive Customer request for service and dispatch a Servicer. For Mesh system a Servicer will be dispatched only to the central site where the Mobile Integrated System Controller (MISC) is located. The Servicer will respond to the Customer location based on pre-defined Severity Levels set forth in the Severity Definitions Table and Response times set forth in the Response Time Table in order to Restore the System.

Motorola will provide Case management as set forth herein. The SSC will maintain contact with the on-site Servicer until System Restoral and Case is closed. The SSC will Continuously track and manage Cases from creation to close through an automated Case tracking process. This Case management allows for Motorola to provide Case activity reports.

The terms and conditions of this Statement of Work (SOW) are an integral part of Motorola's Service Terms and Conditions or other applicable Agreement to which it is attached and made a part thereof by this reference.

2.0 Motorola has the following responsibilities:

- 2.1. Continuously receive service requests.
- 2.2. Create a Case as necessary when service requests are received. Gather information to perform the following:
 - 2.2.1. Characterize the issue.
 - 2.2.2. Determine a plan of action.
 - 2.2.3. Assign and track the Case to resolution.
- 2.3. Dispatch a Servicer as required by Motorola standard procedures and provide necessary Case information collected in 2.2.
- 2.4. Ensure the required personnel have access to Customer information as needed.
- 2.5. Servicer will perform the following on-site:
 - 2.5.1. Run diagnostics on the Infrastructure or FRU.
 - 2.5.2. Replace defective Infrastructure or FRU, as applicable. Customer, Servicer or Motorola may provide Infrastructure or FRU.
 - 2.5.3. Provide materials, tools, documentation, physical planning manuals, diagnostic/test equipment and any other requirements necessary to perform the Maintenance service.
 - 2.5.4. If a third party Vendor is needed to Restore the System, the Servicer may accompany that Vendor onto the Customer's premises.
- 2.6. Verify with Customer that Restoration is complete or System is functional, if required by Customer's repair Verification in the Customer Support Plan required by section 3.2. If Verification by Customer cannot be completed within 20 minutes of Restoration, the Case will be closed and the Servicer will be released.
- 2.7. Escalate the Case to the appropriate party upon expiration of a Response time.
- 2.8. Close the Case upon receiving notification from Customer or Servicer, indicating the Case is resolved.
- 2.9. Notify Customer of Case Status as defined required by the Customer Support Plan:
 - 2.9.1. Open and closed; or
 - 2.9.2. Open, assigned to the Servicer, arrival of the Servicer on-site, deferred or delayed, closed.
- 2.10. Provide Case activity reports to Customer.

3.0 Customer has the following responsibilities:

- 3.1. Contact Motorola, as necessary, to request service Continuously.
- 3.2. Provide Motorola with pre-defined Customer information and preferences prior to Start Date necessary to complete Customer Support Plan.
 - 3.2.1. Case notification preferences and procedure.

- 3.2.2. Repair Verification preference and procedure.
- 3.2.3. Database and escalation procedure forms.
- 3.2.4. Submit changes in any information supplied in the Customer Support Plan to the Customer Support Manager.
- 3.3. Provide the following information when initiating a service request:
 - 3.3.1. Assigned System ID number.
 - 3.3.2. Problem description and site location.
 - 3.3.3. Other pertinent information requested by Motorola to open a Case.
- 3.4. Allow Servicicers access to Equipment.
- 3.5. Supply Infrastructure or FRU, as applicable, in order for Motorola to Restore the System as set forth in paragraph 2.5.2.
- 3.6. Maintain and store in an easily accessible location any and all Software needed to Restore the System.
- 3.7. Maintain and store in an easily accessible location proper System backups.
- 3.8. For E911 systems, test the secondary/backup PSAP connection to be prepared in the event of a catastrophic failure of a system. Train appropriate personnel on the procedures to perform the function of switching to the backup PSAP.
- 3.9. Verify with the SSC that Restoration is complete or System is functional, if required by Repair Verification preference provided by Customer in accordance with section 3.2.
- 3.10. Cooperate with Motorola and perform all acts that are reasonable or necessary to enable Motorola to provide these services.

Severity Definitions Table

Severity Level	Problem Types
Severity 1	<ul style="list-style-type: none"> ▪ Response is provided Continuously ▪ Major System failure ▪ 33% of System down ▪ 33% of Site channels down ▪ Site Environment alarms (smoke, access, temp, AC power). ▪ This level is meant to represent a major issue that results in an unusable system, sub-system, Product, or critical features from the Customer's perspective. No Work-around or immediate solution is available.
Severity 2	<ul style="list-style-type: none"> ▪ Response during Standard Business Day ▪ Significant System Impairment not to exceed 33% of system down ▪ System problems presently being monitored ▪ This level is meant to represent a moderate issue that limits a Customer's normal use of the system, sub-system, product, or major non-critical features from a Customer's perspective
Severity 3	<ul style="list-style-type: none"> ▪ Response during Standard Business Day ▪ Intermittent system issues ▪ Information questions ▪ Upgrades/Preventative maintenance ▪ This level is meant to represent a minor issue that does not preclude use of the system, sub-system, product, or critical features from a Customer's perspective. It may also represent a cosmetic issue, including documentation errors, general usage questions, recommendations for product enhancements or modifications, and scheduled events such as preventative maintenance or product/system upgrades.

Response Times Table (Customer's Response Time Classification is designated in the Service Agreement)

Severity Level	Standard Response Time	Premier Response Time	Limited Response Time	Restoral	Off Deferral
Severity 1	Within 4 hours from receipt of Notification Continuously	Within 2 hours from receipt of Notification Continuously	Within 4 hours from receipt of Notification Standard Business Day	8 hours	Time provided by Servicer *
Severity 2	Within 4 hours from receipt of Notification Standard Business Day	Within 4 hours from receipt of Notification Standard Business Day	Within 4 hours from receipt of Notification Standard Business Day	8 hours	Time provided by Servicer *
Severity 3	Within 24 hours from receipt of Notification Standard Business Day	Within 24 hours from receipt of Notification Standard Business Day	Within 24 hours from receipt of Notification Standard Business Day	48 hours	Time provided by Servicer *

- Please note these are Standard Commitment times. The commitment times should be based on the Customers Support Plan.
 - Provide update **before** the specific contractual commitments come due.
- * Note: Provide update to System Support Center **before** Deferral time comes due.



Statement of Work

Security Update Service (SUS)

1.0 Definitions

Terms that are capitalized but not defined in this Statement of Work shall have the definition given to such terms in the Service Terms and Conditions, the Communications System Agreement or other applicable agreement. The following terms have the following meanings:

1.1 Non-Motorola Software: Software whose copyright is owned by a party other than Motorola or its affiliated company, including but not limited to the anti-virus definitions, operating system software patches and signature files that will be pre-tested pursuant to this Statement of Work.

1.2 System: The currently shipping Motorola ASTRO[®] 25 System Release and up to 5 releases prior.

1.3 Supported Release: Security Update Service is available on the currently shipping Motorola ASTRO[®] 25 System Release and up to 5 releases prior. If a customer is on a System Release outside of the N-5 release schedule, then they cannot purchase this service.

2.0 Description of Services

With Security Update Service (“Service”), Motorola pretests the updated commercial anti-virus definitions for the Microsoft Windows based boxes on a System. This Service includes Motorola obtaining Microsoft Security Updates for Windows operating system, Solaris recommended patch bundles, Red Hat Linux security patches, anti-virus definitions* and intrusion detection sensor updates for Motorola supplied equipment from applicable original equipment manufacturer (OEM).

Motorola will evaluate and pre-test each update on Motorola’s ASTRO 25 test System components for operational impact. Motorola’s verification and evaluation process for anti-virus definitions will consist of applying each update to an appropriate ASTRO 25 system release that corresponds and is consistent with supported** and fielded systems.

Each assessment will consist of no less than 36 hours of examination time to evaluate the impact each anti-virus update has to the system. Upon satisfactory completion of the assessment pertaining to anti-virus signatures, these updates will be provided on a weekly basis either automatically or through connecting to Motorola’s secured extranet connection. When anti-virus definitions classified as Category 4 (Severe, difficult to contain) and Category 5 (Very Severe, very difficult to contain) by the commercial



supplier are released, Motorola will determine if a high-priority release is necessary. Operating system updates/patches will be made available to our customers electronically upon successful testing in our lab environments on a monthly basis for Microsoft patches and on a quarterly basis for all others.

NOTICE: If a customer wants antivirus and IDS updates automatically deployed onto their network, then they must purchase the Security Monitoring service. Otherwise, customers may download the updates from the secure extranet site and manually deploy them onto their network. Motorola will perform testing only on standard configurations certified by Motorola System Integration Testing (SIT) and Motorola supplied equipment/software prior to making an update available to Customers.

* - Not all systems are provided antivirus for Microsoft and UNIX platforms. To receive full antivirus support under this service offering, the customer must have a standard ASTRO 25 system that is supported and also has implemented antivirus for UNIX.

** - Supported is defined as the current system release and the last five prior. Support beyond this model requires approval from the Customer Service Manager and the Security Services Product Manager. For extended coverage, please communicate a formal request to your account manager.

The customer will be responsible for deploying Microsoft, Oracle, Sun Microsystems, UNIX, and Linux security updates from a Motorola provided secured extranet Web site. Antivirus and IDS updates will be capable of being pushed automatically to the customer ASTRO25 network only if the Security Monitoring service is purchased by the customer. If there is a recommended configuration change that is successfully tested on the ASTRO 25 test System, Motorola will provide detailed instructions for performing the configuration change.

Inclusions: Security Update Service is available on the currently shipping Motorola ASTRO 25 System Release and up to 5 releases prior. If a customer is on a System Release outside of the N-5 release schedule, then they cannot purchase this service.

Exclusions: Systems that have non-standard configurations that have not been certified by Motorola SIT are specifically excluded from this Service unless otherwise agreed in writing by Motorola. Service does not include pre-tested intrusion detection system (IDS) updates for IDS solutions not purchased through Motorola. NICE Recorder, certain consoles, MARVLIS, Symbol Equipment, AirDefense Equipment, AVL, and Radio Site Security products are also excluded. The scope of service coverage is defined by Motorola Services and is subject to change based on OEM support lifecycles. The terms and conditions of this Statement of Work are an integral part of Motorola's Service Terms and Conditions or other applicable Agreement to which it is attached and made a part thereof by this reference.



3.0 Motorola has the following responsibilities:

3.1 Obtain anti-virus definitions for the Microsoft Windows platform, intrusion detection sensor signatures for Motorola supplied IDS, Microsoft Security Updates for Windows Operating system, Solaris operating system recommended patch bundles, and Red Hat Linux security patches from Motorola selected commercial suppliers.

3.2 Evaluate anti-virus definitions classified as Category 4 and 5 by Motorola selected commercial supplier to determine if a high-priority release is required. Motorola in its discretion will determine the urgency of the update based on the impact to the System.

3.3 Identify and document latest System vulnerabilities and compliance issues discovered during quarterly vulnerability scan performed in Section 3.4.

3.4 Investigate new vulnerabilities and compliance issues that are identified. Recommended response may include, but is not limited to, ASTRO 25 Systems, deploy security software updates; deploy operating system security updates or patches; implement configuration changes; upgrade to current ASTRO 25 System Release (actual upgrade expense not included in this service offering); or recommending a compensating control.

3.5 Pre-test recommended remediation when applicable and make documentation and/or software updates available to Customer electronically.

3.6 Provide documented response with recommended remediation when applicable for all new vulnerabilities quarterly or at Motorola's discretion to Customer electronically.

3.7 Test anti-virus definitions, intrusion detection sensor signatures, and operating system security updates/patches by deploying them on a dedicated ASTRO 25 test System with the standard supported configurations, which include Motorola's then current approved cohabitated applications.

3.8 Confirm that tested anti-virus definitions, intrusion detection sensor signatures, and operating system security updates/patches do not degrade or compromise System functionality on dedicated test System within the standard supported configurations.

3.9 Address issues identified during testing to support functionality under the procedures specified in 3.8 above by working with Motorola selected commercial supplier or Motorola product development engineering team.

3.10 Release pre-tested anti-virus definitions and intrusion detection sensor signatures for Motorola supplied IDS electronically on a weekly basis upon successful completion of the weekly test cycle to be completed one week after release by commercial supplier unless an issue is detected or within 36 hours from Motorola selected commercial supplier's Category 4 & 5 certified virus definitions being available or at Motorola's discretion if determined by Motorola to be a high-priority release. Release may include



the anti-virus definition file, intrusion detection sensor signatures, updated configuration files, instructions and other information deemed pertinent by Motorola.

3.11 Release Microsoft, Solaris and Red Hat Linux operating system security patches/updates when they are certified and available with instructions for obtaining patch/update for Customer deployment on the Customer system. Microsoft operating system security updates will be released monthly as available from Motorola selected commercial supplier upon successful completion of monthly test cycle. Solaris and Red Hat Linux operating system security patches will be released quarterly upon successful completion of quarterly test cycle or at Motorola's discretion.

3.12 Notify Customer when the latest release is available with instructions on where to obtain latest release.

3.13 Provide technical assistance if there is an issue with the installation of an update.

3.14 Maintain annual Customer subscriptions for anti-virus definitions and intrusion detection sensor signatures, with Motorola selected commercial supplier.

4.0 Customer has the following responsibilities:

4.1 Provide means for accessing pre-tested files electronically.

4.2 Deploy pre-tested files on Customer System as instructed in the "Read Me" text provided.

4.3 Implement recommended remediation(s) on Customer System as determined necessary by Customer.

4.4 Upgrade System to a Supported System Release as necessary to continue Service.

4.5 Identify one point of contact for issues specific to Security Update Service.

4.6 Cooperate with Motorola and perform all acts that are reasonable and/or necessary to enable Motorola to electronically provide Security Update Service – Platinum to Customer.

4.7 Comply with the terms of the applicable license agreement between Customer and the Non-Motorola Software copyright owner.

4.8 Adhere closely to the System Support Center (SSC) troubleshooting guidelines provided upon system acquisition. A failure to follow SSC guidelines may cause Customer and Motorola unnecessary or overly burdensome remediation efforts that may result in a service fee to Customer.



5.0 WARRANTIES AND DISCLAIMER:

Motorola warrants that its services will be free of defects in materials and workmanship for a period of ninety (90) days following completion of the service. Your sole remedies are to require Motorola to re-perform the affected service or at Motorola's option to refund, on a pro-rata basis, the service fees paid for the affected service.

During the applicable Warranty Period, Motorola warrants that the tested anti-virus definitions, intrusion detection sensor signatures, and operating system security updates/patches do not degrade or compromise System functionality, and that after incorporation of the recommended remediation action the System Software, when used properly and in accordance with the Documentation, will be free from a reproducible defect that eliminates the functionality or successful operation of a feature critical to the primary functionality or successful operation of the Software. Product and Software documentation that specifies technical and performance features and capabilities, and the user, operation and training manuals for the Software (including all physical or electronic media upon which this information is provided) are collectively referred to as "Documentation." Whether a defect occurs will be determined solely with reference to the Documentation. Motorola does not warrant that Customer's use of the Software or Products will be uninterrupted or error-free or that the Software or the Products will meet Customer's particular requirements.

MOTOROLA DISCLAIMS ALL OTHER WARRANTIES WITH RESPECT TO PRE-TESTED ANTI-VIRUS DEFINITIONS, DATABASE SECURITY UPDATES, OPERATING SYSTEM SOFTWARE PATCHES, AND INTRUSION DETECTION SENSOR SIGNATURE FILES, EXPRESS OR IMPLIED, INCLUDING THE IMPLIED WARRANTIES OF MERCHANTABILITY, FITNESS FOR A PARTICULAR PURPOSE, AND NON-INFRINGEMENT. FURTHER, MOTOROLA DISCLAIMS ANY WARRANTY CONCERNING THE NON-MOTOROLA SOFTWARE AND DOES NOT GUARANTEE THAT CUSTOMER'S SYSTEM WILL BE ERROR-FREE OR IMMUNE TO VIRUSES OR WORMS AS A RESULT OF THESE SERVICES.



Statement of Work

Technical Support Service

1.0 Description of Services

The Technical Support service provides centralized remote telephone support for technical issues that require a high level of communications systems expertise or troubleshooting on Equipment. The Motorola System Support Center's (SSC) Technical Support Operation is staffed with technologists who specialize in the diagnosis and resolution of system performance issues. Technical Support Service: (i) does not include software upgrades that may be required for issue resolution; (ii) does not include Customer training; (iii) is only available for those system types supported and approved by Technical Support Operations and (iv) limited to Infrastructure currently supported by Motorola,

Technical Support is applicable to the following system types: ASTRO®, ASTRO® 25, ARC 4000, SmartZone® v2.0.3 and higher, SmartZone®/OmniLink®, E911, Private Data v2.0.3 and higher, SmartNet®, Conventional Two-Way, Wireless Broadband and Digital In-Car Video.

The terms and conditions of this Statement of Work (SOW) are an integral part of Motorola's Service Terms and Conditions or other applicable Agreement to which it is attached and made a part thereof by this reference.

2.0 Motorola has the following responsibilities:

- 2.1. Respond to requests for Technical Support for the Restoration of failed Systems and diagnosis of operation problems in accordance with the response times set forth in the Remote Technical Support Response Times Table and the Severity Level defined in the Severity Definitions Table.
 - 2.1.1. If Infrastructure is no longer supported by Motorola, Technical Support will diagnosis the System but may not be able to resolve the issue without the Customer replacing the Infrastructure.
- 2.2. Advise caller of procedure for determining any additional requirements for issue characterization, and Restoration which includes providing a known fix for issue resolution when available.
- 2.3. Attempt remote access to System for remote diagnostics, when possible.
- 2.4. Maintain communication with the Servicier or Customer in the field until close of the Case, as needed.
- 2.5. Coordinate technical resolutions with agreed upon third party Vendor(s), as needed.
- 2.6. Escalate and manage support issues, including Systemic issues, to Motorola engineering and product groups, as applicable.
- 2.7. Escalate the Case to the appropriate party upon expiration of a Response time.
- 2.8. Provide Configuration Change Support and Work Flow changes to Systems that have dial in or remote access capability.
- 2.9. Determine, in its sole discretion, when a Case requires more than the Technical Support services described in this SOW and notify Customer of an alternative course of action.

3.0 Customer has the following responsibilities:

- 3.1. Provide Motorola with pre-defined information prior to Start Date necessary to complete Customer Support Plan.
 - 3.1.1. Submit changes in any information supplied in the Customer Support Plan to the Customer Support Manager.
- 3.2. Contact the SSC in order to access the Technical Support Operation, provide name of caller, name of Customer, System ID number, Service Agreement number, site(s) in questions, and brief description of the problem.
- 3.3. Supply on-site presence when requested by System Support Center.
- 3.4. Validate issue resolution prior to close of the Case.



- 3.5. Allow Motorola remote access to the System by equipping the System with the necessary Connectivity.
- 3.6. Remove video from Digital In-Car Video equipment prior to contacting Motorola. If Technical Support assists the Customer in removing video, the Customer acknowledges, understands and agrees that Motorola does not guarantee or warrant that it will be able to extract any captured video or that any captured video will not be damaged, lost or corrupted.
- 3.7. Acknowledge that Cases will be handled in accordance with the times and priorities as defined in Remote Technical Support Response Times Table and the Severity Level defined in the Severity Definitions Table.
- 3.8. Cooperate with Motorola and perform all acts that are reasonable or necessary to enable Motorola to provide the Technical Support service to Customer.

Severity Definitions Table

Severity Level	Problem Types
Severity 1	<ul style="list-style-type: none"> ▪ Response is provided Continuously ▪ Major System failure ▪ 33% of System down ▪ 33% of Site channels down ▪ Site Environment alarms (smoke, access, temp, AC power). ▪ This level is meant to represent a major issue that results in an unusable system, sub-system, Product, or critical features from the Customer's perspective. No Work-around or immediate solution is available.
Severity 2	<ul style="list-style-type: none"> ▪ Response during Standard Business Day ▪ Significant System Impairment not to exceed 33% of system down ▪ System problems presently being monitored ▪ This level is meant to represent a moderate issue that limits a Customer's normal use of the system, sub-system, product, or major non-critical features from a Customer's perspective
Severity 3	<ul style="list-style-type: none"> ▪ Response during Standard Business Day ▪ Intermittent system issues ▪ Information questions ▪ Upgrades/preventative maintenance ▪ This level is meant to represent a minor issue that does not preclude use of the system, sub-system, product, or critical features from a Customer's perspective. It may also represent a cosmetic issue, including documentation errors, general usage questions, recommendations for product enhancements or modifications, and scheduled events such as preventative maintenance or product/system upgrades.

Remote Technical Support Response Times Table

SEVERITY	RESPONSE
Severity 1	Within 1 Hour from receipt of Notification, Continuously
Severity 2	Within 4 Hours from receipt of Notification, Standard Business Day
Severity 3	Within next Business Day, Standard Business Day

STATEMENT OF WORK

ASTRO 25 SYSTEM UPGRADE AGREEMENT II (SUA II)

1.0 Description of Service and Obligations

- 1.1 As major system releases become available, Motorola agrees to provide the system owner with the software, hardware and implementation services required to execute up to one system infrastructure upgrade in a two-year period for their ASTRO 25 system. Additionally, if purchased, the Security Update Service (SUS) coverage is defined in Appendix C.
- 1.2 The parties agree that the system owner will have, at their option, the choice of upgrading in either Year 1 or Year 2 of the coverage period. To be eligible for the ASTRO 25 System Upgrade Agreement II, the ASTRO 25 system must be at system release 7.7 or later.
- 1.3 Motorola agrees to provide minor software upgrades, known as “patch releases”, which may include commercial Operating Software (“OS”) and application software patches and service pack updates when and if available. Currently, the parties acknowledge that Motorola’s service includes Microsoft Windows and Server OS, Red Hat Linux, Sun Solaris and any Motorola software service packs that may be available. Motorola agrees to provide only patch releases that have been analyzed, pre-tested, and certified in a dedicated ASTRO 25 test lab to ensure that they are compatible and do not interfere with the ASTRO 25 network functionality. Corresponding 3rd Party software and operating system patches will be released quarterly upon successful completion of the regular test cycle or at Motorola’s discretion. Once a patch release has been validated as safe for deployment on the radio network, Motorola agrees to post it on a Motorola secure extranet site for the Customer to download and deploy.
 - 1.3.1 The parties agree that minor software upgrades, and patch release coverage, which include commercial OS and application software patches and service pack updates, will terminate should the customers system release version become more than 5 system release versions from the current shipping release version.
- 1.4 The parties agree that ASTRO 25 system release upgrades are considered “major” upgrades if they include commercial OS and application software updates as well as Motorola system release software. System releases shall be pre-tested and certified in Motorola’s Systems Integration Test lab. ASTRO 25 system releases shall improve the system functionality and operation from previous releases and may include some minor feature enhancements. At Motorola’s option, system releases may also include significant new feature enhancements as optional features. The SUA II does not include coverage for new optional feature software or hardware. Optional features may be offered for purchase.
- 1.5 The parties agree to the Eligible System Release Upgrade Paths available to the system owner as per the system release upgrade chart referenced and incorporated in Appendix A.
- 1.6 Motorola agrees that this Agreement entitles a Customer to past software versions for the purpose of downgrading product software to a compatible release version.

- 1.7 Motorola agrees that the following ASTRO 25 system release software for the following products are covered under this Agreement: base stations, site controllers, comparators, routers, LAN switches, servers, dispatch consoles, NICE IP logging recorder, NICE replay stations (Scenario Replay and Inform Lite), network management terminals, Network Fault Management (NFM) products, network security devices such as firewalls and intrusion detection sensors, and associated peripheral infrastructure software.
- 1.8 Product programming software such as Radio Service Software (“RSS”), Configuration Service Software (“CSS”), and Customer Programming Software (“CPS”) are also covered under this Agreement.
- 1.9 The parties agree that the SUA II makes available the subscriber radio software releases that are shipping from the factory during the SUA II coverage period. The parties further agree that new subscriber radio options and features not previously purchased are excluded from SUA II coverage. Additionally, subscriber software installation and reprogramming are excluded from the ASTRO 25 SUA II coverage.
- 1.10 Motorola agrees to provide hardware version updates and/or replacements necessary to upgrade the system to an eligible system release with an equivalent level of functionality up to once in a two-year period. Hardware will be upgraded and/or replaced if required to maintain the existing feature & functionality of the eligible system release. The parties agree that any updates to hardware versions and/or replacement hardware required to support new features or those not specifically required to maintain existing functionality are not included.
- 1.11 Motorola agrees that the following hardware components are eligible for full product replacement when necessary per the eligible system release upgrade and if originally provided by Motorola:
 - 1.11.1 Servers
 - 1.11.2 PC Workstations
 - 1.11.3 Routers
 - 1.11.4 LAN Switches
- 1.12 Motorola agrees that the following hardware components are eligible for board-level replacement when necessary per the eligible system release upgrade. The parties agree that “board-level replacement” is defined as any Field Replaceable Unit (“FRU”) for the products listed:
 - 1.12.1 GTR 8000 Base Stations
 - 1.12.2 GCP 8000 Site Controllers
 - 1.12.3 GCM 8000 Comparators
 - 1.12.4 MCC 7500 Console Operator Positions
 - 1.12.5 STR 3000 Base Stations
 - 1.12.6 Quantar Base Stations
 - 1.12.7 Centracom Gold Elite Console Operator Interface Electronics
 - 1.12.8 Centracom Gold Elite Central Electronics Banks
 - 1.12.9 Ambassador Electronics Banks

- 1.12.10 Motorola Gold Elite Gateways
 - 1.12.11 ASTROTAC Comparators
 - 1.12.12 PSC 9600 Site Controllers
 - 1.12.13 PBX Switches for Telephone Interconnect
 - 1.12.14 NFM/NFM XC/MOSCAD RTU
- 1.13 The ASTRO 25 SUA II does not cover all products. Refer to section 2.0 for exclusions and limitations.
- 1.14 Motorola agrees to provide implementation services necessary to upgrade the system to an eligible system release with an equivalent level of functionality up to once in a two-year period. The parties agree that any implementation services that are not directly required to support the system upgrade are not included. The parties further agree that implementation services necessary for system expansions and/or new features or functionality that are implemented concurrent with the system upgrade are not included.
- 1.15 As major system releases become available, Motorola Agrees to provide the following software design and technical resources necessary to complete system release upgrades up to a maximum of one system release upgrade per two-year contract period.:
- 1.15.1 Review infrastructure system audit data as needed.
 - 1.15.2 Identify additional system equipment needed to implement a system release, if applicable.
 - 1.15.3 Complete a proposal defining the system release, equipment requirements, installation plan, and impact to system users.
 - 1.15.4 Advise Customer of probable impact to system users during the actual field upgrade implementation.
 - 1.15.5 Program management support required to perform the system upgrade.
 - 1.15.6 Field installation labor required to perform the system upgrade.
 - 1.15.7 Upgrade operations engineering labor required to perform the system upgrade.
- 1.16 The parties agree that the ASTRO 25 SUA II pricing is based on the system configuration outlined in Appendix B. The parties further agree that this configuration is to be reviewed annually on the contract renewal date. Any change in system configuration may require an ASTRO 25 SUA II price adjustment.
- 1.17 The parties agree and acknowledge that the ASTRO 25 SUA II applies only to system release upgrades within the ASTRO 25 7.x platform.
- 1.18 Motorola agrees to issue the Software Maintenance Agreement (“SMA”) bulletin on an annual basis and post it in soft copy on a designated extranet site for Customer access. Standard and optional features for a given ASTRO 25 system release are listed in the SMA bulletin.
- 1.19 The parties agree that all services described in this SOW are available during the Standard Business Day unless otherwise agreed to by Motorola.

1.20 Coverage Continuity.

- 1.20.1 The parties acknowledge and agree that the ASTRO 25 SUA II requires continuous coverage beginning within (90) days after the expiration of system warranty. Should the Customer delay purchase of an ASTRO 25 SUA II beyond (90) days from system warranty expiration or elect to discontinue the ASTRO 25 SUA II and later decide to reinstate coverage, additional payment(s) will be necessary to cover the period for which coverage was discontinued or delayed. The total of payments for lapses in coverage will not exceed 3 years in equivalent ASTRO 25 SUA II coverage.

1.21 The Customer agrees that they shall:

- 1.21.1 Contact Motorola upon receiving the SMA bulletin to engage the appropriate Motorola resources for a system release upgrade.
- 1.21.2 Purchase any additional software and hardware necessary to implement optional system release features or system expansions.
- 1.21.3 Provide or purchase labor to implement optional system release features or system expansions.
- 1.21.4 Provide high-speed internet connectivity at the zone core site(s) for use by Motorola to perform remote upgrades and diagnostics during the upgrade period.
- 1.21.5 Properly store and make available hardware and software required to perform software upgrade services needed for installation of the system release.
- 1.21.6 If the Servicer is required to travel beyond two (2) hours or one hundred twenty (120) miles by vehicle from the prime site to a remote site to deliver this service, the Customer is responsible for incremental travel and expenses incurred.
- 1.21.7 Inform system users of software upgrade plans and scheduled system downtime. Perform appropriate system backups and make them readily available during the installation of the system release.
- 1.21.8 Assist Motorola in the preparation of a Customer Support Plan before system acceptance and provide all information necessary to complete the Customer Support Plan.
- 1.21.9 Cooperate with Motorola and perform all acts that are reasonable or necessary to enable Motorola to provide software upgrade services.

2.0 Exclusions and Limitations

- 2.1 The parties agree that Systems that have non-standard configurations that have not been certified by Motorola Systems Integration Testing are specifically excluded from the ASTRO 25 SUA II unless otherwise agreed in writing by Motorola and included in this SOW.
- 2.2 The parties agree that the ASTRO 25 SUA II does not include hardware replacement for all products. Version updates may be available in some cases, but complete product replacement is not covered for all products.

- 2.3 The parties acknowledge and agree that the ASTRO 25 SUA II does not cover the following products:
- NICE Full Inform
 - MCC5500 Dispatch Consoles
 - MIP5000 Dispatch Consoles
 - Plant/E911 Systems
 - MOTOBRIDGE Solutions
 - ARC 4000 Systems
 - Motorola Public Sector Applications Software (“PSA”)
 - Custom SW, CAD, Records Management Software
 - Data Radio Devices
 - Mobile computing devices such as Laptops
 - Non-Motorola two-way radio subscriber products
 - Genesis Products
 - Point-to-point products such as Microwave terminals and association multiplex equipment
- 2.4 The parties further agree that the ASTRO 25 SUA II does not cover any hardware or software supplied to the system owner by any Motorola business sector other than Motorola Solutions and/or purchased directly from a third party, unless specifically included in this SOW.
- 2.5 The parties agree that the ASTRO 25 system release upgrades include limited security updates issued by Microsoft, Solaris and Red Hat certified with each individual system release.
- 2.6 The parties agree that the ASTRO 25 SUA II does not cover software support for virus attacks or other applications that are not part of the ASTRO 25 system, or unauthorized modifications or other misuse of the covered software. Motorola is not responsible for management of anti-virus or other security applications (such as Norton). Anti-virus and/or security application support may be covered under a separate agreement.
- 2.7 The parties agree that upgrades for equipment add-ons or expansions during the term of the contract are not included in the coverage of this SOW unless otherwise agreed to by Motorola.

3.0 Special provisions

- 3.1 Customer acknowledges that if its System has a Special Product Feature, additional engineering may be required to prevent an installed system release from overwriting the Special Product Feature. Upon request, Motorola will determine whether a Special Product Feature can be incorporated into a system release and whether additional engineering effort is required. If additional engineering is required Motorola will issue a change order for the change in scope and associated increase in the price for the ASTRO 25 SUA II.
- 3.2 Customer acknowledges that they may use the software (including any System Releases) only in accordance with the applicable Software License Agreement. The SUA II Statement of Work is not intended to modify or terminate an existing Software License Agreement. The SUA II or services rendered by Motorola does not alter Motorola’s software intellectual property rights.
- 3.3 Customer acknowledges that SUA II services do not include repair or replacement of hardware or software necessary due to defects that are not corrected by the system release, nor does it include

repair or replacement of defects resulting from any nonstandard or improper use or conditions or from unauthorized installation of software.

- 3.4 The parties agree that ASTRO 25 SUA II coverage and the parties' responsibilities described in this Statement of Work will automatically terminate if Motorola no longer supports the ASTRO 25 7.x software version in the Customer's system or discontinues the SUA II program; in either case, Motorola will refund to Customer any prepaid fees for System Upgrade Agreement services applicable to the terminated period.
- 3.5 Motorola may suspend or terminate the ASTRO 25 SUA II if the following conditions apply:
- Customer fails to pay Motorola any fees for the ASTRO 25 SUA II when due
 - Customer breaches the Software License Agreement or other applicable agreement
 - Customer's rights to use the software under the Software License Agreement expire or are terminated
 - Customer replaces its Motorola System with a system from another manufacturer

4.0 WARRANTIES AND DISCLAIMER:

Motorola warrants that its services will be free of defects in materials and workmanship for a period of ninety (90) days following completion of the service (“Warranty Period”). Your sole remedies are to require Motorola to re-perform the affected service or at Motorola's option to refund, on a pro-rata basis, the service fees paid for the affected service. Product and software documentation that specifies technical and performance features and capabilities, and the user, operation and training manuals for the Software (including all physical or electronic media upon which this information is provided) are collectively referred to as “Documentation.” During the applicable Warranty Period, Motorola warrants that the tested anti-virus definitions, intrusion detection sensor signatures, and operating system security updates/patches do not degrade or compromise System functionality, and that after incorporation of the recommended remediation action the System Software, when used properly and in accordance with the Documentation, will be free from a reproducible defect that eliminates the functionality or successful operation of a feature critical to the primary functionality or successful operation of the software. Whether a defect occurs will be determined solely with reference to the Documentation. Motorola does not warrant that Customer’s use of the software or products will be uninterrupted or error-free or that the software or the products will meet Customer’s particular requirements.

MOTOROLA DISCLAIMS ALL OTHER WARRANTIES WITH RESPECT TO PRETESTED ANTI-VIRUS DEFINITIONS, DATABASE SECURITY UPDATES, OPERATING SYSTEM SOFTWARE PATCHES, AND INTRUSION DETECTION SENSOR SIGNATURE FILES, EXPRESS OR IMPLIED, INCLUDING THE IMPLIED WARRANTIES OF MERCHANTABILITY, FITNESS FOR A PARTICULAR PURPOSE, AND NON-INFRINGEMENT. FURTHER, MOTOROLA DISCLAIMS ANY WARRANTY CONCERNING THE NON-MOTOROLA SOFTWARE AND DOES NOT GUARANTEE THAT CUSTOMER’S SYSTEM WILL BE ERROR-FREE OR IMMUNE TO VIRUSES OR WORMS AS A RESULT OF THESE SERVICES.

Appendix A – ASTRO 25 Eligible System Release Upgrade Paths

Release Date	Platform Release	Available Upgrade Paths	
Oct-05	R7.0	N/A	
Jun-06	R7.1	N/A	
Dec-06	R7.2	7.7	
Mar-07	R7.1.1	N/A	
Dec-07	R7.4	7.7	
Jun-08	R7.5	7.7	
Dec-08	R7.6	7.7	
Jun-09	R7.7	7.9	7.11
Jan-10	R7.8	7.9	
Dec-10	R7.9	7.11	7.13
Aug-11	R7.11	7.13	7.14 (planned)
Mar-12	R7.12	N/A	
Nov-12	R7.13	7.14 (planned)	7.15 (planned)
Nov-13	R7.14 (planned)	7.15 (planned)	7.16 (planned)

The information contained herein is provided for information purposes only and is intended only to outline Motorola’s presently anticipated general technology direction. The information in the roadmap is not a commitment or an obligation to deliver any product, product feature or software functionality and Motorola reserves the right to make changes to the content and timing of any product, product feature or software release. Prices for any future product or software included herein will be separately negotiated when and if such product or software becomes available.

The most current eligible system release upgrade paths can be found in the most recent SMA bulletin.

Appendix B - System Pricing Configuration

This configuration is to be reviewed annually on the contract renewal date. Any change in system configuration may require an ASTRO 25 SUA II price adjustment.

Louisville Metro	2015	2016	2017	2018	2019	2020	2021	2022	2023	2024
Core										
Master Site Configuration	M3	M3	M3	M3	M3	M3	M3	M3	M3	M3
Zones in Operation (Including DSR and Dark Master Sites)	1	1	1	1	1	1	1	1	1	1
Zone Features: IV&D, OTAR, TDMA, Telephone Interconnect, CNI, HPD, ISSI CSMS, IA, POP25, Text Messaging, Outdoor Location, ...	4	4	4	4	4	4	4	4	4	4
RF System										
Voice RF Sites & RF Simulcast Sites	18	18	18	18	18	18	18	18	18	18
Repeaters/Stations (FDMA)	327	327	327	327	327	327	327	327	327	327
Repeaters/Stations (TDMA)	0	0	0	0	0	0	0	0	0	0
HPD RF Sites	0	0	0	0	0	0	0	0	0	0
HPD Stations	0	0	0	0	0	0	0	0	0	0
Dispatch Console System										
Dispatch Sites	2	2	2	2	2	2	2	2	2	2
Gold Elite Operator Positions	28	28	0	0	0	0	0	0	0	0
MCC 7500 Operator Positions (GPIOM)	0	0	0	0	0	0	0	0	0	0
MCC 7500 Operator Positions (VPM)	44	44	72	72	72	72	72	72	72	72
Conventional Channel Gateways (CCGW)	21	21	21	21	21	21	21	21	21	21
Conventional Site Controllers (GCP 8000 Controller)	3	3	3	3	3	3	3	3	3	3
Logging System										
Number of AIS Servers	2	2	2	2	2	2	2	2	2	2
Number of Voice Logging Recorder	2	2	2	2	2	2	2	2	2	2
Number of Logging Replay Clients	0	0	0	0	0	0	0	0	0	0
Network Management and MOSCAD NFM										
Network Management Clients	2	2	2	2	2	2	2	2	2	2
MOSCAD NFM Systems	1	1	1	1	1	1	1	1	1	1
MOSCAD NFM RTUs	25	25	25	25	25	25	25	25	25	25
MOSCAD NFM Clients	2	2	2	2	2	2	2	2	2	2
Fire Station Alerting (FSA)										
FSA Systems	0	0	0	0	0	0	0	0	0	0
FSA RTUs	0	0	0	0	0	0	0	0	0	0
FSA Clients	0	0	0	0	0	0	0	0	0	0
Subscribers										
Voice Subscribers non-APX	9000	9000	9000	9000	9000	9000	9000	9000	9000	9000
Voice Subscribers APX	0	0	0	0	0	0	0	0	0	0
HPD Subscribers	0	0	0	0	0	0	0	0	0	0
Computing and Networking Hardware (for SUA / SUA II, actual replacement qty may be less than shown)										
Workstations - High Performance	4	4	4	4	4	4	4	4	4	4
Workstations - Mid Performance	75	75	75	75	75	75	75	75	75	75
Servers - High Performance	5	5	5	5	5	5	5	5	5	5
Servers - Mid Performance	5	5	5	5	5	5	5	5	5	5
LAN Switch - High Performance	3	3	3	3	3	3	3	3	3	3
LAN Switch - Mid Performance	30	30	30	30	30	30	30	30	30	30
Routers	49	49	49	49	49	49	49	49	49	49
Training										
# of onsite, instructor-led, 3-day training sessions	0	0	0	0	0	0	0	0	0	0

Statement of Work

NICE Gold Maintenance without remote access

Overview

Motorola utilizes NICE equipment to provide a complete, reliable and robust solution for Customer audio recording requirements.

1.0 Description of Services

Motorola System Support Center (SSC) will initiate the Customer service request to NICE Systems, Inc. (NICE). NICE will deliver services identified in the NICE Gold Maintenance tables provided in this SOW. Post warranty services provided by NICE include phone coverage, on site support and hardware support for applicable NICE IP Logging Equipment integrated within a Motorola network or MCC 7500 console site.

The terms and conditions of this Statement of Work (SOW) are an integral part of Motorola's Service Terms and Conditions or other applicable Agreement to which it is attached and made a part thereof by this reference.

2.0 Motorola has the following responsibilities:

- 2.1 Respond to request for post warranty support for the Restoration of a failed System.
- 2.2 Collect model, serial number information, customer name and customer contact.
- 2.3 Provide a case number.
- 2.4 Contact NICE support and provide them with customer, case number, model, and serial number information. NICE will contact the customer/field team and work the issue to completion.
- 2.5 Advise caller of procedure for determining any additional requirements.
- 2.6 Coordinate resolutions with agreed upon third party vendor.
- 2.7 Close the case once the NICE issue has been resolved.

3.0 Customer has the following responsibilities:

- 3.1 Contact Motorola System Support Center (SSC) to initiate a service request.
- 3.2 Provide model and serial number.
- 3.3 Provide a contact name and contact phone number.

4.0 NICE has the following responsibilities:

- 4.1 Provide repair return authorization numbers to Customer.
- 4.2 Provide services in accordance with Table 1, per the time zone where the equipment resides, Monday through Friday, excluding holidays, and within the normal response times.
- 4.3 Receive malfunctioning hardware from Customer and document its arrival, repair and return.
- 4.4 Perform the following service on NICE hardware:
 - 4.4.1. Replace malfunctioning components. NICE will use commercially reasonable efforts to repair or replace, in its discretion, any hardware found to be defective under normal and proper use and service during the contract period. An in-coverage unit will be repaired and returned at no charge except for under the following conditions:
 - (1) The unit has been modified or damaged due to improper packaging; or
 - (2) If a unit is received for repair and found operable in accordance with current NICE standards, it will be classified as "no trouble found" and it will be returned in the same condition in which it was received.

- 4.5 Coordinate any repair activity with Motorola and Customer to ensure resolution
- 4.6 On site reporting the NICE service provider (SP) will:
 - 4.6.1. Arrive at the Customer site and go directly to the Customer contact
 - 4.6.2. When SP is ready to leave, notify the Customer contact
 - 4.6.3. Provide verbal reports to the Customer contact on all work complete and in progress by NICE
 - 4.6.4. Sign out and leave with the Customer contact a visit report of the work accomplished by NICE and the outstanding issues
- 4.7 Provide to the Customer contact within one (1) week of the on site visit a follow-up report on any outstanding issues
- 4.8 Contact Motorola System Support Center to close the case
- 4.9 Perform services according to NICE service priorities

Table 1

This option is available to customers where the location of the equipment is within 4-hour drive time to most major metropolitan areas (identified at the time of purchase.

Support Coverage	Twenty-four (24) hours, seven (7) days per week
Call Back Response Time	Sixty (60) minutes after receipt of call from authorized representative
On-Site Response Time for Priority 1 Service Issues	Four (4) hours

Gold Available within a 4 Hour Drive Time	Priority 1	Priority 2	Priority 3	Priority 4
Phone Availability	24*7	24*7	24*7	24*7
Support Coverage	24*7	24*7	24*7	24*7
Call Back Response Time	60 minutes	120 minutes	24 hours	24 hours
On Site Response Times*	4 hours	24 hours	48 hours	48 hours

**On Site Response Time are in effect following the determination that on site support is required. Repair parts are shipped overnight, unless otherwise pre-arranged. The arrival of the technician and the shipped parts will be coordinated to coincide.*

Priority 1 – Critical Failure – In a 100% recording environment, any failure of equipment, NICE software or communications to the NICE products which results in loss of recording channels or data, or if allowed to persist will result in such recording loss.

Priority 2 – Major Problem – Any problem resulting in loss of ability to retrieve calls or loss of replay functionality for two or more workstations.

Priority 3 – Product Anomaly – Any problem affecting one or more workstations which does not result in a loss of recording or replay but nevertheless results in diminished Product response or performance, for example if an administrator loses the ability to add or delete users.

Priority 4 – System Inquiry, planned intervention or request for information.

4.10 Software Upgrades- NICE’s standard maintenance services shall include installation of only such software updates to the NICE software which, in NICE’s sole discretion, are necessary to ensure efficient operation of the products (“NICE Software Updates”). NICE will provide Customer with a version of the NICE Software Update for Customer to review and authorize for installation. Upon such installation, Customer shall receive a copy of all written materials necessary to allow Customer to operate such NICE Software Updates. All NICE Software Updates are licensed for use solely on the Equipment on which the relevant NICE Software was first installed.

5.0 Ineligible Products-Additional Service fees shall apply for any maintenance provided by NICE for any and all individual products that are damaged by causes not caused directly by the gross negligence or intentional misconduct of NICE and external to the relevant individual product, including without limitation, damages to a individual product caused by: (i) neglect, mishandling, misuse and/or unauthorized repair by anyone other than NICE or a NICE certified technician; (ii) failure to maintain the Site in accordance with NICE’s installation site specifications (“Installation Site Specifications”); (iii) relocation from the Site specified by the parties; (iv) use by anyone other than NICE or a NICE certified technician for purposes other than those for which it was designed, as described in the applicable documents, Operating Manuals and/or specifications provided by NICE; (v) use by anyone other than NICE or a NICE certified technician or material or supplies, including without limitation software and firmware programming, that do not meet NICE’s specifications and instructions; (vi) use of the Products with any Non-Nice Hardware and/or (vii) an accident, transportation, improper cooling or humidity control, failure to telephone equipment or communication lines, failure or fluctuation of electrical power, other unusual physical or electrical stress and/or failure of interconnect equipment not provided by NICE or a NICE certified technician.

6.0 In addition to any exclusions set forth in Section 7.0 below or in any other underlying Agreement to which this SOW is attached, the following items are excluded:

1. All Infrastructure older than seven (7) years from product cancellation date
2. Physically damaged Infrastructure
3. Third party Equipment not shipped by Motorola
4. Consumable items including, but not limited to, batteries, connectors, cables, tone/ink cartridges
5. Test Equipment
6. Racks, furniture and cabinets
7. Firmware and/or Software upgrades

7.0

Data System Infrastructure	Inclusions, Exclusions, Exceptions and Notes for Infrastructure Repair
Logging Recorder	Includes NICE IP logging recorders Excludes all other technologies
Rack Mounts/Shelves	Includes NICE rack mount/shelf ONLY Excludes all other technologies
Replay Station	Excluded
Servers/Storage Center	Includes NICE servers/storage centers ONLY Excludes all other technologies
Workstation	Excluded