



# GEOTECHNICAL EVALUATION REPORT

HURSTBOURNE APARTMENTS DEVELOPMENT  
LOUISVILLE, KENTUCKY

SME Project Number: 088601.00  
April 25, 2022





1200 Bell Lane, Suite B  
New Albany, IN 47150-7275

T (812) 590-4600

[www.sme-usa.com](http://www.sme-usa.com)

April 25, 2022

Kennedy International, Inc.  
c/o ARCO Senior Living Multi-Family  
900 North Rock Hill Road  
St. Louis, Missouri 63119

Attn: Mr. John Auble – Project Manager

Via E-mail: [jauble@arco1.com](mailto:jauble@arco1.com) (PDF file)

RE: Geotechnical Evaluation  
Hurstbourne Apartments Development  
4700 S Hurstbourne Parkway  
Louisville, Kentucky  
SME Project No. 088601.00

Dear Mr. Auble:

We have completed our geotechnical evaluation for the subject project. This report presents the results of our observations and analyses, our geotechnical engineering recommendations, and general construction considerations based on the information disclosed by the borings.

We appreciate the opportunity to be of service. If you have questions or require additional information, please contact me.

Sincerely,

**SME**

Wesley J. Hemp, PE, PG (LA), LEED AP  
Project Manager

# TABLE OF CONTENTS

- 1. INTRODUCTION ..... 1**
  - 1.1 SITE CONDITIONS ..... 1
  - 1.2 PROJECT DESCRIPTION..... 2
- 2. EVALUATION PROCEDURES..... 2**
  - 2.1 FIELD EXPLORATION ..... 2
  - 2.2 LABORATORY TESTING ..... 3
- 3. SUBSURFACE CONDITIONS ..... 3**
  - 3.1 SOIL CONDITIONS ..... 3
  - 3.2 GROUNDWATER CONDITIONS..... 5
- 4. ANALYSIS AND RECOMMENDATIONS ..... 5**
  - 4.1 FURTHER EVALUATION ..... 5
  - 4.2 SITE PREPARATION AND EARTHWORK ..... 6
    - 4.2.1 SITE DEVELOPMENT CONSIDERATIONS..... 6
      - 4.2.1.1 SHRINK/ SWELL SOILS ..... 6
      - 4.2.1.2 KARST CONSIDERATIONS ..... 7
      - 4.2.1.3 PRELIMINARY GLOBAL SETTLEMENT CONSIDERATIONS..... 7
    - 4.2.2 SITE SUBGRADE PREPARATION ..... 8
    - 4.2.3 SUBGRADE PREPARATION FOR SLABS..... 9
    - 4.2.4 PAVEMENT SUBGRADE RECOMMENDATIONS ..... 10
      - 4.2.4.1 PAVEMENT SUBGRADE PREPARATION ..... 10
      - 4.2.4.2 PAVEMENT DRAINAGE CONSIDERATIONS ..... 10
    - 4.2.5 ENGINEERED FILL REQUIREMENTS ..... 11
    - 4.2.6 CHEMICAL STABILIZATION CONSIDERATIONS ..... 12
  - 4.3 PRELIMINARY FOUNDATION RECOMMENDATIONS ..... 13
    - 4.3.1 SUBGRADE VERIFICATION..... 13
    - 4.3.2 SHALLOW FOUNDATIONS ..... 13
      - 4.3.2.1 OPTION 1A (PREFERRED) – SPREAD FOOTINGS ON ROCK..... 13
      - 4.3.2.2 OPTION 1B (PREFERRED) – MICROPILES..... 14
      - 4.3.2.3 OPTION 2 – BRAB TYPE III POST-TENSIONED SLAB/FOUNDATION ..... 14
      - 4.3.2.4 OPTION 3 – SPREAD FOOTINGS ON NATURAL SOILS OR FILL ..... 15
  - 4.4 SEISMIC SITE CLASSIFICATION ..... 16
  - 4.5 BELOW-GRADE WALLS AND DRAINAGE ..... 17
    - 4.5.1 WALL BACKFILL..... 17
    - 4.5.2 LATERAL EARTH PRESSURES AND SLIDING RESISTANCE ..... 17
    - 4.5.3 DRAINAGE ..... 17
  - 4.6 STORM-WATER MANAGEMENT BASIN ..... 18
  - 4.7 CONSTRUCTION CONSIDERATIONS ..... 18
    - 4.7.1 KARST CONSIDERATIONS..... 18
      - 4.7.1.1 PLANNING CONSIDERATIONS ..... 18
      - 4.7.1.2 SINKHOLE MITIGATION ..... 19
      - 4.7.1.3 MONITORING CONSIDERATIONS..... 19
    - 4.7.2 GENERAL CONSTRUCTION CONSIDERATIONS..... 20

**5. SIGNATURES ..... 21**

**APPENDIX A**

**BORING LOCATION DIAGRAM (FIGURE NO. 1)**

**IDENTIFIED KARST FEATURE OVERLAY MAP (FIGURE NO. 2)**

**BORING LOG TERMINOLOGY**

**BORING LOGS (B1 THROUGH B31)**

**APPENDIX B**

**IMPORTANT INFORMATION ABOUT THIS GEOTECHNICAL ENGINEERING REPORT**

**GENERAL COMMENTS**

**LABORATORY TESTING PROCEDURES**



# 1. INTRODUCTION

This report presents the results of our geotechnical evaluation for the proposed Hurstbourne Apartments Development project in Louisville, Kentucky. We conducted this evaluation in general accordance with the scope of services outlined in Task 3 of SME Proposal P00289.22 dated January 31, 2022. Please refer to the referenced proposal for information regarding our specific scope of services. Performance of this study was authorized by Mendy Reich with Kennedy International, Inc. on February 3, 2022. Optional Tasks 3a through 3c were not authorized for this evaluation.

To assist with our evaluation and the preparation of this report, SME was provided with a pre-application/detailed district development plan titled “4700 S Hurstbourne Parkway” prepared by Mindel Scott dated of November 29, 2021.

## 1.1 SITE CONDITIONS

The project site is located at the physical address 4700 S. Hurstbourne Parkway in Louisville, Kentucky. The location of the site is depicted on the Location Map inset on the Boring Location Diagram (Figure No. 1) included in Appendix A of this report and on Image 1 (*Site Location Map*) below.

This project site is approximately 19.5 acres and includes five (5) existing structures consisting of single-family residential and associated garages/barn structures. The project area is generally grass covered. Based on the topographic information on the provided referenced development plan, existing topography within the project area is described as rolling. In general, the project slopes downward to the north with ground surface elevations ranging from approximately 582 to 628 feet.



**IMAGE 1: SITE LOCATION MAP**

Visible active sinkhole features were observed at areas of subsidence with open throats and several depressed areas of possible subsidence during performance of our Karst Reconnaissance Survey. Refer to our Karst Reconnaissance Survey report (SME Project No. 088601.00) dated March 7, 2022 for additional details regarding apparent karst features observed at the project site.

The pond (or perennial stream as identified on LOGIC) located within the northwest portion of the site was mostly dry at the time of our initial evaluation, although the ground surface appeared to be soft. Water seepage was observed on the west side of the pond where the feature drained into a stream (and for which an old, displaced drainage outlet structure was observed). This area most likely a wetlands or ephemeral pond, which periodically holds some water for a period of time during or following precipitation

events prior to draining into the stream which subsequently ties into Fern Creek. The pond area is relatively shallow, which suggests the area may have been infilled either by natural causes (e.g., erosion or siltation) or man-placed fill, perhaps at the time of the observed drainage structure construction.

## 1.2 PROJECT DESCRIPTION

The project includes construction of a new apartment complex to be located at 4700 South Hurstbourne Parkway in Louisville, Kentucky. The proposed complex will include thirteen (13) multi-family housing buildings, a clubhouse building with an adjacent outdoor pool, associated parking areas and drives, and a stormwater management basin. We assume the multi-family housing buildings will have up to three stories. At this time, we do not have information regarding if the lower level will be slab-on-grade or partially recessed. The clubhouse will be a single-story, slab-on-grade structure. We understand shallow spread footings and concrete floor slab on grade construction have been proposed.

At the time this report was prepared, no specific structural loading information was provided to SME. Based on our experience with similar type structures, we anticipate structural loads could be in the range of 3 to 4 kips per linear foot for walls with isolated column loads not exceeding 50 kips.

A grading plan was not provided to us at this time. As mentioned in Section 1.1, existing site grades range from 582 to 628 feet across the site which could require significant earthwork activities to establish final site grades. However, based on the project development consisting of multiple isolated buildings, we assume the final site grades will vary across the site to accommodate existing grade changes and earthwork activities will be limited to cuts and fills of less than 10 feet to achieve final subgrade levels in the proposed building and pavement areas.

The recommendations of this report are based on the information provided above and the results of the field evaluation. Contact SME if the final design information is different than discussed herein.

## 2. EVALUATION PROCEDURES

### 2.1 FIELD EXPLORATION

SME performed thirty-two (32) borings (B1 through B31, plus B12A) at the project site between March 14 to March 17, 2022. The approximate as-drilled locations of the borings are depicted on Figure No. 1. ARCO Senior Living Multi-Family requested the number of borings. SME determined the planned depths and locations of the borings based on the project information provided to us. SME staked the borings in the field using a hand-held GPS unit with sub-meter accuracy.

Borings were advanced with a rotary drill rig using continuous-flight augers to the termination of the borings to facilitate the collection of soil samples. The borings included soil sampling based upon the Split-Barrel Sampling procedure. Soil samples recovered from the field exploration were delivered to our laboratory for further observation and testing.

Groundwater level observations were recorded during and after completion of drilling and sampling. After recording groundwater level observations, the boreholes were generally backfilled with auger cuttings. Therefore, long-term groundwater levels are not available from the borings.

**During backfilling of borings B12 and B12A (which was drilled due to auger deflecting away from plumb in B12 prior to reaching refusal), we were unable to effectively backfill the boreholes with the auger cuttings generated from drilling activities. An additional 15 bags (0.5 cubic foot each) of pea gravel were placed in the holes without backfilling the borings. A portable camera was lowered into the boreholes which allowed for us to observe a void space where backfill material was raveling laterally into. Traffic cones were placed at the surface at this location, and John Auble with ARCO Senior Living Multi-Family was notified by email and attempted phone call on March 18, 2022 to discuss filling the void space and advise those using the property avoid this area.**

## 2.2 LABORATORY TESTING

The laboratory testing program consisted of visual soil classification (in general accordance with ASTM D-2488) of the recovered samples and moisture content and hand penetrometer testing of portions of the cohesive samples obtained. Atterberg Limits (ASTM D 4318) testing was performed on select samples to characterize plasticity. The Laboratory Testing Procedures in Appendix B provide descriptions of the laboratory tests performed. Based on the laboratory testing, we prepared a soil description and assigned a group symbol to the various soil strata encountered based on the Unified Soil Classification System (USCS).

Upon completion of the laboratory testing, boring logs were prepared which include information on materials encountered, the soil descriptions, penetration resistances, pertinent field observations made during the operations, and the results of the laboratory testing. The boring logs are included in Appendix A. Explanations of symbols and terms used on the boring logs are provided on the attached Boring Log Terminology sheet.

Soil samples are normally retained in our laboratory for 60 days and then disposed, unless instructed otherwise.

## 3. SUBSURFACE CONDITIONS

### 3.1 SOIL CONDITIONS

The borings were typically performed in areas covered with surficial topsoil. The surficial topsoil thickness at these locations was approximately 5 to 10 inches. These thickness measurements reported on the boring logs should be considered approximate since mixing of these materials can occur in small diameter boreholes. Therefore, if more accurate thickness measurements are required, we recommend performing additional evaluations such as shallow test pits or hand augers.

Below the surficial layer, the subsurface conditions encountered at the borings generally consisted of soft to very stiff lean clays (CL) and fat clays (CH) extending to the encountered depths of auger refusal. An Atterberg limits test performed on a sample of the lean clay obtained from B3 from approximately 1 to 2.5 feet below the existing ground surface resulted in a liquid limit (LL) of 35%, plastic limit (PL) of 20%, and plastic index (PI) of 15%. Atterberg limits tests performed on samples of the fat clay obtained from B16 from approximately 6 to 7.5 feet and B23 from approximately 1 to 2.5 feet below the existing ground surface resulted in liquid limits (LL) of 53 to 55%, plastic limits (PL) of 19 to 22%, and plastic indices (PI) of 33 to 34%. Table 1 summarize the soft clays encountered at the boring locations. Medium dense sand (SP) was encountered below the clays at borings B24 and B25 at a depth of about 3.5 feet and extended to the depth of auger refusal.

**TABLE 1: SUMMARY OF SOFT CLAYS**

| BORING NUMBER | SOIL TYPE                   | APPROXIMATE DEPTH (FEET) <sup>(1)</sup> |
|---------------|-----------------------------|-----------------------------------------|
| B1            | Very Soft to Soft Lean Clay | 0 – 3.5                                 |
| B2            | Very Soft Lean Clay         | 0 – 3.5                                 |
| B3            | Very Soft to Soft Lean Clay | 0 – 3.5                                 |
| B4            | Very Soft Lean Clay         | 0 – 3.5                                 |
| B7            | Very Soft to Soft Lean Clay | 0 – 1.5                                 |
|               | Very Soft to Soft Fat Clay  | 1.5 – 3.5                               |
| B8            | Very Soft to Soft Lean Clay | 0 – 3.5                                 |
| B9            | Soft Lean Clay              | 0 – 1.5                                 |

| BORING NUMBER | SOIL TYPE                       | APPROXIMATE DEPTH (FEET) <sup>(1)</sup> |
|---------------|---------------------------------|-----------------------------------------|
|               | Soft Fat Clay                   | 1.5 – 3.5                               |
| B10           | Soft to Medium Lean Clay        | 0 – 1.3                                 |
|               | Soft to Medium Fat Clay         | 1.3 – 1.8                               |
| B11           | Soft to Medium Lean Clay        | 0 – 1.4                                 |
| B12           | Very Soft to Soft Lean Clay     | 0 – 13.5                                |
| B14           | Soft to Stiff Lean Clay         | 0 – 3.5                                 |
| B17           | Very Soft Lean Clay             | 0 – 3.5                                 |
| B19           | Soft to Medium Lean Clay        | 0 – 3.1                                 |
| B20           | Very Soft to Soft Lean Clay     | 0 – 3.5                                 |
| B21           | Soft to Medium Lean Clay        | 0 – 3.5                                 |
|               | Soft to Very Stiff Lean Clay    | 6 – 7.6                                 |
| B22           | Soft Lean Clay                  | 0 – 3.5                                 |
| B28           | Soft to Medium Lean to Fat Clay | 0 – 3.5                                 |
| B30           | Soft Lean to Fat Clay           | 0 – 2.9                                 |
| B31           | Soft Fat Clay                   | 0 – 3.5                                 |

Notes

1. Refers to depth below existing ground surface.

Auger or splitspoon refusal on assumed rock was encountered in borings performed for this project. In general, the depth to refusal (apparent rock) appeared to vary from about 1.4 to 15.8 feet below the existing ground surface when encountered. The table below summarizes the depths of auger or splitspoon sampler refusal at the boring locations. Suspected rock (dolomite, limestone, and sandstone) was encountered several inches above the recorded refusal depths at select boring locations. It is assumed the sampler penetrated the rock disintegration zone (RDZ) just above the refusal depths. Refusal can sometimes be encountered on limestone “floaters” i.e., boulders within a matrix of soil, and not on sound bedrock. Rock coring was not performed to further evaluate the presence of sound rock, rock quality, or hardness.

**TABLE NO. 2: SUMMARY OF AUGER/SAMPLER REFUSAL DEPTHS**

| BORING NUMBER | APPROXIMATE REFUSAL DEPTH (FEET) <sup>(1)</sup> |
|---------------|-------------------------------------------------|
| B1            | 7.9                                             |
| B2            | 9.5                                             |
| B3            | 6.3                                             |
| B4            | 7.6                                             |
| B5            | 7.2                                             |
| B6            | 6.2                                             |
| B7            | 6.8                                             |
| B8            | 7.4                                             |
| B9            | 4.8                                             |
| B10           | 1.8                                             |
| B11           | 1.4                                             |
| B12A          | 15.8                                            |

| BORING NUMBER | APPROXIMATE REFUSAL DEPTH (FEET) <sup>(1)</sup> |
|---------------|-------------------------------------------------|
| B17           | 5.9                                             |
| B18           | 13.4                                            |
| B19           | 3.3                                             |
| B20           | 8.7                                             |
| B21           | 7.6                                             |
| B22           | 6.6                                             |
| B23           | 7.4                                             |
| B24           | 6.4                                             |
| B25           | 5.9                                             |
| B26           | 2.8                                             |
| B27           | 6.3                                             |
| B28           | 5.6                                             |

| BORING NUMBER | APPROXIMATE REFUSAL DEPTH (FEET) <sup>(1)</sup> |
|---------------|-------------------------------------------------|
| B13           | 4.6                                             |
| B14           | 6.8                                             |
| B15           | 6.7                                             |
| B16           | 10.3                                            |

| BORING NUMBER | APPROXIMATE REFUSAL DEPTH (FEET) <sup>(1)</sup> |
|---------------|-------------------------------------------------|
| B29           | 3.5                                             |
| B30           | 3                                               |
| B31           | 8                                               |

Notes

1. Refers to depth below existing ground surface.

The profile described in this report and included on the boring logs is a generalized description of the encountered conditions. The stratification depths described in this report and shown on the logs indicate a zone of transition from one soil or rock type to another. They are not meant to delineate exact depths of change between soil or rock types. Soil conditions may vary between or away from the exploration locations. Please refer to the boring logs for the soil descriptions, rock descriptions (when applicable), and results of the field and laboratory tests at the specific exploration locations.

### 3.2 GROUNDWATER CONDITIONS

Groundwater was not encountered during and/or upon completion of drilling operations. In clays, a long time may be required for the groundwater level in the borehole to reach an equilibrium position. Therefore, the use of groundwater observation wells (piezometers) is necessary to accurately determine the hydrostatic groundwater level within cohesive soils such as encountered at this site. Groundwater flow in karst terrain is erratic and unpredictable due to complexly interconnected voids, fissures, fracture zones within the rock.

Expect hydrostatic groundwater levels, perched groundwater, and the potential rate of infiltration into excavations to fluctuate throughout the year, based on variations in precipitation, evaporation, run-off, and other factors. The groundwater levels indicated by the borings represent conditions at the time the readings were observed. The actual groundwater levels at the time of construction may vary.

## 4. ANALYSIS AND RECOMMENDATIONS

### 4.1 FURTHER EVALUATION

Surficial evidence of sinkholes was observed during our field activities as discussed in our Karst Reconnaissance Survey report (SME Project No. 088601.00) dated March 7, 2022. In addition, a void was encountered within the soil profile during backfilling of the borehole at borings B12 and B12A. As noted in the Karst Reconnaissance Survey report, we recommend adjusting the site plan where possible to shift proposed structure locations away from identified sinkhole features. Where shifting of structures is not possible, remediation of sinkholes and alternative foundation systems will be required to support the proposed buildings. Further evaluation is recommended prior to construction to evaluate the impacts on the proposed development and provide additional specific remedial recommendation for sinkholes and karst features. This service may include a combination of targeted additional drilling, rock coring, excavation, and/or geophysical imaging services to characterize surficial sinkholes observed within the limits of proposed development. Sinkholes located in pavement areas will also require remediation as directed by SME.



## 4.2 SITE PREPARATION AND EARTHWORK

### 4.2.1 SITE DEVELOPMENT CONSIDERATIONS

Challenges related to the proposed development include:

- Fat clays with shrink/swell potential
- Risks associated with development on karst terrain
- Soft near-surface clays
- The potential need for significant grade changes within the footprints of individual structures, with assumed fills of up to 8 feet at some locations to achieve the anticipated subgrade levels. However, a grading plan has not been provided to us at this time to determine the planned cut/fill at the site.

#### 4.2.1.1 SHRINK/ SWELL SOILS

Fat clays (CH) having liquid limits (LL) of 53 to 55%, plastic limits (PL) of 19 to 22%, and plastic indices (PI) of 33 to 34% were recorded for the referenced representative test samples. Based on the limited number of Atterberg limits test samples, soils with higher plasticity properties may exist on the project site. Fat clays are expected to be present at and below design bottom of the foundation level. It will be important to properly identify these soils in the building pad during foundation construction and then remediate these areas to minimize further soils movements that could be detrimental to the structures (see below).

Highly plasticity soils are sensitive to volume changes (shrink/swell) with changes in moisture content, which can fluctuate throughout the seasons and cause movements below slabs, pavements, foundations, etc. supported by these soils. These movements can result in damage to the structure (e.g., brick/masonry, walls, and interior finish cracking), out of square doors and/or window openings, and premature loss of serviceability of slabs and pavements. This risk for distress can be reduced by properly preparing subgrade soils and minimizing changes in soil moisture content of the clay subgrade. Also, avoid excessive irrigation around the structure and do not allow roof downspouts to discharge water adjacent to the perimeter foundations. Protect exposed subgrades from desiccation via placement of sacrificial gravel base layer or leave subgrade elevation cut high until just prior to floor slab or pavement construction. Isolate utility stickups through slabs to accommodate potential movements.

We recommend the foundations or other structural elements (such as floor slabs, pavements, etc.) not bear directly on high plasticity clays soil due concerns regarding the susceptibility for these soils to experience volume change due to seasonal variation in soil moisture content. Where this type of soil is encountered, remove (undercut) the subgrade as necessary and replace with a minimum of 2 feet of a low to non-expansive engineered fill (i.e., KYTC DGA) below the structural elements compacted per the requirements in Section 4.1.5 of this report. Chemical subgrade modification (i.e., cement or lime treatment) may also be considered for expansive clay mitigation (refer to Section 4.2.6).

Ground improvement (e.g., removal and replacement) may not be necessary at the locations of moderately plastic lean clays (CL) soils where exposed (e.g., LL of less than 50), provided the following recommendations are adhered to. However, suitable subgrade conditions should be verified during construction. Where exposed in foundation, floor slab, or pavement areas, the subgrade should be evaluated for in-situ moisture content and plasticity. The in-situ moisture should be between the optimum moisture content and not more than + 2 percent of the optimum moisture content (while simultaneously meeting bearing capacity requirements) for the upper 18 inches of the soil profile. Protect the exposed subgrade soils from desiccation (as previously described) immediately after moisture conditioning soils (where required) and prior to reinforcing steel and concrete placement.

Planting of trees where shrink/swell soils are present is particularly problematic, as tree roots tend to grow in the direction of a water source and thereby reducing soil moisture content. This can lead to drying and shrinkage of the fat clay soils. Soil shrinkage adjacent to building foundations can manifest as settlement due to volume changes in the underlying soils. Therefore, we recommend trees not be planted directly adjacent to proposed structures.

#### **4.2.1.2 KARST CONSIDERATIONS**

SME performed a Karst Reconnaissance Survey (SME Project No. 088601.00) with our report dated March 7, 2022. Our review of the available geological literature and our visual reconnaissance at the project site suggests the underlying rock is prone to karst development (i.e., sinkholes and associated features). Refer to our Karst Reconnaissance Survey report for additional details and evaluation procedures.

In general, this site has elevated risk for karst development based upon the presence of existing sinkholes documented in our previously referenced report. A quantitative risk of potential for future sinkhole activity is difficult to provide without significant additional characterization (i.e., additional test borings, rock core borings, and geophysical surveys). However, the relative risk is likely no greater than that of adjacent developments constructed on terrain of similar geology. The risk of sinkhole development and karst activity cannot be eliminated but can be reduced by implementing measure and mitigation techniques outlined in this report.

Engineering works and site development can result in acceleration of incipient sinkhole development or encourage new sinkhole formation. These features may appear dormant in their existing state, but subsidence can be activated by changes in the natural drainage pattern due to construction works. Subsidence caused by karst features can result in excessive and uneven settlement of structures and structural distress requiring underpinning or replacement of foundations, replacement of grade slabs and pavements, or other structural remedies. Therefore, we recommend adjusting the site plan when possible to shift proposed structure locations away from identified sinkhole features and performing further investigation as mentioned in Section 4.1 to further evaluate karst features within the project area and provide specific sinkholes remediation recommendations.

SME's scope of services for this evaluation did not include evaluating the site for settlement potential caused by karst features, which would require rock coring and/or utilization of geophysical evaluation methods.

#### **4.2.1.3 PRELIMINARY GLOBAL SETTLEMENT CONSIDERATIONS**

Portions of the project area are expected to require fill to raise the site grades; however, a site grading plan has not been provided to SME for us to evaluate the quantity of cuts and fills required across the project site.

The weight of the new fill required to establish site grades will act as a load on the underlying clay soil. In the case of the soft to very stiff clays at this site, this load will result in longer-term consolidation settlement. Consolidation settlement occurs when a load (such as the weight of the new fill) compresses the underlying cohesive soil by squeezing the water out of the pore spaces. With clay soils, this type of settlement often continues over a time period of years after the new load is applied.

A site grading plan is critical for further evaluation of anticipated settlement to occur throughout the site. The quantity of consolidation settlement will be dependent on the height of grade raise fill and the underlying soil profile at the location of fill placement. Preliminarily, we do not anticipate significant consolidation settlement based upon the anticipated maximum fill depths and provided the recommendations in this report are followed. However, excessive settlement could occur if deeper fills are expected and/or the near-surface, soft clay soils are not remediated appropriately.

Additional evaluation (including laboratory consolidation testing) is necessary to evaluate the amount of expected settlement as well as timeframe to achieve consolidation. Implementation of settlement plates and/or stakes will be necessary for monitoring settlement over time, depending upon the amount of fill placed and expected settlement.

Most of the soft clay soils encountered in the borings were observed directly below the topsoil layer. Therefore, we estimate that global settlement concerns can be substantially reduced by removal of these soils during mass grading. These soils could then be re-used to reduce the need for imported fill and/or reduce undercutting/chemical modification of fat clay soils.

After undercutting the soft, lean to silty clay and stockpiling, undercut the fat clay soil encountered above finished grade and use as grade-raise fill in deeper fill areas. Place fat clays in controlled lifts to no higher than 2 feet below the bottom of structural elements (e.g., foundations, floor slabs, or pavements). Redistribute stockpiled lean clay over fat clay soils and moisture condition as necessary to meet compaction and moisture requirements.

#### **4.2.2 SITE SUBGRADE PREPARATION**

Remove existing foundations, utilities, and other below-grade structures from previous construction to expose suitable natural soils and replaced with properly prepared engineered fill below new foundation areas within the building footprint. Remove existing below-grade obstructions at least 2.5 feet below final subgrade level to avoid creating "hard spots" in the subgrade in slab-on-grade and pavement areas. Backfill these areas where obstructions are removed with engineered fill, which is placed in lifts and properly compacted. Unsuitable existing backfill should be undercut and replaced with granular engineered fill (e.g., KYTC DGA) or flowable fill. Exercise care when excavating near existing utilities to protect them from damage.

The proposed development areas, along with other areas to receive engineered fill, must be cleared of existing topsoil, root mats, and other deleterious materials to expose the underlying inorganic subgrade soils. We recommend the clearing and stripping extend a minimum of 5 feet beyond the building areas. Furthermore, any exposed highly plastic (CH) fat clays must be undercut and replaced or modified below foundations, floor slabs, and pavements as discussed in this report.

After stripping surficial materials and removing deleterious materials, after cuts are made to design subgrade levels, but prior to filling, we recommend the subgrade be subjected to a comprehensive proof-rolling program in the presence of SME. The purpose of proof-rolling is to locate areas of unsuitably soft/loose or disturbed subgrade. We recommend proof-rolling be performed with a fully-loaded, tandem-axle dump truck or other pneumatic-tire construction equipment. Areas of unsuitable subgrade (for placement of new fill) revealed during proof-rolling must be mechanically improved (compacted) in-place or removed and replaced with engineered fill.

The exposed subgrade soils are susceptible to disturbance due to weather and activity on-site. Therefore, avoid disturbance of the subgrade and to ensure these soils are suitably prepared prior to the placement of engineered fill. Areas of prepared subgrade may be protected from disturbance during construction by placing a layer of crushed aggregate or crushed concrete over the subgrade. The contractor needs to remove or drain ponded surface water and grade the site to prevent surface water from draining toward, or ponding over the building footprint and other areas of prepared subgrade.

If the subgrade becomes disturbed during the earthwork operations, it will be necessary to mechanically improve the disturbed subgrade by compacting the soil; removing and replacing the disturbed soils with engineered fill, crushed aggregate, or crushed concrete.

After the exposed subgrade is evaluated (as described above) and improved as necessary, engineered fill may be placed on the exposed subgrade to establish final design subgrade levels. See Section 4.2.5 of this report for materials and compaction requirements for engineered fill.



### 4.2.3 SUBGRADE PREPARATION FOR SLABS

We anticipate the floor slab subgrades for the proposed buildings will consist of natural lean clays, fat clays, and/or engineered fill overlying the same and will depend on the proposed finished floor elevations (FFE), which were not provided to us at this time. Additionally, in areas of planned cuts or where rock pinnacles are encountered during construction, areas of the subgrade may consist of rock. Fat clays encountered during construction must be undercut a minimum of 24 inches below the bottom of the slab (unless a post-tensioned slab foundation is utilized as discussed in Section 4.3.2.3). The exposed subgrade should be proofrolled, and the undercut area will require being backfilled with engineered fill that is properly placed and compacted as discussed in Section 4.2.5 prior to construction of floor slabs.

Additional undercutting and replacement of soft soils is required if encountered, depending upon the results of proofrolling (see paragraph below). Depending on weather conditions at the time of construction, chemical modification or stabilization of the subgrade could be considered to manage high moisture contents within the clays and reduce shrink/swell potential. Additionally, geogrid could be utilized to limit the amount of undercutting required to achieve a stable subgrade for floor slab support (but will not provide sufficient resistance to shrink/swell soils).

Moderately plastic (CL/CH) soils may remain in-place below slabs provided (a.) some risk of premature loss of serviceability is acceptable and (b.) the in-situ moisture content for the exposed soils (minimum depth of 1-foot) is maintained within optimum and + 2 percent of the optimum moisture content as determined by the Standard Proctor test (ASTM D 698). Delineation and remediation of near-surface highly plastic (CH) clay soil is necessary for proper slab performance. Due to presence of highly plastic clays near the existing ground surface, we recommend performance of PVR evaluation for floor slab areas (in addition to foundation areas) to evaluate the potential for subgrade heave.

Where encountered, undercut rock or exposed pinnacles a minimum of 24 inches below the subgrade level and backfilled with engineered fill to minimize hard spots or point loading on slabs. Depending on weather conditions at the time of construction, chemical modification or stabilization of the subgrade could be considered to manage high moisture contents within the clays. Mechanical reinforcement (i.e., geogrid) can be considered at transition zones where rock undercut transitions to soil bearing conditions. We recommend geogrid utilized for this purpose extend a minimum distance of 10 feet on either side of the rock transition zone to minimize potential for differential settlement at the transition zones.

We recommend the slab-on-grade subgrade soils be protected from frost action during winter construction. Frozen soils must be thawed and compacted, or removed and replaced prior to slab-on-grade construction. Prior to concrete placement for slabs, the subgrade needs to again be observed and tested to identify areas of subgrade that were disturbed during construction activities and to verify subgrade conditions are suitable for slab support. We recommend proof-rolling the final subgrade. If proof-rolling is not feasible because of access constraints, SME must observe and test the exposed subgrade using density in-place meters and/or other hand-operated equipment such as hand augers and cone penetrometers. Unsuitable subgrade indicated by SME needs to be removed and replaced with engineered fill or chemical modification could also be considered.

We recommend providing a minimum 6-inch thick slab subbase consisting of free-draining granular-type soils with less than 5 percent fines to provide a leveling surface for construction of the slab and a moisture capillary break between the slab and the underlying soils. KYTC No. 57 crushed stone would be suitable for this purpose and would provide improved stability in the event the work will be performed during seasonally wet times of the year. However, the thickness of dense-graded aggregate may need to be increased based on the floor loads for the slabs and to protect the subgrade during construction. When determining the aggregate thickness, consider the time of year, the condition of subgrade soils during construction, and the type and volume of construction equipment to traffic the prepared subgrade. The aggregate must also be compacted per Section 4.2.5 of this report.

We recommend a subgrade modulus ( $k_{30}$ ) of 100 pounds per square inch (psi) per inch of deflection be used to design slabs supported on properly prepared subgrade and subbase course as described above. The recommended subgrade modulus  $k_{30}$  is based on correlations with soil type developed from plate load tests conducted using a 30-inch diameter plate with 0.05-inches of deflection.

Floor slabs need to be separated by isolation joints from structural walls and columns bearing on their own foundations to permit relative movement. A minimum of 6-inches of engineered fill is recommended between the bottom of the slab and the top of the shallow spread foundation below.

We recommend a vapor retarder be provided below the floor slab if the slab is to receive an impermeable floor finish/seal or a floor covering which would act as a vapor barrier. The location of the vapor retarder (relative to the subbase) should be determined by the Architect/Engineer based on the intended floor usage, planned finishes, and in accordance with ACI recommendations.

## **4.2.4 PAVEMENT SUBGRADE RECOMMENDATIONS**

### **4.2.4.1 PAVEMENT SUBGRADE PREPARATION**

The pavement subgrades should be prepared consistent with and as described in Section 4.2.2 Site Subgrade Preparation. However, in conjunction with Section 4.2.2, we recommend the supplemental pavement subgrade recommendations provided below.

The borings encountered fat clay at some locations, as well as moderately plastic clays throughout the site. Where encountered, moderately to highly plastic material must be undercut a minimum of 24 inches below the asphalt/concrete pavement section. The exposed subgrade should be proofrolled, and the undercut area backfilled with low volume change potential engineered fill that is properly placed and compacted as discussed in Section 4.2.5 prior to construction of pavements. Moderately plastic clays that pass a proofroll may be left in-place provided the Owner is willing to accept some risk associated with premature loss of serviceability. This risk can be further reduced by moisture conditioning the upper 2 feet of the soil subgrade to within optimum and +2% of optimum moisture as described in Section 4.2.3.

Additional undercutting and replacement of soft soils should be performed when encountered. In areas fill is placed to raise the site grade, the upper 2 feet of fill in pavement subgrade areas must consist of non-expansive materials such as lean clay or KYTC DGA (dense-graded aggregate). Additionally, rock (including pinnacles) encountered will require a minimum of 24 inches below the subgrade level and backfilled with engineered fill to minimize hard spots are transition between pavements supported on rock/soil. Depending on weather conditions at the time of construction, chemical modification or stabilization of the subgrade could be considered to manage high moisture contents within the clays or as an alternative to undercutting highly plastic clays (refer to Section 4.2.6). Mechanical reinforcement (i.e., geogrid) can be considered at transition zones where rock undercut transitions to soil subgrade conditions. We recommend geogrid utilized for this purpose extend a minimum distance of 10 feet on either side of the rock transition zone to minimize potential for differential settlement at the transition zones. Contact SME for additional direction and recommendations if geogrid is utilized for this purpose.

The necessary amount of stabilization of subgrade soils should be determined by proofrolling. The subgrade should be thoroughly proofrolled in the presence of SME prior to placing fill or the proposed pavement section. Proofrolling should be performed with a fully-loaded, tandem-axle dump truck or other pneumatic-tire construction equipment. Areas of unsuitable subgrade (deflection or rutting ½ inch or greater) revealed during proofrolling should be mechanically improved (compacted) in-place or removed and replaced with engineered fill. Without proper subgrade preparation, proper compaction of overlying fill and pavement layers could be difficult, affecting long-term pavement performance.

### **4.2.4.2 PAVEMENT DRAINAGE CONSIDERATIONS**

The subgrade should be graded to provide proper drainage of water out of the pavement system. We recommend the subgrade be sloped similarly to the proposed pavement surface. The subgrade preparation, along with the aggregate base and subbase layers, should extend laterally at least 18 inches

beyond the edge of pavement surfaces or concrete curb face to provide support for the outer edges of the pavement. Once completed, we recommend the pavement layers be placed soon thereafter to avoid subgrade disturbance.

The pavement system must be properly drained to reduce the potential of frost heaving and softening of the subgrade due to water infiltrating through cracks. In general, we recommend constructing a pavement with a minimum of 1.5 percent surface slope to promote positive drainage. Additionally, we recommend sloping the surrounding ground surface away from pavements to improve surface drainage.

For subsurface drainage, we recommend installing underdrains. The installation of underdrains underlying pavement sections founded over low permeability soils (e.g., clays) will generally aid in improving long-term performance of the pavement sections, as well as helping reduce pavement maintenance costs. Therefore, we recommend that at each catch basin, a series of finger-drains be installed that consist of a minimum 25 feet long section of underdrain installed in four directions.

Curb inlets (if provided) should have 50 feet long sections of underdrains installed in a minimum of two directions to provide subsurface drainage. Furthermore, cut-off drains should be installed along the perimeter of the pavement where adjacent ground surface elevations slope towards the pavement. Other areas of strategically placed additional underdrains might also be beneficial at this site.

We recommend the drain trenches be excavated to a minimum depth of 18 inches below the bottom of the aggregate base be at least 12-inches wide. The trench should be wrapped in a non-woven geotextile fabric (e.g., Mirafi® 140N or 160N) and backfilled with KYTC No. 57 crushed limestone. The underdrains should consist of a minimum 6-inch corrugated perforated PVC pipe bedded on a minimum 3 inches of KYTC No. 57 crushed limestone and the fabric should be overlapped on top of the trench. The trench should be backfilled to the proposed bottom elevation of the aggregate base course and the fabric should be suitably overlapped on top of the trench in the prepared subgrade. If chemical modification of the subgrade soils is required during construction, underdrains within the pavement areas should be installed after the chemical modification has been completed. Though not in the scope of our original services, SME can provide layout recommendations for underdrain placement upon request.

#### 4.2.5 ENGINEERED FILL REQUIREMENTS

Fill placed within the construction area must be free of frozen soil, organics, construction debris, particle sizes that will hinder compaction, or other deleterious materials. Materials utilized as engineered grade-raise fill or structural backfill should have a liquid limit of no greater than 40 percent, a plastic limit of no greater than 20 percent, a plasticity index of no greater than 20, a maximum dry density of no less than 100 pounds per cubic foot (pcf), and an organic content of less than 4 percent. To meet these requirements, we recommend any imported or on-site borrow material consist of lean clay (CL) per the Unified Soils Classification System, KYTC DGA (dense-graded aggregate), or chemically modified soils. Utilization of alternative fill materials may be considered, but should be reviewed and accepted by the project geotechnical engineer. On-site highly plastic soils can be chemically modified to meet plasticity requirements. Additional laboratory testing including evaluation for sulfates, pH, plasticity, and compressive strength (at minimum) is required if chemical stabilization/modification is considered.

The need for or extent of moisture conditioning or chemical modification will be affected by seasonal weather conditions at the time the earthwork is performed, and the condition of the site soils. The project specifications should include provisions for moisture conditioning of soils to be placed and compacted on-site as engineered fill or chemical modification. Contractors should anticipate the need for moisture conditioning or chemical modification and structure their bids accordingly.

The fill supporting foundations, floor slabs, and pavement sections should be compacted to 100 percent of the maximum dry density determined in accordance with the standard Proctor test. The minimum compaction requirement for fill adjacent to foundations and over foundations should be compacted to 95 percent of the standard Proctor maximum dry density. Fill 1 foot or greater below the floor slab and pavement section can also be compacted to 95 percent of the standard Proctor.

The fill must be spread in level layers not exceeding 9 inches in loose thickness. For areas where smaller walk-behind or hand compactors are required or utilized, the loose lift thickness should be reduced to a maximum of 6 inches. Granular fill should be compacted with a smooth drum vibratory roller or vibratory plate compactors including either walk-behind types, or plate compactors mounted on a backhoe or excavator (hoe-pac). Compact granular fill at a moisture content ranging from the optimum moisture content to about 2 percent below optimum. Clay fill should be compacted using a sheepsfoot roller, or a pneumatic type compactor, generally at a moisture content ranging from 2 percent below to 2 percent above the optimum moisture content. Compaction requirements for clay must be modified as previously discussed for moderately to highly plastic (CL/CH) fill placed within 2 feet of the finished subgrade.

If necessary, coarse crushed aggregate used to backfill undercuts or to stabilize subgrades should consist of a well-graded crushed natural aggregate consistent of KYTC DGA or CSB. Mechanical stabilization (geogrid) can also be considered. In cases where granular engineered fill will be placed over the coarse crushed aggregate, the surface of the coarse crushed material must be covered with a suitable non-woven geotextile (e.g., Mirafi® 140N or 160N) to prevent migration of the granular materials into the coarser crushed aggregate.

#### 4.2.6 CHEMICAL STABILIZATION CONSIDERATIONS

Additional laboratory testing including evaluation for sulfates, pH, plasticity, and compressive strength (at minimum) is required if chemical stabilization/modification is considered. Furthermore, presence of chert and/or cobbles within the soil strata can inhibit the mixing of the soils and chemical agent, therefore making chemical treatment impractical. SME can assist the foundation contractor with determining if/where higher plasticity clays are present below structural elements or pavement subgrades, or providing recommendations for mitigation.

Due to the anticipated high moisture contents of the site clays and the highly plastic (fat) clays encountered, we recommend considering chemical stabilization or modification at this site. Performing chemical subgrade stabilization can reduce the amount of undercutting in pavement areas, while reducing the moisture sensitivity of the subgrade. Chemical stabilization improves the subgrade stability and provides a stable working platform.

This method mitigates the risk of canceled workdays due to wet weather conditions, and will reduce unanticipated costs and delays associated with moisture conditioning wet soils or removing and replacing disturbed soils, as the stabilized subgrade is less susceptible to disturbance and softening due to rain events, even when trafficked by construction equipment.

The chemical stabilization is intended to modify the clay soils to reduce the frost susceptibility of the subgrade and mitigate premature pavement distress due to frost action. Chemical stabilization can also reduce the effective plasticity index of high or moderate plasticity soils (and, thus, reduce the ability for seasonal volume changes), and condition the soil structure to better absorb moisture and facilitate compaction. Underdrains should be installed after chemical stabilization to facilitate subsurface drainage (as discussed in Section 4.2.4.1). In the case of deeper site utilities, clay caps should be installed over the top of trench backfill prior to chemical stabilization, so the caps can be chemically treated at the same time the rest of the subgrade is treated.

Chemical stabilization and modification is most effective when the ambient air and ground temperature is at least 40 degrees and rising. Thus, chemical stabilization and modification is less commonly performed during the winter months. Furthermore, we recommend that chemical stabilization and modification occur within each successive lift of fill placed above a stabilized lift. Our experience has shown that chemically altered soils are relatively impermeable, and soil fill placed above chemically altered soils can become oversaturated during periods of inclement weather due to lack of percolation through the treated soils.

SME would be pleased to assist in developing a mix design to determine the type and amount of additive(s) required to achieve the desired results based on the soil conditions at the site, as well as assist in developing specifications to be incorporated in the project manual for bidding purposes.



## 4.3 PRELIMINARY FOUNDATION RECOMMENDATIONS

### 4.3.1 SUBGRADE VERIFICATION

To verify suitable subgrade is exposed at the bearing surface of footing excavations, and the maximum net allowable soil bearing pressure is achievable, foundation subgrades must be evaluated and tested during construction. By preparing the geotechnical evaluation report, SME is currently the geotechnical engineer of record for this project and is best-suited to observe and test the foundation subgrades during construction and to verify the recommendations of this report are properly implemented during construction.

### 4.3.2 SHALLOW FOUNDATIONS

#### 4.3.2.1 OPTION 1A (PREFERRED) – SPREAD FOOTINGS ON ROCK

**The proposed site grading plan was not provided at the time of our evaluation. Therefore, the amount and locations of cuts and fills were not identified. Based upon the test borings, presumed rock is generally shallow, with deeper rock encountered at higher elevations on the subject property. Thus, assuming the site grade is not raised substantially and/or the proposed grading requires cut of higher existing areas, it is conceivable that rock may be exposed at or near the lower levels of the site. Modification of structure design to include recessed lower levels or basements further increases the chance that rock may be encountered. There are advantages to supporting foundations directly on rock, such as (a.) reduced settlement potential, (b.) elimination of soil shrink/swell concerns, and (c.) possible reduction in foundation size (depending on structural loading conditions).**

Some over-excavation and removal of material within the rock disintegration zone (RDZ) may be necessary to remove highly fractured rock near the soil/rock interface. Typically, the zone of undercut and backfill beneath the foundations should extend laterally on a two vertical to one horizontal slope from the outside edge of the foundation. However, excavations through bedrock may be vertical provided the rock is sound and no inclined bedding planes (or other features that would indicate instability) are observed in the exposed bedrock faces.

A maximum net allowable bearing pressure of 10,000 pounds per square-foot (psf) is recommended for design of spread footing foundations bearing on sound limestone as verified during foundation construction.

For frost heave considerations, the foundation side-walls must remain vertical and not be allowed to “mushroom out” at the top during foundation concrete placement. If vertical earthen side-walls cannot be maintained, it will be necessary to slope back the foundation excavations and form foundation side-walls to maintain vertical faces for foundations and to reduce the potentially adverse effects resulting from frost heave. Expansive clays should not be placed within 2 feet horizontally of foundations or foundation stem walls due to potential for lateral expansion/movements.

The exposed bedrock at the exposed bearing elevation may be rough and difficulty may be encountered during placement of reinforcement steel. If this condition occurs, the excavation should continue to a depth just below the design bearing elevation. A leveling pad/ mud mat consisting of high strength lean concrete having a minimum 28-day compressive strength of 4,000 psi (pounds per square inch) can be placed up to the bearing elevation to provide a uniform bearing surface and accommodate reinforcement steel placement prior to foundation construction. Compacted crushed stone aggregate, soils, or excavated rock are not suitable for use below pier spread footing foundations.

Upon excavating the foundations and prior to placement of a concrete leveling mat/ mud mat (if required), we recommend a minimum of one test holes be performed in each individual pier location (and every 25 feet along the alignment of wall footings) using an air-rotary drill to probe for clay seams, void, or other discontinuities within the underlying rock mass. Test holes should extend to a minimum depth of 5 feet or

one-half footing width (B/2), whichever is greater, below the bearing elevation. If vertical joints or other rock defects are observed at the exposed bearing surface, the material may be excavated until sound rock is encountered or work may be temporarily halted until the geotechnical engineer has reviewed the bedrock condition. Placement of “dental” concrete may be considered at the discretion of the geotechnical engineer in-lieu of over-excavation and replacement. The presence of horizontal joints can lead to excessive settlement; therefore, removal of bedrock containing appreciable horizontal joints (clay filled or open) will be necessary.

We estimate that the minimum foundation size criteria may govern the size of the foundation and not the allowable soil bearing pressure. Total settlements for spread foundations bearing on sound limestone are estimated to be 0.5 inch or less. The settlement estimates provided are based on the boring information, maximum net allowable bearing pressure, our experience with similar structures and rock conditions, and field verification of suitable bearing rock by SME.

#### **4.3.2.2 OPTION 1B (PREFERRED) – MICROPILES**

As an alternative to supporting spread footings directly on rock, consideration could be given to utilizing drilled micro-piles. The micro-piles would extend through the natural soils/grade-raise fill and into the underlying limestone. A structural slab rigidly connected to the foundation system and capable of spanning the soils assuming loss of support should be utilized to reduce risk of sinkhole related subsidence below the slab. Alternatively, the subgrade below slabs could be chemically stabilized to provide some support in the event of potential support loss attributed to sinkhole activity. However, reliance on a chemically stabilized subgrade with a conventional floor slab design will incur increased risk of poor performance in comparison to a structure slab.

Micro-piles consist of high capacity small diameter drilled piles (nominally 8 to 12 inches in diameter). They utilize a high capacity threaded bar and/or threaded casing with a cement grout core. Axial capacity (compression or tension) is obtained by the bond strength between the cement grout and rock. Micro-piles can be relatively easily load tested to verify the bond strength. As such, relatively high bond strength can be used for design. For design of the micro-piles, we anticipate an ultimate bond strength of 150 psi could be used for the rock if verified by load testing. The allowable skin friction for residual/ fill soils above the bedrock/cave roof should not exceed 100 psf. The structural designer is responsible for determining the foundation size, uplift capacity, and lateral capacities.

Permanent casing will be required where micro-piles encounter voids within the soil (e.g., building at location of borings B12/B12A) or rock profiles. For micro-piles extending through large voids, the buckling capacity of the unsupported length of the steel casing should be verified.

We recommend a minimum of 10 feet into sound limestone for micro-piles. Due to unknowns regarding underlying rock conditions, expect adjustment to these depths and elevations as conditions become evident during construction. Test holes are not required for micro-piles as their capacity is based on side friction only. However, any small voids within the bond zone should be filled with low mobility grout before completing the grouting of the pile. Grout for micro-piles typically consists of cement and water with a possible fluidizer admixture. The grout is placed by pumping using a tremie tube placed at the bottom of the pile.

Settlement for the micro-piles is expected to be equal to the elastic compression of the pile above the soil rock interface.

#### **4.3.2.3 OPTION 2 – BRAB TYPE III POST-TENSIONED SLAB/FOUNDATION**

A BRAB (Building Research Advisory Board) Type III Post-tensioned (PT) slab could be considered in-lieu of a spread footing and conventional slab-on-grade. This type of system is often utilized where structural loading is light to moderate, and where high-volume change potential (i.e., fat clays) and/or soft soils exist below new foundations/slabs, and where anticipated maximum vertical rise or settlement ranges from approximately 1 to 4 inches.

BRAB Type III slabs consist of a reinforced and stiffened, integral slab-on-grade and foundation system. This type of slab is considered an intermediate step between a lightly reinforced slab (Type II) and structural slab, such as a reinforced mat (Type IV). These slabs utilize post-tensioned cables to increase the ability of the integral slab/foundation system to withstand excessive bending stress resulting from compression (i.e., settlement or shrinkage) or expansion (i.e., swelling) of the subgrade. Slabs may be designed as uniform thickness foundations or include stiffening ribs to further increase rigidity.

Improved resistance to potential localized sinkhole development is an added benefit to utilization of an integral PT slab foundation system. However, the degree of added benefit depends on many factors, including the depth of the soil profile as well as the size and location of the sinkhole feature. Utilization of a PT slab is not considered a replacement for mitigation of identified sinkhole features.

Additional laboratory and engineering analyses are required to evaluate the subgrade free swell and potential vertical rise (PVR) in addition to development of expansive soil support parameters for edge moisture distance variation ( $e_m$ ) and differential soil movement ( $y_m$ ). Differential soil movement should be evaluated using both the edge lift and center lift conditions. Furthermore, the proposed grading plan will be required for comprehensive assessment of PVR for the site.

#### **4.3.2.4 OPTION 3 – SPREAD FOOTINGS ON NATURAL SOILS OR FILL**

**Spread footings supported on natural soils or grade-raise fill may be considered provided the Owner is willing to accept the risk of potential future subsidence and/or loss of serviceability attributed to sinkhole activity.**

**Note the risk of sinkhole related subsidence is directly proportional to the rock depth below a structure at the location of a sinkhole feature. Thus, areas with a deeper soil profile (either naturally occurring or related to grade-raise fill placement) pose greater relative risk to proposed structures and other infrastructure. This option is applicable only where structures are either (a.) positioned a safe distance from identified or potential sinkhole features or (b.) identified sinkhole features are subject to further evaluation and remediated as directed by SME. Additional evaluation may include performance of excavation or additional drilling services and/or performance of targeted geophysical survey(s). BMP's would include performance of targeted geophysical surveys in any building area that is supported on a shallow soil bearing foundation system.**

No information has been provided regarding proposed site grading or the finished floor elevations (FFE) for each building. Soft clays encountered at or below the foundation levels must be undercut to suitable material and replaced with low volume change backfill such as KYTC DGA. Fat clays encountered at or near the footing levels must be undercut a minimum of 2 feet below the footing subgrade level or chemically modified/stabilized to reduce volumetric change potential. Chemical modification/stabilization will also provide some (limited) benefit from a structural support standpoint if a dropout sinkhole occurred below the foundations. Risk would be further reduced, but not eliminated, where multiple lifts of chemical modification/stabilization are performed.

**Foundations must not be supported on a combination of rock and on soil.** Rock encountered at the footing level should be undercut a minimum of 2 feet below the footing subgrade level and backfilled with engineered fill to minimize hard spots (and development of excessive bending stresses) where foundations transition between footings supported on rock/soil. The foundations for the new structure may consist of conventional shallow spread footings provided the site is prepared and filled as recommended in Section 4.

Building foundations bearing on the natural medium to stiff lean clay (CL), chemically modified soils, or engineered fill overlying the same, can be designed using a maximum net allowable soil bearing pressure of 2,000 pounds per square foot (psf) for design of the proposed shallow column and continuous (wall) foundations. The design bearing pressure provided above is based on a minimum factor-of-safety of three (for general shear failure).

Where undercutting is necessary, foundations can be constructed at the bottom of the undercut, or the design foundation bearing elevation can be re-established by placing compacted engineered fill or crushed aggregate. The foundation undercuts should be oversized laterally and backfilled with granular engineered fill or crushed aggregate (KYTC DGA) as shown on Image 1 (*Typical Foundation Undercutting Diagram*) below.

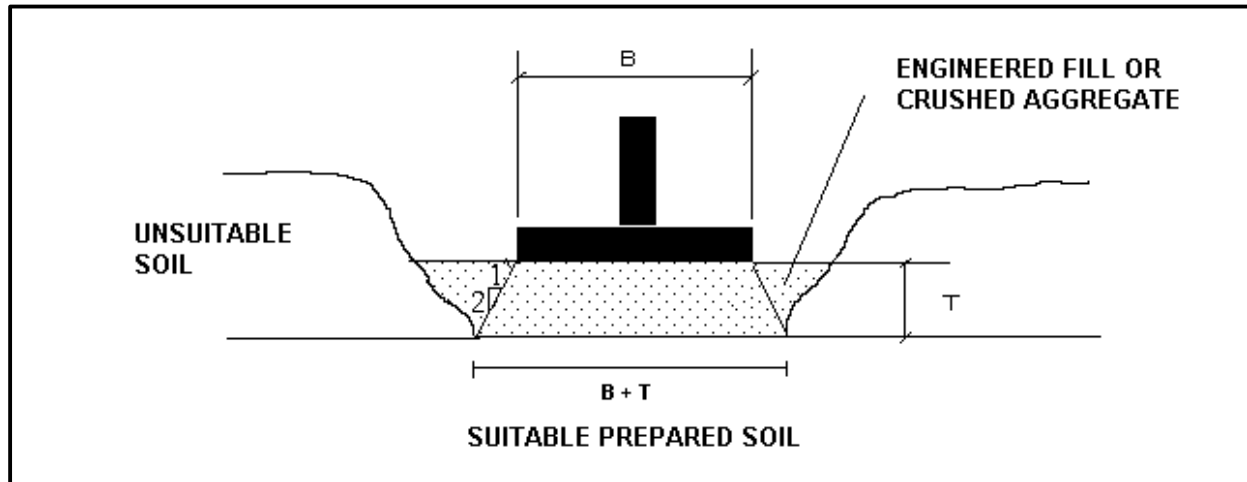

**IMAGE 1: TYPICAL FOUNDATION UNDERCUTTING DIAGRAM**

As indicated in the 2018 Kentucky Residential Code (Table 1809.5) for sites located in Jefferson County, shallow foundations must be situated a minimum of 24 inches below final site grade in any unheated areas for protection against frost action during normal winters. Foundations in interior (heated) areas of the building can be designed at shallower bearing levels on suitable soils just below the grade slab. However, the contractor must protect the foundations and proposed bearing soils from freezing during construction if work occurs in the winter months.

For frost heave considerations, vertical excavation side-walls must be maintained during foundation concrete placement and the side walls must not be allowed to “mushroom out” near the top. If vertical earthen side-walls cannot be maintained, it will be necessary to slope back the foundation excavations and form foundation side-walls to maintain vertical faces for foundations and reduce the potentially adverse effects resulting from frost heave. Caved soils must be suitably removed from the foundation bearing surfaces before placing concrete.

For bearing capacity and settlement considerations, we recommend continuous (wall) foundations have a minimum width of 18 inches and column foundations have a minimum dimension of 30 inches. In cases where structural loads are light, the minimum foundation size criteria may govern the size of the foundation and not the allowable soil bearing pressure.

Total settlements for spread foundations are estimated to be 1 inch or less and differential settlements for foundations supporting similar loads are estimated to be about one-half of the total settlement, or less. However, greater total settlements may be observed due to compression of grade-raise fill in deeper fill areas if adequate time is not provided for the consolidation settlement to occur prior to construction of the buildings. We anticipate that differential settlement will be addressed through use of control joints within the structure design. This settlement estimate is based on the boring information, recommended maximum net allowable soil bearing pressures, estimated structural loads, our experience with similar structures and soil conditions, along with field verification of suitable bearing soils by SME.

#### **4.4 SEISMIC SITE CLASSIFICATION**

Based on the referenced soil and suspect bedrock conditions averaged over the upper 100 feet of the profile, we estimate that a preliminary seismic site Class B or C applies to this site in accordance with the specifications provided by the current Kentucky Building Code and referencing Table 20.3-1 in ASCE



Standard ASCE/SEI 7-10. The appropriate seismic classification for each structure depends upon the existing soil and rock conditions, as well the proposed grading plan. SME should be provided with the final grading plan to determine the appropriate seismic site classification for individual structures.

## 4.5 BELOW-GRADE WALLS AND DRAINAGE

Below-grade walls are planned for the swimming pool. We anticipate the swimming pool walls would retain no more than 12 feet of earth. As mentioned, we were not provided finished floor elevations FFE or information regarding if the lower levels of the apartment buildings will be slab-on-grade or partially recessed. Therefore, below-grade walls could also be planned for the apartment buildings. The below-grade walls are anticipated to be supported on shallow foundations bearing on natural soils or engineered fill suitable for bearing pressure and prepared as recommended in Section 4.3 of this report.

Once final design elevations are established, SME needs to be contacted to confirm the validity of our current recommendations based on the actual bearing depths of the below-grade walls. Additionally, the walls need to be designed to effectively support the overburden weight of soil backfill, and additional lateral pressures due to surcharge loading; such as, anticipated floor or column loads, along with transient loads adjacent to the walls.

### 4.5.1 WALL BACKFILL

We recommend the retaining wall backfill immediately behind or against the wall (recommended to extend a minimum of 12 inches behind the wall) consist of an open graded well-draining granular material (e.g., Kentucky Transportation Cabinet (KYTC) No. 57 crushed aggregate) and should be compacted to in accordance with Section 4.2.5. Exercise care during compaction of the wall backfill to avoid overstressing the walls. If required, walls must be designed to accommodate the additional stresses associated with operating compaction equipment adjacent to the wall. To limit water infiltration into the granular backfill behind the wall, the upper one to two feet of the backfill should consist of compacted KYTC DGA (dense-graded aggregate) placed as engineered fill overlain by topsoil, a compacted clay cap, or covered with pavement.

### 4.5.2 LATERAL EARTH PRESSURES AND SLIDING RESISTANCE

Provided an open-graded granular material is used as backfill, a unit weight of 120 pounds per cubic foot (pcf) and a friction angle of 33 degrees can be considered for design purposes. The below-grade walls are expected to be rigid walls or restrained so they do not rotate sufficiently to permit the lower active earth pressure ( $K_a$ ) condition to be reached. Therefore, an at-rest lateral earth pressure coefficient ( $K_0$ ) of 0.45, a passive lateral earth pressure coefficient ( $K_p$ ) of 3.4, and an equivalent fluid at-rest pressure of 57 psf per foot of wall height is recommend for calculating the lateral earth pressures. This equivalent fluid pressure would increase linearly from zero (0) psf at the ground surface, to a maximum at the base of the wall.

Additional lateral pressures due to surcharge loading must be added to the above lateral earth pressures for design. Surcharge loads need to be modeled as a uniform pressure distribution applied to the entire wall height. We recommend using a horizontal coefficient for at-rest conditions, anticipating the below-grade walls will be held rigid, to calculate loads on walls due to surcharges.

### 4.5.3 DRAINAGE

The earth pressures presented above are for a drained wall backfill. To reduce the potential for the build-up of hydrostatic pressure behind the below-grade walls, we recommend foundation drains be installed along the sides of the below-grade walls retaining soil. The installation of a long-term drainage system is critical for the facility, as groundwater levels observed in the area could infiltrate the lower level depending on seasonal conditions, and the final design bearing level of the walls.

We recommend the foundation drains consist of a minimum 6 inch diameter perforated plastic drain pipe, wrapped with a filter fabric (e.g. Mirafi® 140N or 160N) and surrounded by 6 inches of a filter material, such as KYTC No. 57 crushed limestone wrapped with a filter fabric. The drains need to be connected to a sump pump system. Gravity drainage into the subgrade is not recommended, as this can encourage development of sinkhole dropouts. We recommend the design include provisions for access to the drains for cleaning and maintenance (i.e., clean-outs). Roof downspouts must not be discharged onto the ground surface above the walls. Furthermore, we recommend the drainage design include considerations for a backwashing drainage system that will allow water discharged during routine pump cleaning be directed into the sewer or storm sewer systems, if permitted by local code. Backwashing onto the subgrade (particularly in low areas where water can pond) can encourage future sinkhole development.

## 4.6 STORM-WATER MANAGEMENT BASIN

*Evaluation of conditions and recommendations for storm-water basin construction are beyond the scope of this evaluation. The discussion below is intended to provide only general considerations for development of the storm-water basin.*

No information has been made available regarding the proposed basin invert. Borings B24 and B25 (which were drilled adjacent to the proposed basin location) encountered about 3.5 feet of lean clay and fat clay below existing site grade underlain by sands and apparent rock. For construction purposes, the soils encountered in the boring near the proposed storm-water management basin should be readily excavated using conventional earthwork equipment. However, depending on seasonal conditions, localized and sporadic groundwater infiltration should be expected to be encountered in the basin excavation. Storage capacity could also be limited by the presence of limestone or rock pinnacles. Therefore, care should be taken when evaluating the design size and capacity of the basin for temporary storage of stormwater.

The in situ clays are estimated to have relatively low permeability characteristics and are considered favorable for the design of retention basins; as they have the potential to retain water for a prolonged amount of time. The underlying sands have higher permeability characteristics which are not favorable for retention. Therefore, it is likely that the subsurface conditions at the basin location are not favorable for prolonged retention of water without a liner, as a clay cap alone may not successfully provide long-term impoundment of water at this site. The undulating and pinnacled limestone rock surface could result in portions of the clay cap being thinner than required for permanent or temporary impoundment. SME can provide additional recommendations for storm-water management basin construction upon request.

As mentioned in our Karst Reconnaissance Survey report (SME Project No. 088601.00) dated March 7, 2022, ponds such as the existing basin typically form in low points in karst areas via plugging of the near-surface voids or fracture zones via siltation. Collection of surface water in karst areas can further encourage development of incipient sinkhole activity.

## 4.7 CONSTRUCTION CONSIDERATIONS

### 4.7.1 KARST CONSIDERATIONS

#### 4.7.1.1 PLANNING CONSIDERATIONS

There is some risk associated with constructing on karst terrain. A quantitative risk assessment is difficult to provide due to the complex nature of karst topography, but general qualitative assessments can be provided. Subsidence caused by karst features can result in excessive and uneven settlement of structures and structural distress requiring underpinning or replacement of foundations, replacement of grade slabs and pavements, or other structural remedies. However, this risk can be managed to a practical degree by implemented best-management-practices (BMPs) that minimize surface water intrusion into the subgrade, such as:

- Direct surface water away from structural areas.

- Construct quality joints for utilities to minimize water leakage. Seal joints outside the utilities with concrete or flowable fill.
- Divert water collected in roof downspouts away from buildings.
- Do not install/use sprinkler systems next to the building or foundation areas.
- Engage a local geotechnical engineer or engineering geologist to check the subgrade for indications of solution activity after cut areas are excavated to grade and before fill is placed in fill areas.
- Routinely monitor structures that impound water for possible leaks.

Where structures are rock bearing, the risk of sinkhole related subsidence is reduced. A higher risk is associated with leaking or ruptured water or sewer utilities (or tank structures), which would divert water directly into the subgrade below soil bearing structures or below utilities. Consider encasing below-grade utilities in flowable fill to reduce the potential for sinkhole development should utility rupture occur.

#### **4.7.1.2 SINKHOLE MITIGATION**

Identified sinkhole features located in or directly adjacent to proposed infrastructure (e.g., buildings or pavements) will require remediation prior to construction or placement of grade-raise fill (if anticipated). At minimum, sinkhole remediation is expected for the feature located in the building near the southwest corner of the site (near boring B1) and possibly near the location of boring B9. Furthermore, the subsurface void encountered in borings B12 and B12A will require remediation after further exploration of the feature.

Typical solutions for relatively shallow sinkholes include construction of graded inverted filters or reinforced concrete caps spanning the solution opening. Remedial solution development must be determined on an individual basis for each identified sinkhole or karst feature and pending additional evaluation and recommendations by SME. The appropriate solution will consider the proposed construction and the Owner's acceptable level of risk.

#### **4.7.1.3 MONITORING CONSIDERATIONS**

Instrumentation could be installed within the building footprints to provide continual real-time monitoring for possible ground subsidence utilizing the SinkholeAlert system developed by G3 Group. A sinkhole monitoring should be considered where foundations/ slabs are designed as soil supported, particularly where the soil profile below the building is relatively deep.

This type of system consists of installing well casing with sensor probe implants attached to a cable at desired locations and depths. The sensor utilizes time-domain reflectometry technology to evaluate potential ground movements. The sensor is tripped in the event subsidence occurs below and at the sensor probe, which severs the wire connection and sends a signal to the monitoring device. The monitoring device connects to an alarm panel siren or other triggering device. Text messages and/or phone calls can be sent by the system in real-time to notify the Owner if ground subsidence is detected. A fee applies for monitoring services.

There are some limitations in utilization of this equipment. This technology performs optimally in sandy soils as opposed to clay soils (which dominate soil stratigraphy at this site) due to the differences in the way ground movements occur during dropout sinkhole formation. Additionally, the recommended horizontal probe sensor spacing is typically directly related to the depth to rock. Therefore, an impractical number of sensors may be necessary to cover the footprint of a facility with shallower rock conditions. Furthermore, this is a passive monitoring technique and does not provide protection from sinkhole related subsidence; it is merely an early detection system. Utilization of a sinkhole monitoring system is not considered a suitable replacement for remediation identified sinkholes or other karst features.

There are also some options for subgrade and/or building monitoring that could be implemented in an effort to potentially detect possible ground subsidence/settlement in the future. One option would be to install a series of settlement plates that are below the new structures and are readily accessible after construction is complete (e.g., via removing flush mounted covers over small core holes in the slab). The flush mounted covers can be removed to record subgrade movement (if any) using survey equipment. However, this approach can be limited, or ineffective, in providing advance notice of a sinkhole, depending upon how a future sinkhole would reach the surface. We would be pleased to discuss options for monitoring subgrade conditions after construction as a proactive approach to the building's operations and maintenance program, if desired.

#### 4.7.2 GENERAL CONSTRUCTION CONSIDERATIONS

The near-surface soils present at the site are moisture sensitive and susceptible to disturbance if they become wet and are trafficked by construction equipment. It will likely be more difficult and costly to attempt construction at this site during periods of seasonally cooler and/or wet weather. The warmer summer months will be the optimal time period to perform earthwork activities at this site in order to reduce disturbance of the existing soils, and the need for undercutting of disturbed materials and subgrade remediation. Subgrade stabilization using coarse crushed aggregates and geo-fabrics, and construction of dedicated construction roads, may be necessary to facilitate construction at this site. If subgrade preparation occurs during periods of adverse weather, chemical subgrade modification or stabilization could help reduce subgrade disturbance.

Engineered fill slopes should be constructed no steeper than 3H:1V unless retaining walls are utilized. Benching will be required to tie in grade-raise fill into existing slopes. Benches should be cut wide enough to accommodate excavation equipment and accommodate fill placement. In general, excavations to key in new fill should begin at the top of the slope and proceed downwards. Backfilling of fill areas should begin at the lowest bench and proceed upwards. Contact SME for additional direction if water seepage or spring activity is observed during slope benching/ fill placement.

Chemical soil modification or stabilization will require additional laboratory analysis to evaluate the appropriate chemical agent type, reactivity, and quantity required for modification or stabilization. Part of this analysis will include evaluation for sulfates within the existing soils. Soils containing excessive sulfates can experience additional expansion after chemical treatment and may not be suitable for chemical treatment. Based upon the Atterberg Limits tests performed for this evaluation, we preliminarily estimate that treatment with quicklime or lime by-products (e.g., hydrated lime or lime kiln dust) will effectively reduce soil plasticity properties. Higher plasticity soils may require treatment with quicklime only.

The contractor must protect adjacent existing buildings, utilities, and roadways during construction of the proposed building and site improvements. During the excavating and compacting operations, excessive vibrations should not cause settlement of the existing buildings, utilities, and roadways, and the contractor should avoid undermining existing buildings, utilities, and roadways. Excavations should not extend below existing foundations without first properly underpinning or shoring the existing foundations. In areas where there is insufficient space to temporarily slope back excavations in accordance with applicable regulations, temporary earth retention systems will be required during construction. Underpinning, shoring and earth retention systems should be designed by a qualified professional engineer, and installed by a contractor experienced with construction of these systems.

At locations directly adjacent to the proposed construction, we recommend performing a pre-existing condition survey to assess and document the existing condition of the adjacent buildings/residential dwellings. The pre-existing condition survey should include photography, videography, and elevation monitoring of the existing structure. A pre-existing structural condition assessment and vibration monitoring during construction could also be considered. We recommend reviewing the condition of the existing building at critical phases during construction and performing a post-construction condition survey to assist in evaluating whether distress to the existing structure occurred during construction. Contact SME for more information about pre-existing condition surveys, structural assessments, and/or vibration monitoring during construction.

The contractor must provide safely sloped excavations or an adequately constructed and braced shoring system in accordance with federal, state, and local safety regulations for individuals working in an excavation that may expose them to the danger of moving ground. If material is stored or heavy equipment is operated near an excavation, use appropriate shoring to resist the extra pressure due to the superimposed loads.

Excavations are not anticipated to extend below the depth of groundwater; however, water seepage into shallow foundation and utility excavations may occur during construction. We anticipate standard sump pit and pump methods should generally be adequate to control groundwater on a localized and temporary basis for excavations, as needed.

Handling, transportation, and disposal of excavated materials and groundwater should be performed in accordance with applicable environmental regulations.

## 5. SIGNATURES

### Report prepared by:

Michael Hammond, PE (IN)  
Project Engineer

### Report reviewed by:

Timothy H. Bedenis, PE (IN, MI), D.GE  
Principal Consultant

Wesley J. Hemp, PE, PG (LA), LEED AP  
Senior Project Engineer

## **APPENDIX A**

**BORING LOCATION DIAGRAM (FIGURE NO. 1)**

**IDENTIFIED KARST FEATURE OVERLAY MAP (FIGURE NO. 2)**

**BORING LOG TERMINOLOGY**

**BORING LOGS (B1 THROUGH B31)**



\\sme-inc\p\WIP\088601.00\CAD\Design Files\BLD\Rev\0\088601.00-BLD.dwg

PLOT DATE: Apr 06, 2022 - 4:28pm - julie.blake

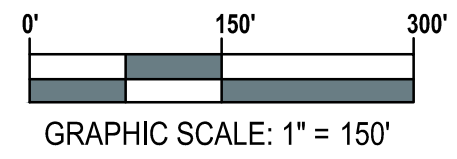
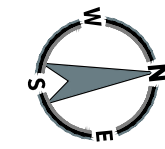
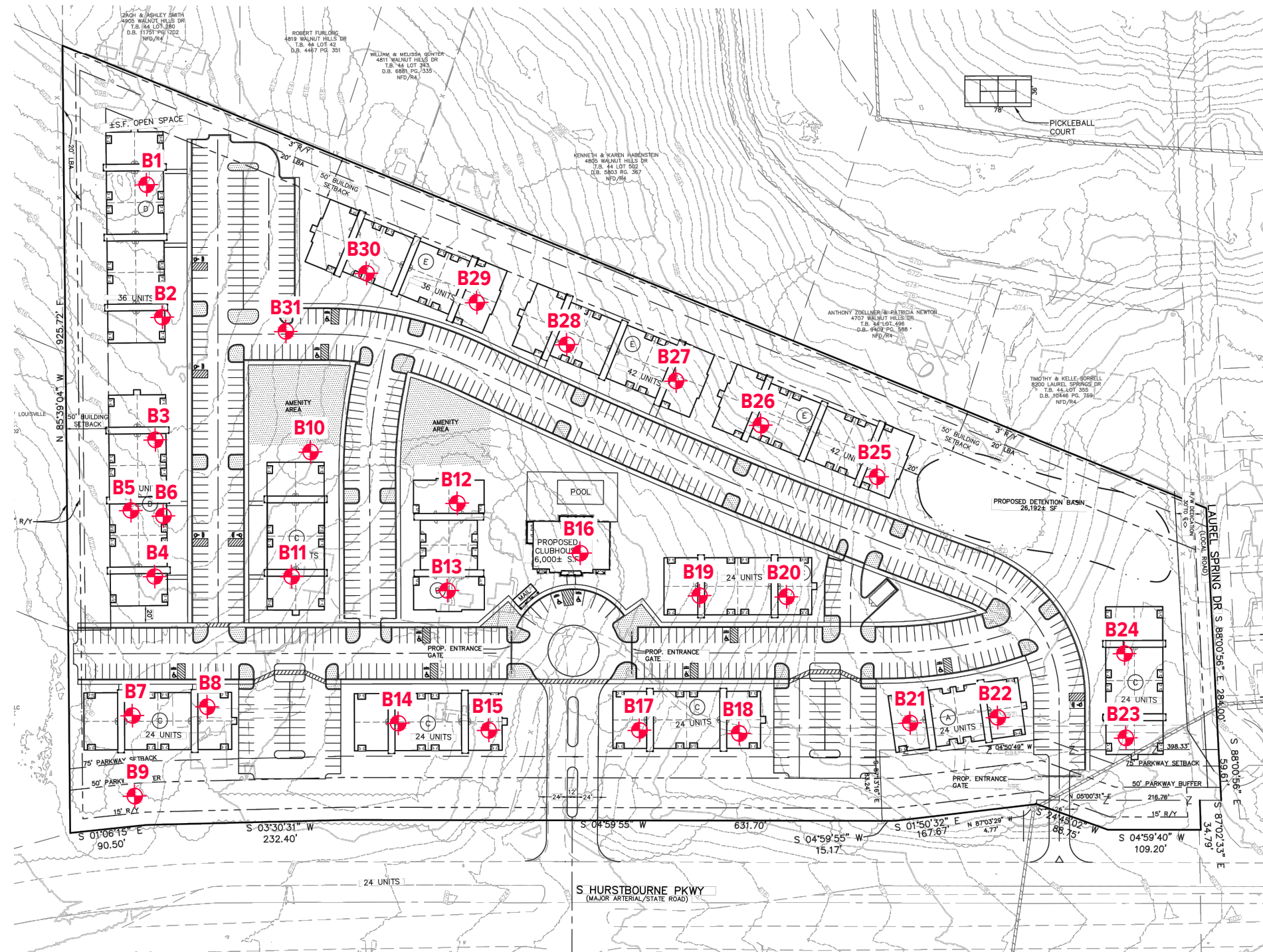

**LEGEND**

 APPROXIMATE BORING LOCATION

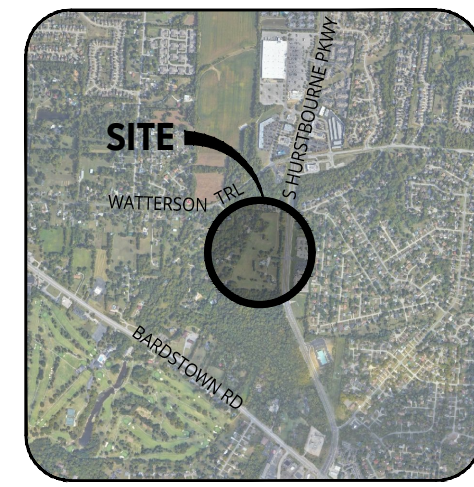

**LOCATION MAP**  
NOT TO SCALE

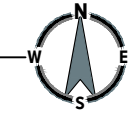

NOTE:  
1. BASE DRAWING INFORMATION TAKEN FROM A PDF/DRAWING TITLED "PRE-APPLICATION/DETAILED DISTRICT DEVELOPMENT PLAN" PREPARED BY MINDEL SCOTT, DATED 11/29/2021.



**Project**  
**HURSTBOURNE APARTMENTS DEVELOPMENT**

**Project Location**  
**LOUISVILLE, KENTUCKY**

**Sheet Name**  
**BORING LOCATION DIAGRAM**

| No. | Revision Date |
|-----|---------------|
|     |               |
|     |               |
|     |               |

|          |           |
|----------|-----------|
| Date     | 4/6/2022  |
| CADD     | JAB       |
| Designer | MJH       |
| Scale    | AS NOTED  |
| Project  | 088601.00 |

Figure No.  
**1**

DRAWING NOTE: SCALE DEPICTED IS MEANT FOR 11" X 17" AND WILL SCALE INCORRECTLY IF PRINTED ON ANY OTHER SIZE MEDIA  
NO REPRODUCTION SHALL BE MADE WITHOUT THE PRIOR CONSENT OF SME  
© 2022



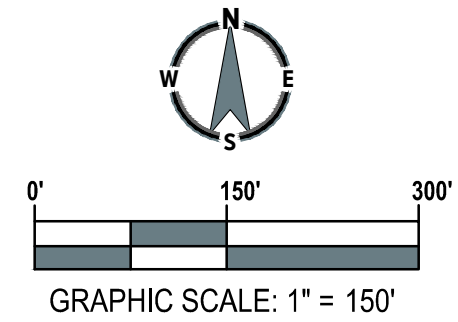
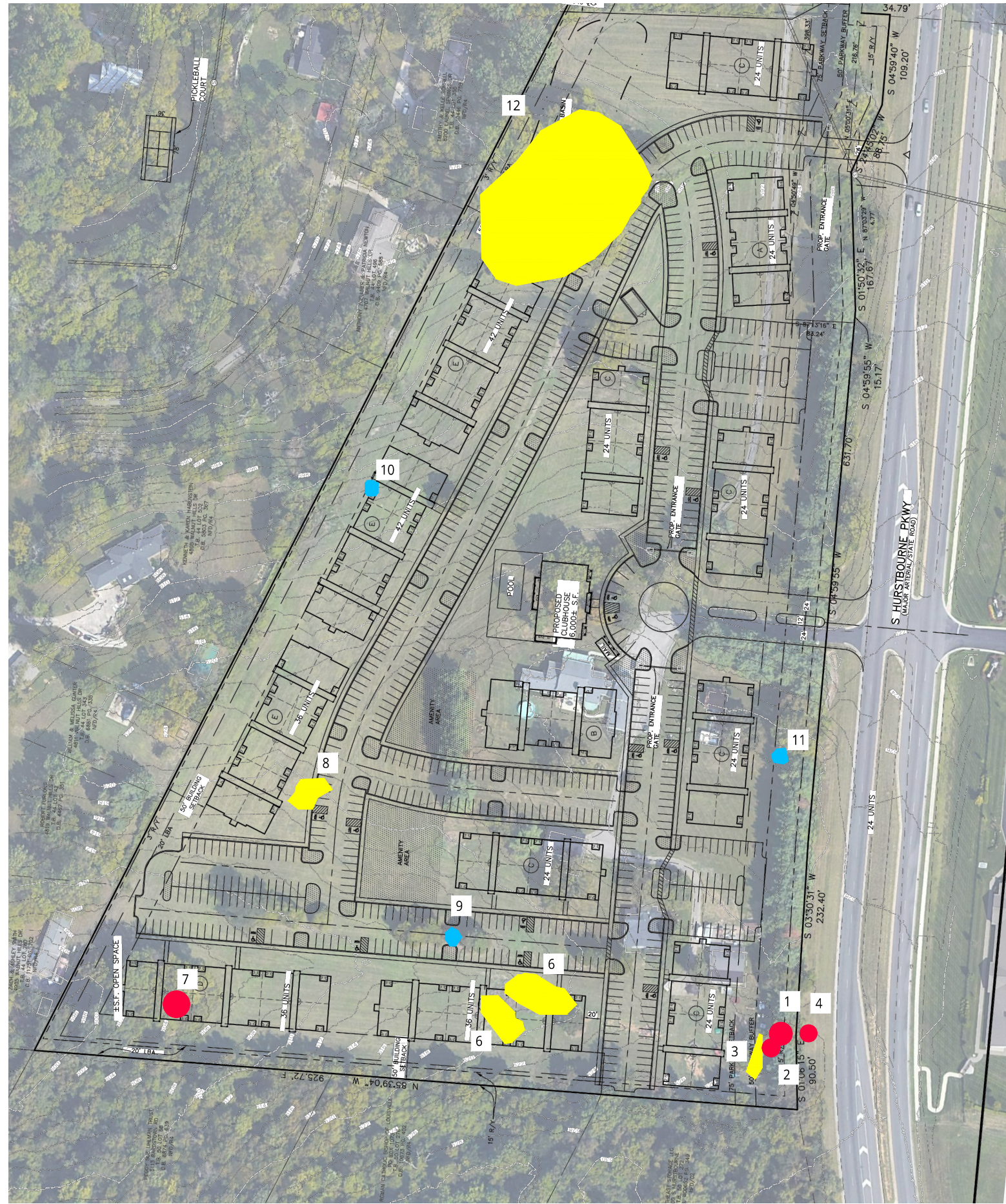

**LEGEND**

- APPROXIMATE LOCATION OF SUBSIDENCE AREA OR SUSPECTED DOLINE
- APPROXIMATE LOCATION OF IDENTIFIED SINKHOLE OR THROAT
- APPROXIMATE LOCATION OF CONDUIT OR ANIMAL BURROW



**LOCATION MAP**  
NOT TO SCALE

- NOTES:
1. BASE DRAWING INFORMATION TAKEN FROM A PDF/DRAWING TITLED "PRE-APPLICATION/DETAILED DISTRICT DEVELOPMENT PLAN" PREPARED BY MINDEL SCOTT, DATED 11/29/202.
  2. AERIAL IMAGE TAKEN FROM GOOGLE EARTH PRO WITH AN IMAGE DATE OF 09/02/2019.
  3. KARST TOPOGRAPHY LAYOUT TAKEN FROM A PDF TITLED "KARST RECONNAISSANCE SURVEY" PREPARED BY SME, DATED 03/07/2022



Project  
**HURSTBOURNE APARTMENTS DEVELOPMENT**

Project Location  
**LOUISVILLE, KENTUCKY**

Sheet Name  
**IDENTIFIED KARST FEATURE OVERLAY MAP**

| No. | Revision Date |
|-----|---------------|
|     |               |
|     |               |
|     |               |

Date **04/13/2022**

CADD **TPM**

Designer **WJH**

Scale **AS NOTED**















Project **088601.00**













Figure No.  
**2**

DRAWING NOTE: SCALE DEPICTED IS MEANT FOR 11" X 17" AND WILL SCALE INCORRECTLY IF PRINTED ON ANY OTHER SIZE MEDIA  
NO REPRODUCTION SHALL BE MADE WITHOUT THE PRIOR CONSENT OF SME  
© 2022



# BORING LOG TERMINOLOGY

| UNIFIED SOIL CLASSIFICATION AND SYMBOL CHART                                                 |                                                                                     |                                                                           |
|----------------------------------------------------------------------------------------------|-------------------------------------------------------------------------------------|---------------------------------------------------------------------------|
| <b>COARSE-GRAINED SOIL</b><br>(more than 50% of material is larger than No. 200 sieve size.) |                                                                                     |                                                                           |
| Clean Gravel (Less than 5% fines)                                                            |                                                                                     |                                                                           |
| <b>GRAVEL</b><br>More than 50% of coarse fraction larger than No. 4 sieve size               |    | GW Well-graded gravel; gravel-sand mixtures, little or no fines           |
|                                                                                              |    | GP Poorly-graded gravel; gravel-sand mixtures, little or no fines         |
|                                                                                              | Gravel with fines (More than 12% fines)                                             |                                                                           |
|                                                                                              |    | GM Silty gravel; gravel-sand-silt mixtures                                |
|                                                                                              |    | GC Clayey gravel; gravel-sand-clay mixtures                               |
| Clean Sand (Less than 5% fines)                                                              |                                                                                     |                                                                           |
| <b>SAND</b><br>50% or more of coarse fraction smaller than No. 4 sieve size                  |    | SW Well-graded sand; sand-gravel mixtures, little or no fines             |
|                                                                                              |    | SP Poorly graded sand; sand-gravel mixtures, little or no fines           |
|                                                                                              | Sand with fines (More than 12% fines)                                               |                                                                           |
|                                                                                              |    | SM Silty sand; sand-silt-gravel mixtures                                  |
|                                                                                              |    | SC Clayey sand; sand-clay-gravel mixtures                                 |
| <b>FINE-GRAINED SOIL</b><br>(50% or more of material is smaller than No. 200 sieve size)     |                                                                                     |                                                                           |
| <b>SILT AND CLAY</b><br>Liquid limit less than 50%                                           |    | ML Inorganic silt; sandy silt or gravelly silt with slight plasticity     |
|                                                                                              |    | CL Inorganic clay of low plasticity; lean clay, sandy clay, gravelly clay |
|                                                                                              |    | OL Organic silt and organic clay of low plasticity                        |
| <b>SILT AND CLAY</b><br>Liquid limit 50% or greater                                          |   | MH Inorganic silt of high plasticity, elastic silt                        |
|                                                                                              |  | CH Inorganic clay of high plasticity, fat clay                            |
|                                                                                              |  | OH Organic silt and organic clay of high plasticity                       |
| <b>HIGHLY ORGANIC SOIL</b>                                                                   |  | PT Peat and other highly organic soil                                     |

| OTHER MATERIAL SYMBOLS                                                             |                                                                                     |                                                                                     |
|------------------------------------------------------------------------------------|-------------------------------------------------------------------------------------|-------------------------------------------------------------------------------------|
|  |  |  |
|  |  |  |
|  |  |  |
|  |  |  |

| LABORATORY CLASSIFICATION CRITERIA |                                                                                                             |
|------------------------------------|-------------------------------------------------------------------------------------------------------------|
| GW                                 | $C_u = \frac{D_{60}}{D_{10}}$ greater than 4; $C_c = \frac{D_{30}^2}{D_{10} \times D_{60}}$ between 1 and 3 |
| GP                                 | Not meeting all gradation requirements for GW                                                               |
| GM                                 | Atterberg limits below "A" line or PI less than 4                                                           |
| GC                                 | Atterberg limits above "A" line with PI greater than 7                                                      |
| SW                                 | $C_u = \frac{D_{60}}{D_{10}}$ greater than 6; $C_c = \frac{D_{30}^2}{D_{10} \times D_{60}}$ between 1 and 3 |
| SP                                 | Not meeting all gradation requirements for SW                                                               |
| SM                                 | Atterberg limits below "A" line or PI less than 4                                                           |
| SC                                 | Atterberg limits above "A" line with PI greater than 7                                                      |

Determine percentages of sand and gravel from grain-size curve. Depending on percentage of fines (fraction smaller than No. 200 sieve size), coarse-grained soils are classified as follows:

Less than 5 percent.....GW, GP, SW, SP  
 More than 12 percent.....GM, GC, SM, SC  
 5 to 12 percent.....Cases requiring dual symbols

- SP-SM or SW-SM (SAND with Silt or SAND with Silt and Gravel)
- SP-SC or SW-SC (SAND with Clay or SAND with Clay and Gravel)
- GP-GM or GW-GM (GRAVEL with Silt or GRAVEL with Silt and Sand)
- GP-GC or GW-GC (GRAVEL with Clay or GRAVEL with Clay and Sand)

If the fines are CL-ML:

- SC-SM (SILTY CLAYEY SAND or SILTY CLAYEY SAND with Gravel)
- SM-SC (CLAYEY SILTY SAND or CLAYEY SILTY SAND with Gravel)
- GC-GM (SILTY CLAYEY GRAVEL or SILTY CLAYEY GRAVEL with Sand)

| PARTICLE SIZES |                          |
|----------------|--------------------------|
| Boulders       | - Greater than 12 inches |
| Cobbles        | - 3 inches to 12 inches  |
| Gravel- Coarse | - 3/4 inches to 3 inches |
| Gravel- Fine   | - No. 4 to 3/4 inches    |
| Sand- Coarse   | - No. 10 to No. 4        |
| Sand- Medium   | - No. 40 to No. 10       |
| Sand- Fine     | - No. 200 to No. 40      |
| Silt and Clay  | - Less than (0.0074 mm)  |

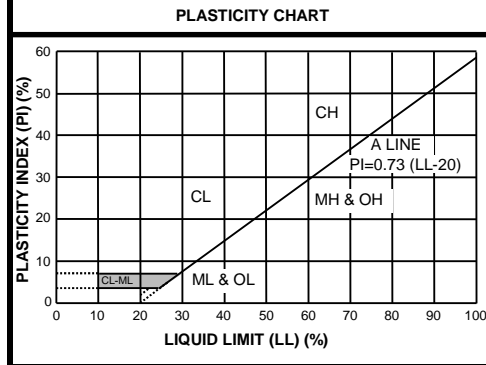

| VISUAL MANUAL PROCEDURE                                                                                                                                                                                                                                                                                                                                                                                                                                                                                                                                                                                              |
|----------------------------------------------------------------------------------------------------------------------------------------------------------------------------------------------------------------------------------------------------------------------------------------------------------------------------------------------------------------------------------------------------------------------------------------------------------------------------------------------------------------------------------------------------------------------------------------------------------------------|
| When laboratory tests are not performed to confirm the classification of soils exhibiting borderline classifications, the two possible classifications would be separated with a slash, as follows:                                                                                                                                                                                                                                                                                                                                                                                                                  |
| For soils where it is difficult to distinguish if it is a coarse or fine-grained soil:                                                                                                                                                                                                                                                                                                                                                                                                                                                                                                                               |
| <ul style="list-style-type: none"> <li>• SC/CL (CLAYEY SAND to Sandy LEAN CLAY)</li> <li>• SM/ML (SILTY SAND to SANDY SILT)</li> <li>• GC/CL (CLAYEY GRAVEL to Gravelly LEAN CLAY)</li> <li>• GM/ML (SILTY GRAVEL to Gravelly SILT)</li> </ul>                                                                                                                                                                                                                                                                                                                                                                       |
| For soils where it is difficult to distinguish if it is sand or gravel, poorly or well-graded sand or gravel; silt or clay; or plastic or non-plastic silt or clay:                                                                                                                                                                                                                                                                                                                                                                                                                                                  |
| <ul style="list-style-type: none"> <li>• SP/GP or SW/GW (SAND with Gravel to GRAVEL with Sand)</li> <li>• SC/GC (CLAYEY SAND with Gravel to CLAYEY GRAVEL with Sand)</li> <li>• SM/GM (SILTY SAND with Gravel to SILTY GRAVEL with Sand)</li> <li>• SW/SP (SAND or SAND with Gravel)</li> <li>• GP/GW (GRAVEL or GRAVEL with Sand)</li> <li>• SC/SM (CLAYEY to SILTY SAND)</li> <li>• GM/GC (SILTY to CLAYEY GRAVEL)</li> <li>• CL/ML (SILTY CLAY)</li> <li>• ML/CL (CLAYEY SILT)</li> <li>• CH/MH (FAT CLAY to ELASTIC SILT)</li> <li>• CL/CH (LEAN to FAT CLAY)</li> <li>• MH/ML (ELASTIC SILT to SILT)</li> </ul> |

| DRILLING AND SAMPLING ABBREVIATIONS |                                                                |
|-------------------------------------|----------------------------------------------------------------|
| 2ST                                 | - Shelby Tube - 2" O.D.                                        |
| 3ST                                 | - Shelby Tube - 3" O.D.                                        |
| AS                                  | - Auger Sample                                                 |
| GS                                  | - Grab Sample                                                  |
| LS                                  | - Liner Sample                                                 |
| NR                                  | - No Recovery                                                  |
| PM                                  | - Pressure Meter                                               |
| RC                                  | - Rock Core diamond bit. NX size, except where noted           |
| SB                                  | - Split Barrel Sample 1-3/8" I.D., 2" O.D., except where noted |
| VS                                  | - Vane Shear                                                   |
| WS                                  | - Wash Sample                                                  |

| OTHER ABBREVIATIONS |                           |
|---------------------|---------------------------|
| WOH                 | - Weight of Hammer        |
| WOR                 | - Weight of Rods          |
| SP                  | - Soil Probe              |
| PID                 | - Photo Ionization Device |
| FID                 | - Flame Ionization Device |

| DEPOSITIONAL FEATURES |                                                                                                                                       |
|-----------------------|---------------------------------------------------------------------------------------------------------------------------------------|
| Parting               | - as much as 1/16 inch thick                                                                                                          |
| Seam                  | - 1/16 inch to 1/2 inch thick                                                                                                         |
| Layer                 | - 1/2 inch to 12 inches thick                                                                                                         |
| Stratum               | - greater than 12 inches thick                                                                                                        |
| Pocket                | - deposit of limited lateral extent                                                                                                   |
| Lens                  | - lenticular deposit                                                                                                                  |
| Hardpan/Till          | - an unstratified, consolidated or cemented mixture of clay, silt, sand and/or gravel, the size/shape of the constituents vary widely |
| Lacustrine            | - soil deposited by lake water                                                                                                        |
| Mottled               | - soil irregularly marked with spots of different colors that vary in number and size                                                 |
| Varved                | - alternating partings or seams of silt and/or clay                                                                                   |
| Occasional            | - one or less per foot of thickness                                                                                                   |
| Frequent              | - more than one per foot of thickness                                                                                                 |
| Interbedded           | - strata of soil or beds of rock lying between or alternating with other strata of a different nature                                 |

| DESCRIPTION OF RELATIVE QUANTITIES                                                                                                            |                                                          |
|-----------------------------------------------------------------------------------------------------------------------------------------------|----------------------------------------------------------|
| The visual-manual procedure uses the following terms to describe the relative quantities of notable foreign materials, gravel, sand or fines: |                                                          |
| Trace                                                                                                                                         | - particles are present but estimated to be less than 5% |
| Few                                                                                                                                           | - 5 to 10%                                               |
| Little                                                                                                                                        | - 15 to 25%                                              |
| Some                                                                                                                                          | - 30 to 45%                                              |
| Mostly                                                                                                                                        | - 50 to 100%                                             |

| CLASSIFICATION TERMINOLOGY AND CORRELATIONS                                                                                                                                                                                                                       |                                                      |                                                       |                                                      |
|-------------------------------------------------------------------------------------------------------------------------------------------------------------------------------------------------------------------------------------------------------------------|------------------------------------------------------|-------------------------------------------------------|------------------------------------------------------|
| <b>Cohesionless Soils</b>                                                                                                                                                                                                                                         |                                                      | <b>Cohesive Soils</b>                                 |                                                      |
| <b>Relative Density</b>                                                                                                                                                                                                                                           | <b>N<sub>60</sub> (N-Value)<br/>(Blows per foot)</b> | <b>Consistency</b>                                    | <b>N<sub>60</sub> (N-Value)<br/>(Blows per foot)</b> |
| Very Loose                                                                                                                                                                                                                                                        | 0 to 4                                               | Very Soft                                             | <2                                                   |
| Loose                                                                                                                                                                                                                                                             | 5 to 10                                              | Soft                                                  | 2 - 4                                                |
| Medium Dense                                                                                                                                                                                                                                                      | 11 to 30                                             | Medium                                                | 5 - 8                                                |
| Dense                                                                                                                                                                                                                                                             | 31 to 50                                             | Stiff                                                 | 9 - 15                                               |
| Very Dense                                                                                                                                                                                                                                                        | 51 to 80                                             | Very Stiff                                            | 16 - 30                                              |
| Extremely Dense                                                                                                                                                                                                                                                   | Over 81                                              | Hard                                                  | > 30                                                 |
|                                                                                                                                                                                                                                                                   |                                                      | <b>Undrained Shear Strength (kips/ft<sup>2</sup>)</b> |                                                      |
|                                                                                                                                                                                                                                                                   |                                                      | < 0.25                                                | 0.25 or less                                         |
|                                                                                                                                                                                                                                                                   |                                                      | > 0.25 to 0.50                                        | > 0.25 to 0.50                                       |
|                                                                                                                                                                                                                                                                   |                                                      | > 0.50 to 1.0                                         | > 0.50 to 1.0                                        |
|                                                                                                                                                                                                                                                                   |                                                      | > 1.0 to 2.0                                          | > 1.0 to 2.0                                         |
|                                                                                                                                                                                                                                                                   |                                                      | > 2.0 to 4.0                                          | > 2.0 to 4.0                                         |
|                                                                                                                                                                                                                                                                   |                                                      | > 4.0 or greater                                      | > 4.0 or greater                                     |
| Standard Penetration 'N-Value' = Blows per foot of a 140-pound hammer falling 30 inches on a 2-inch O.D. split barrel sampler, except where noted. N <sub>60</sub> values as reported on boring logs represent raw N-values corrected for hammer efficiency only. |                                                      |                                                       |                                                      |

4/22/22 3:51:23 PM



# BORING B 1

PAGE 1 OF 1

BORING DEPTH: 7.9 FEET

**PROJECT NAME:** Hurstbourne Apartments Development

**PROJECT NUMBER:** 088601.00

**CLIENT:** Kennedy International, Inc

**PROJECT LOCATION:** Louisville, Kentucky

**DATE STARTED:** 3/14/22

**COMPLETED:** 3/14/22

**BORING METHOD:** Hollow-stem Augers

**DRILLER:** JK (Strata)

**RIG NO.:** 7822DT

**LOGGED BY:** JWJ

**CHECKED BY:** AEB

| DEPTH (FEET) | SYMBOLIC PROFILE | PROFILE DESCRIPTION                             | SAMPLE TYPE/NO. INTERVAL | RECOVERY LENGTH (INCHES) | SPT BLOWS PER SIX INCHES | HAMMER EFFICIENCY: 60%<br>DATE:<br>N <sub>60</sub> -- O | DRY DENSITY (pcf) -- ■ |     | MOISTURE & ATTERBERG LIMITS (%) |     | ▼ HAND PENE.<br>■ TORVANE SHEAR<br>○ UNC. COMP.<br>□ VANE SHEAR (PK)<br>× VANE SHEAR (REM)<br>◆ TRIAXIAL (UU) SHEAR<br>STRENGTH (KSF) | REMARKS                    |
|--------------|------------------|-------------------------------------------------|--------------------------|--------------------------|--------------------------|---------------------------------------------------------|------------------------|-----|---------------------------------|-----|---------------------------------------------------------------------------------------------------------------------------------------|----------------------------|
|              |                  |                                                 |                          |                          |                          |                                                         | 90                     | 100 | 110                             | 120 |                                                                                                                                       |                            |
| 0            |                  | 9 inches of TOPSOIL                             |                          |                          |                          |                                                         |                        |     |                                 |     |                                                                                                                                       |                            |
| 0.8          |                  |                                                 | SB1                      | 17                       | 1                        | 2                                                       |                        |     | 26                              |     |                                                                                                                                       |                            |
| 3.5          |                  |                                                 | SB2                      | 15                       | 1                        | 7                                                       |                        |     | 24                              |     |                                                                                                                                       |                            |
| 5            |                  |                                                 | SB3                      | 12                       | 4                        | 16                                                      |                        |     | 26                              |     |                                                                                                                                       |                            |
| 7.8          |                  |                                                 | SB4                      | 1                        | 10                       | 50+                                                     |                        |     |                                 |     |                                                                                                                                       |                            |
| 7.9          |                  | Highly to Completely Weathered SANDSTONE- Brown |                          |                          |                          |                                                         |                        |     |                                 |     |                                                                                                                                       | Auger refusal at 7.8 feet. |
|              |                  | END OF BORING AT 7.9 FEET.                      |                          |                          |                          |                                                         |                        |     |                                 |     |                                                                                                                                       |                            |

**GROUNDWATER & BACKFILL INFORMATION**

GROUNDWATER WAS NOT ENCOUNTERED

**BACKFILL METHOD:** Auger Cuttings

NOTES: 1. The indicated stratification lines are approximate. The in-situ transitions between materials may be gradual.  
 2. The colors depicted on the symbolic profile are solely for visualization purposes and do not necessarily represent the in-situ colors encountered.  
 3. No hammer efficiency data was available, and the graphic output illustrates the field measured blow counts.

4/22/22 3:51:24 PM



# BORING B 1A

PAGE 1 OF 1

BORING DEPTH: 5 FEET

**PROJECT NAME:** Hurstbourne Apartments Development

**PROJECT NUMBER:** 088601.00

**CLIENT:** Kennedy International, Inc

**PROJECT LOCATION:** Louisville, Kentucky

**DATE STARTED:** 3/14/22

**COMPLETED:** 3/14/22

**BORING METHOD:** Hollow-stem Augers

**DRILLER:** JK (Strata)

**RIG NO.:** 7822DT

**LOGGED BY:** JWJ

**CHECKED BY:** AEB

| DEPTH (FEET) | SYMBOLIC PROFILE | PROFILE DESCRIPTION                                                                                               | SAMPLE TYPE/NO. INTERVAL | RECOVERY LENGTH (INCHES) | HAMMER EFFICIENCY: 60%<br>DATE:<br>N <sub>60</sub> -- O | DRY DENSITY (pcf) -- ■ | MOISTURE & ATTERBERG LIMITS (%) | <input type="checkbox"/> HAND PENE.<br><input type="checkbox"/> TORVANE SHEAR<br><input type="checkbox"/> UNC. COMP.<br><input type="checkbox"/> VANE SHEAR (PK)<br><input type="checkbox"/> VANE SHEAR (REM)<br><input type="checkbox"/> TRIAXIAL (UU) SHEAR<br>STRENGTH (KSF) | REMARKS |
|--------------|------------------|-------------------------------------------------------------------------------------------------------------------|--------------------------|--------------------------|---------------------------------------------------------|------------------------|---------------------------------|---------------------------------------------------------------------------------------------------------------------------------------------------------------------------------------------------------------------------------------------------------------------------------|---------|
|              |                  |                                                                                                                   |                          |                          |                                                         | 90 100 110 120         |                                 |                                                                                                                                                                                                                                                                                 |         |
| 0            |                  | Blind Drilled to 3 Feet. See Boring B1 for Soil Information.                                                      |                          |                          |                                                         |                        |                                 |                                                                                                                                                                                                                                                                                 |         |
| 3.0          |                  | Shelby Tube Was Not Extruded to Preserve Sample for Potential Future Testing. See Boring B1 for Soil Information. | 3ST1                     | 18                       |                                                         |                        |                                 |                                                                                                                                                                                                                                                                                 |         |
| 5.0          |                  | END OF BORING AT 5.0 FEET.                                                                                        |                          |                          |                                                         |                        |                                 |                                                                                                                                                                                                                                                                                 |         |
| 10           |                  |                                                                                                                   |                          |                          |                                                         |                        |                                 |                                                                                                                                                                                                                                                                                 |         |
| 15           |                  |                                                                                                                   |                          |                          |                                                         |                        |                                 |                                                                                                                                                                                                                                                                                 |         |
| 20           |                  |                                                                                                                   |                          |                          |                                                         |                        |                                 |                                                                                                                                                                                                                                                                                 |         |

|                                                                                                                                                                     |                                                                                                                                                                                                                                                                                                                                                                                                                       |
|---------------------------------------------------------------------------------------------------------------------------------------------------------------------|-----------------------------------------------------------------------------------------------------------------------------------------------------------------------------------------------------------------------------------------------------------------------------------------------------------------------------------------------------------------------------------------------------------------------|
| <p><b>GROUNDWATER &amp; BACKFILL INFORMATION</b></p> <p><input type="checkbox"/> DURING BORING: DEPTH (FT) Note 3</p> <p><b>BACKFILL METHOD:</b> Auger Cuttings</p> | <p><b>NOTES:</b></p> <ol style="list-style-type: none"> <li>The indicated stratification lines are approximate. The in-situ transitions between materials may be gradual.</li> <li>The colors depicted on the symbolic profile are solely for visualization purposes and do not necessarily represent the in-situ colors encountered.</li> <li>Groundwater levels were not measured during blind drilling.</li> </ol> |
|---------------------------------------------------------------------------------------------------------------------------------------------------------------------|-----------------------------------------------------------------------------------------------------------------------------------------------------------------------------------------------------------------------------------------------------------------------------------------------------------------------------------------------------------------------------------------------------------------------|

4/22/22 3:51:25 PM



# BORING B 2

PAGE 1 OF 1

BORING DEPTH: 9.5 FEET

**PROJECT NAME:** Hurstbourne Apartments Development

**PROJECT NUMBER:** 088601.00

**CLIENT:** Kennedy International, Inc

**PROJECT LOCATION:** Louisville, Kentucky

**DATE STARTED:** 3/14/22

**COMPLETED:** 3/14/22

**BORING METHOD:** Hollow-stem Augers

**DRILLER:** JK (Strata)

**RIG NO.:** 7822DT

**LOGGED BY:** JWJ

**CHECKED BY:** AEB

| DEPTH (FEET) | SYMBOLIC PROFILE | PROFILE DESCRIPTION                                | SAMPLE TYPE/NO. INTERVAL | RECOVERY LENGTH (INCHES) | SPT BLOWS PER SIX INCHES | HAMMER EFFICIENCY: 60%<br>DATE:<br>N <sub>60</sub> -- O | DRY DENSITY (pcf) -- ■ | MOISTURE & ATTERBERG LIMITS (%) | ▼ HAND PENE.<br>■ TORVANE SHEAR<br>○ UNC. COMP.<br>□ VANE SHEAR (PK)<br>× VANE SHEAR (REM)<br>◇ TRIAXIAL (UU) SHEAR<br>STRENGTH (KSF) 1 2 3 4 | REMARKS                    |
|--------------|------------------|----------------------------------------------------|--------------------------|--------------------------|--------------------------|---------------------------------------------------------|------------------------|---------------------------------|-----------------------------------------------------------------------------------------------------------------------------------------------|----------------------------|
|              |                  |                                                    |                          |                          |                          |                                                         | 90 100 110 120         | PL MC LL                        |                                                                                                                                               |                            |
| 0            |                  | 8 inches of TOPSOIL                                |                          |                          |                          |                                                         |                        |                                 |                                                                                                                                               |                            |
| 0.7          |                  |                                                    |                          |                          |                          |                                                         |                        |                                 |                                                                                                                                               |                            |
|              |                  | LEAN CLAY- Occasional Roots- Brown- Very Soft (CL) | SB1                      | 18                       | 1<br>1<br>1              | 2                                                       |                        | 25                              | ▼                                                                                                                                             |                            |
| 3.5          |                  |                                                    |                          |                          |                          |                                                         |                        |                                 |                                                                                                                                               |                            |
|              |                  | FAT CLAY- Brown and Red- Medium (CH)               | SB2                      | 14                       | 1<br>2<br>4              | 6                                                       |                        | 24                              | ▼                                                                                                                                             |                            |
| 5            |                  |                                                    |                          |                          |                          |                                                         |                        |                                 |                                                                                                                                               |                            |
|              |                  | FAT CLAY- Brown and Red- Medium (CH)               | SB3                      | 12                       | 2<br>2<br>4              | 6                                                       |                        | 23                              | ▼                                                                                                                                             |                            |
| 8.5          |                  |                                                    |                          |                          |                          |                                                         |                        |                                 |                                                                                                                                               |                            |
|              |                  | FAT CLAY- Brown and Red- Stiff (CH)                | SB4                      | 12                       | 4<br>8                   | 58+                                                     |                        | 31                              | ▼                                                                                                                                             |                            |
| 9.5          |                  |                                                    |                          |                          | 50/0"                    |                                                         |                        |                                 |                                                                                                                                               |                            |
| 10           |                  | END OF BORING AT 9.5 FEET.                         |                          |                          |                          |                                                         |                        |                                 |                                                                                                                                               | Auger refusal at 9.5 feet. |
| 15           |                  |                                                    |                          |                          |                          |                                                         |                        |                                 |                                                                                                                                               |                            |
| 20           |                  |                                                    |                          |                          |                          |                                                         |                        |                                 |                                                                                                                                               |                            |

|                                               |                                                                                                                                                                                                                                                                                                                                                                                                           |
|-----------------------------------------------|-----------------------------------------------------------------------------------------------------------------------------------------------------------------------------------------------------------------------------------------------------------------------------------------------------------------------------------------------------------------------------------------------------------|
| <b>GROUNDWATER &amp; BACKFILL INFORMATION</b> | <b>NOTES:</b> 1. The indicated stratification lines are approximate. The in-situ transitions between materials may be gradual.<br>2. The colors depicted on the symbolic profile are solely for visualization purposes and do not necessarily represent the in-situ colors encountered.<br>3. No hammer efficiency data was available, and the graphic output illustrates the field measured blow counts. |
| GROUNDWATER WAS NOT ENCOUNTERED               |                                                                                                                                                                                                                                                                                                                                                                                                           |
| <b>BACKFILL METHOD:</b> Auger Cuttings        |                                                                                                                                                                                                                                                                                                                                                                                                           |

4/22/22 3:51:26 PM



# BORING B 3

PAGE 1 OF 1

BORING DEPTH: 6.3 FEET

**PROJECT NAME:** Hurstbourne Apartments Development

**PROJECT NUMBER:** 088601.00

**CLIENT:** Kennedy International, Inc

**PROJECT LOCATION:** Louisville, Kentucky

**DATE STARTED:** 3/14/22

**COMPLETED:** 3/14/22

**BORING METHOD:** Hollow-stem Augers

**DRILLER:** JK (Strata)

**RIG NO.:** 7822DT

**LOGGED BY:** JWJ

**CHECKED BY:** AEB

| DEPTH (FEET)               | SYMBOLIC PROFILE | PROFILE DESCRIPTION                                        | SAMPLE TYPE/NO. INTERVAL | RECOVERY LENGTH (INCHES) | SPT BLOWS PER SIX INCHES | HAMMER EFFICIENCY: 60%<br>DATE:<br>N <sub>60</sub> -- O | DRY DENSITY (pcf) -- ■ | MOISTURE & ATTERBERG LIMITS (%) | ▼ HAND PENE.<br>■ TORVANE SHEAR<br>○ UNC. COMP.<br>□ VANE SHEAR (PK)<br>× VANE SHEAR (REM)<br>◆ TRIAXIAL (UU) SHEAR<br>STRENGTH (KSF) 1 2 3 4 | REMARKS                                                   |
|----------------------------|------------------|------------------------------------------------------------|--------------------------|--------------------------|--------------------------|---------------------------------------------------------|------------------------|---------------------------------|-----------------------------------------------------------------------------------------------------------------------------------------------|-----------------------------------------------------------|
|                            |                  |                                                            |                          |                          |                          |                                                         | 90 100 110 120         | PL MC LL                        |                                                                                                                                               |                                                           |
| 0                          |                  | 7 inches of TOPSOIL                                        |                          |                          |                          |                                                         |                        |                                 |                                                                                                                                               |                                                           |
| 0.6                        |                  |                                                            | SB1                      | 17                       | 0                        | 3                                                       |                        | 26, 35                          | ▼                                                                                                                                             | Sample SB1:<br>Atterberg<br>LL = 35<br>PL = 20<br>PI = 15 |
| 3.5                        |                  | LEAN CLAY- Occasional Roots- Brown- Very Soft to Soft (CL) |                          |                          | 1                        |                                                         |                        |                                 |                                                                                                                                               |                                                           |
| 5                          |                  | FAT CLAY- Brown and Red- Stiff (CH)                        | SB2                      | 14                       | 2                        | 9                                                       | 26                     | ▼                               |                                                                                                                                               |                                                           |
| 6.0                        |                  |                                                            | SB3                      | 2                        | 5                        | 50+                                                     |                        |                                 |                                                                                                                                               |                                                           |
| 6.3                        |                  | Highly to Completely Weathered SANDSTONE- Gray             |                          |                          |                          |                                                         |                        |                                 |                                                                                                                                               | Auger refusal at 6.3 feet.                                |
| END OF BORING AT 6.3 FEET. |                  |                                                            |                          |                          |                          |                                                         |                        |                                 |                                                                                                                                               |                                                           |

|                                               |                                                                                                                                                                                                                                                                                                                                                                                                           |
|-----------------------------------------------|-----------------------------------------------------------------------------------------------------------------------------------------------------------------------------------------------------------------------------------------------------------------------------------------------------------------------------------------------------------------------------------------------------------|
| <b>GROUNDWATER &amp; BACKFILL INFORMATION</b> | <b>NOTES:</b> 1. The indicated stratification lines are approximate. The in-situ transitions between materials may be gradual.<br>2. The colors depicted on the symbolic profile are solely for visualization purposes and do not necessarily represent the in-situ colors encountered.<br>3. No hammer efficiency data was available, and the graphic output illustrates the field measured blow counts. |
| GROUNDWATER WAS NOT ENCOUNTERED               |                                                                                                                                                                                                                                                                                                                                                                                                           |
| <b>BACKFILL METHOD:</b> Auger Cuttings        |                                                                                                                                                                                                                                                                                                                                                                                                           |

4/22/22 3:51:26 PM



# BORING B 4

PAGE 1 OF 1

BORING DEPTH: 7.6 FEET

**PROJECT NAME:** Hurstbourne Apartments Development

**PROJECT NUMBER:** 088601.00

**CLIENT:** Kennedy International, Inc

**PROJECT LOCATION:** Louisville, Kentucky

**DATE STARTED:** 3/14/22

**COMPLETED:** 3/14/22

**BORING METHOD:** Hollow-stem Augers

**DRILLER:** JK (Strata)

**RIG NO.:** 7822DT

**LOGGED BY:** JWJ

**CHECKED BY:** AEB

| DEPTH (FEET) | SYMBOLIC PROFILE | PROFILE DESCRIPTION                                                          | SAMPLE TYPE/NO. INTERVAL | RECOVERY LENGTH (INCHES) | SPT BLOWS PER SIX INCHES | HAMMER EFFICIENCY: 60%<br>DATE:<br>N <sub>60</sub> -- O | DRY DENSITY (pcf) -- ■ |     | MOISTURE & ATTERBERG LIMITS (%)<br>PL MC LL | ▼ HAND PENE.<br>■ TORVANE SHEAR<br>○ UNC. COMP.<br>□ VANE SHEAR (PK)<br>× VANE SHEAR (REM)<br>◆ TRIAXIAL (UU) SHEAR<br>STRENGTH (KSF) 1 2 3 4 | REMARKS                    |
|--------------|------------------|------------------------------------------------------------------------------|--------------------------|--------------------------|--------------------------|---------------------------------------------------------|------------------------|-----|---------------------------------------------|-----------------------------------------------------------------------------------------------------------------------------------------------|----------------------------|
|              |                  |                                                                              |                          |                          |                          |                                                         | 90                     | 100 |                                             |                                                                                                                                               |                            |
| 0            |                  | 6 inches of TOPSOIL                                                          |                          |                          |                          |                                                         |                        |     |                                             |                                                                                                                                               |                            |
| 0.5          |                  |                                                                              |                          |                          |                          |                                                         |                        |     |                                             |                                                                                                                                               |                            |
| 3.5          |                  | LEAN CLAY- Brown- Very Soft (CL)                                             | SB1                      | 15                       | 0<br>0<br>0              |                                                         |                        |     | 26                                          | ▼                                                                                                                                             |                            |
| 5            |                  | FAT CLAY- Brown and Red- Medium to Very Stiff (CH)                           | SB2                      | 18                       | 3<br>3<br>3              | 6                                                       |                        |     | 23                                          | ▼                                                                                                                                             |                            |
| 7.5          |                  |                                                                              | SB3                      | 15                       | 3<br>4<br>9              | 13                                                      |                        |     | 23                                          | ▼                                                                                                                                             |                            |
| 7.6          |                  | Highly to Completely Weathered SANDSTONE- Gray<br>END OF BORING AT 7.6 FEET. | SB4                      | 0.1                      | 50/0"                    | 50+                                                     |                        |     |                                             | ▼                                                                                                                                             | Auger refusal at 7.6 feet. |

|                                               |                                                                                                                                                                                                                                                                                                                                                                                                           |
|-----------------------------------------------|-----------------------------------------------------------------------------------------------------------------------------------------------------------------------------------------------------------------------------------------------------------------------------------------------------------------------------------------------------------------------------------------------------------|
| <b>GROUNDWATER &amp; BACKFILL INFORMATION</b> | <b>NOTES:</b> 1. The indicated stratification lines are approximate. The in-situ transitions between materials may be gradual.<br>2. The colors depicted on the symbolic profile are solely for visualization purposes and do not necessarily represent the in-situ colors encountered.<br>3. No hammer efficiency data was available, and the graphic output illustrates the field measured blow counts. |
| GROUNDWATER WAS NOT ENCOUNTERED               |                                                                                                                                                                                                                                                                                                                                                                                                           |
| <b>BACKFILL METHOD:</b> Auger Cuttings        |                                                                                                                                                                                                                                                                                                                                                                                                           |

4/22/22 3:51:27 PM



# BORING B 5

PAGE 1 OF 1

BORING DEPTH: 7.2 FEET

**PROJECT NAME:** Hurstbourne Apartments Development

**PROJECT NUMBER:** 088601.00

**CLIENT:** Kennedy International, Inc

**PROJECT LOCATION:** Louisville, Kentucky

**DATE STARTED:** 3/14/22

**COMPLETED:** 3/14/22

**BORING METHOD:** Hollow-stem Augers

**DRILLER:** JK (Strata)

**RIG NO.:** 7822DT

**LOGGED BY:** JWJ

**CHECKED BY:** AEB

| DEPTH (FEET)               | SYMBOLIC PROFILE | PROFILE DESCRIPTION                                                   | SAMPLE TYPE/NO. INTERVAL | RECOVERY LENGTH (INCHES) | SPT BLOWS PER SIX INCHES | HAMMER EFFICIENCY: 60%<br>DATE:<br>N <sub>60</sub> -- O | DRY DENSITY (pcf) -- ■ |             | MOISTURE & ATTERBERG LIMITS (%)<br>PL MC LL | ▼ HAND PENE.<br>■ TORVANE SHEAR<br>○ UNC. COMP.<br>□ VANE SHEAR (PK)<br>× VANE SHEAR (REM)<br>◇ TRIAXIAL (UU) SHEAR<br>STRENGTH (KSF) | REMARKS                    |
|----------------------------|------------------|-----------------------------------------------------------------------|--------------------------|--------------------------|--------------------------|---------------------------------------------------------|------------------------|-------------|---------------------------------------------|---------------------------------------------------------------------------------------------------------------------------------------|----------------------------|
|                            |                  |                                                                       |                          |                          |                          |                                                         | 90                     | 100 110 120 |                                             |                                                                                                                                       |                            |
| 0                          |                  | 7 inches of TOPSOIL                                                   |                          |                          |                          |                                                         |                        |             |                                             |                                                                                                                                       |                            |
| 0.6                        |                  | LEAN CLAY- Brown- Medium (CL)                                         |                          |                          |                          |                                                         |                        |             |                                             |                                                                                                                                       |                            |
| 1.5                        |                  |                                                                       | SB1                      | 18                       | 2<br>2<br>3              | 5                                                       |                        | 26          |                                             |                                                                                                                                       |                            |
|                            |                  | FAT CLAY- Frequent Rock Fragments- Brown and Red- Medium to Hard (CH) |                          |                          |                          |                                                         |                        |             |                                             |                                                                                                                                       |                            |
| 5                          |                  |                                                                       | SB2                      | 15                       | 2<br>3<br>5              | 8                                                       |                        | 25          |                                             |                                                                                                                                       |                            |
|                            |                  |                                                                       |                          |                          |                          |                                                         |                        |             |                                             |                                                                                                                                       |                            |
| 7.2                        |                  |                                                                       | SB3                      | 12                       | 3<br>4<br>50/2"          | 54+                                                     |                        | 27          |                                             |                                                                                                                                       |                            |
| END OF BORING AT 7.2 FEET. |                  |                                                                       |                          |                          |                          |                                                         |                        |             |                                             |                                                                                                                                       | Auger refusal at 7.2 feet. |

|                                               |                                                                                                                                                                                                                                                                                                                                                                                                           |
|-----------------------------------------------|-----------------------------------------------------------------------------------------------------------------------------------------------------------------------------------------------------------------------------------------------------------------------------------------------------------------------------------------------------------------------------------------------------------|
| <b>GROUNDWATER &amp; BACKFILL INFORMATION</b> | <b>NOTES:</b> 1. The indicated stratification lines are approximate. The in-situ transitions between materials may be gradual.<br>2. The colors depicted on the symbolic profile are solely for visualization purposes and do not necessarily represent the in-situ colors encountered.<br>3. No hammer efficiency data was available, and the graphic output illustrates the field measured blow counts. |
| GROUNDWATER WAS NOT ENCOUNTERED               |                                                                                                                                                                                                                                                                                                                                                                                                           |
| <b>BACKFILL METHOD:</b> Auger Cuttings        |                                                                                                                                                                                                                                                                                                                                                                                                           |

4/22/22 3:51:28 PM



# BORING B 6

PAGE 1 OF 1

BORING DEPTH: 6.2 FEET

**PROJECT NAME:** Hurstbourne Apartments Development

**PROJECT NUMBER:** 088601.00

**CLIENT:** Kennedy International, Inc

**PROJECT LOCATION:** Louisville, Kentucky

**DATE STARTED:** 3/14/22

**COMPLETED:** 3/14/22

**BORING METHOD:** Hollow-stem Augers

**DRILLER:** JK (Strata)

**RIG NO.:** 7822DT

**LOGGED BY:** JWJ

**CHECKED BY:** AEB

| DEPTH (FEET) | SYMBOLIC PROFILE | PROFILE DESCRIPTION                            | SAMPLE TYPE/NO. INTERVAL | RECOVERY LENGTH (INCHES) | SPT BLOWS PER SIX INCHES | HAMMER EFFICIENCY: 60%<br>DATE:<br>N <sub>60</sub> -- O | DRY DENSITY (pcf) -- ■ |     | MOISTURE & ATTERBERG LIMITS (%) |     |    | REMARKS                    |
|--------------|------------------|------------------------------------------------|--------------------------|--------------------------|--------------------------|---------------------------------------------------------|------------------------|-----|---------------------------------|-----|----|----------------------------|
|              |                  |                                                |                          |                          |                          |                                                         | 90                     | 100 | 110                             | 120 | PL |                            |
| 0            |                  | 7 inches of TOPSOIL                            |                          |                          |                          |                                                         |                        |     |                                 |     |    |                            |
| 0.6          |                  | LEAN CLAY- Frequent Roots- Brown-Medium (CL)   |                          |                          |                          |                                                         |                        |     |                                 |     |    |                            |
| 1.5          |                  |                                                | SB1                      | 15                       | 1<br>2<br>3              | 5                                                       |                        |     | 24                              |     |    |                            |
|              |                  | FAT CLAY- Brown and Red- Medium to Stiff (CH)  |                          |                          |                          |                                                         |                        |     |                                 |     |    |                            |
| 5            |                  |                                                | SB2                      | 15                       | 3<br>3<br>6              | 9                                                       |                        |     | 30                              |     |    |                            |
| 6.0          |                  |                                                |                          |                          |                          |                                                         |                        |     |                                 |     |    |                            |
| 6.2          |                  | Highly to Completely Weathered SANDSTONE- Gray | SB3                      | 2                        | 50/2"                    | 50+                                                     |                        |     |                                 |     |    | Auger refusal at 6.2 feet. |
|              |                  | END OF BORING AT 6.2 FEET.                     |                          |                          |                          |                                                         |                        |     |                                 |     |    |                            |

|                                               |                                                                                                                                                                                                                                                                                                                                                                                                                   |
|-----------------------------------------------|-------------------------------------------------------------------------------------------------------------------------------------------------------------------------------------------------------------------------------------------------------------------------------------------------------------------------------------------------------------------------------------------------------------------|
| <b>GROUNDWATER &amp; BACKFILL INFORMATION</b> | <p>NOTES: 1. The indicated stratification lines are approximate. The in-situ transitions between materials may be gradual.</p> <p>2. The colors depicted on the symbolic profile are solely for visualization purposes and do not necessarily represent the in-situ colors encountered.</p> <p>3. No hammer efficiency data was available, and the graphic output illustrates the field measured blow counts.</p> |
| GROUNDWATER WAS NOT ENCOUNTERED               |                                                                                                                                                                                                                                                                                                                                                                                                                   |
| <b>BACKFILL METHOD:</b> Auger Cuttings        |                                                                                                                                                                                                                                                                                                                                                                                                                   |



4/22/22 3:51:30 PM



# BORING B 7

PAGE 1 OF 1

BORING DEPTH: 6.8 FEET

**PROJECT NAME:** Hurstbourne Apartments Development

**PROJECT NUMBER:** 088601.00

**CLIENT:** Kennedy International, Inc

**PROJECT LOCATION:** Louisville, Kentucky

**DATE STARTED:** 3/16/22

**COMPLETED:** 3/16/22

**BORING METHOD:** Hollow-stem Augers

**DRILLER:** JK (Strata)

**RIG NO.:** 7822DT

**LOGGED BY:** JWJ

**CHECKED BY:** AEB

| DEPTH (FEET) | SYMBOLIC PROFILE | PROFILE DESCRIPTION                                                               | SAMPLE TYPE/NO. INTERVAL | RECOVERY LENGTH (INCHES) | SPT BLOWS PER SIX INCHES | HAMMER EFFICIENCY: 60%<br>DATE:<br>N <sub>60</sub> -- O | DRY DENSITY (pcf) -- ■ |     |         | MOISTURE & ATTERBERG LIMITS (%)<br>PL MC LL | ▼ HAND PENE.<br>■ TORVANE SHEAR<br>○ UNC. COMP.<br>□ VANE SHEAR (PK)<br>× VANE SHEAR (REM)<br>◆ TRIAXIAL (UU) SHEAR<br>STRENGTH (KSF) 1 2 3 4 | REMARKS                    |
|--------------|------------------|-----------------------------------------------------------------------------------|--------------------------|--------------------------|--------------------------|---------------------------------------------------------|------------------------|-----|---------|---------------------------------------------|-----------------------------------------------------------------------------------------------------------------------------------------------|----------------------------|
|              |                  |                                                                                   |                          |                          |                          |                                                         | 90                     | 100 | 110 120 |                                             |                                                                                                                                               |                            |
| 0            |                  | 6 inches of TOPSOIL                                                               |                          |                          |                          |                                                         |                        |     |         |                                             |                                                                                                                                               |                            |
| 0.5          |                  | LEAN CLAY- Brown- Very Soft to Soft (CL)                                          |                          |                          |                          |                                                         |                        |     |         |                                             |                                                                                                                                               |                            |
| 1.5          |                  | FAT CLAY- Occasional Rock Fragments- Brown and Gray- Very Soft to Very Stiff (CH) | SB1                      | 18                       | 0                        | 2                                                       |                        |     | 24      |                                             |                                                                                                                                               |                            |
|              |                  |                                                                                   |                          |                          | 1                        | 1                                                       |                        |     |         |                                             |                                                                                                                                               |                            |
|              |                  |                                                                                   |                          | SB2                      | 18                       | 11                                                      | 10                     |     |         | 30                                          |                                                                                                                                               |                            |
| 5            |                  |                                                                                   |                          |                          | 5                        |                                                         |                        |     |         |                                             |                                                                                                                                               |                            |
| 6.8          |                  | END OF BORING AT 6.8 FEET.                                                        | SB3                      | 7                        | 2                        | 50+                                                     |                        |     | 33      |                                             |                                                                                                                                               | Auger refusal at 6.8 feet. |
|              |                  |                                                                                   |                          |                          |                          |                                                         |                        |     |         |                                             |                                                                                                                                               |                            |
| 10           |                  |                                                                                   |                          |                          |                          |                                                         |                        |     |         |                                             |                                                                                                                                               |                            |
| 15           |                  |                                                                                   |                          |                          |                          |                                                         |                        |     |         |                                             |                                                                                                                                               |                            |
| 20           |                  |                                                                                   |                          |                          |                          |                                                         |                        |     |         |                                             |                                                                                                                                               |                            |

|                                               |                                                                                                                                                                                                                                                                                                                                                                                                           |
|-----------------------------------------------|-----------------------------------------------------------------------------------------------------------------------------------------------------------------------------------------------------------------------------------------------------------------------------------------------------------------------------------------------------------------------------------------------------------|
| <b>GROUNDWATER &amp; BACKFILL INFORMATION</b> | <b>NOTES:</b> 1. The indicated stratification lines are approximate. The in-situ transitions between materials may be gradual.<br>2. The colors depicted on the symbolic profile are solely for visualization purposes and do not necessarily represent the in-situ colors encountered.<br>3. No hammer efficiency data was available, and the graphic output illustrates the field measured blow counts. |
| GROUNDWATER WAS NOT ENCOUNTERED               |                                                                                                                                                                                                                                                                                                                                                                                                           |
| <b>BACKFILL METHOD:</b> Auger Cuttings        |                                                                                                                                                                                                                                                                                                                                                                                                           |

4/22/22 3:51:30 PM



# BORING B 8

PAGE 1 OF 1

BORING DEPTH: 7.4 FEET

**PROJECT NAME:** Hurstbourne Apartments Development

**PROJECT NUMBER:** 088601.00

**CLIENT:** Kennedy International, Inc

**PROJECT LOCATION:** Louisville, Kentucky

**DATE STARTED:** 3/16/22

**COMPLETED:** 3/16/22

**BORING METHOD:** Hollow-stem Augers

**DRILLER:** JK (Strata)

**RIG NO.:** 7822DT

**LOGGED BY:** JWJ

**CHECKED BY:** AEB

| DEPTH (FEET) | SYMBOLIC PROFILE | PROFILE DESCRIPTION                           | SAMPLE TYPE/NO. INTERVAL | RECOVERY LENGTH (INCHES) | SPT BLOWS PER SIX INCHES | HAMMER EFFICIENCY: 60%<br>DATE:<br>N <sub>60</sub> -- O | DRY DENSITY (pcf) -- ■ |             | MOISTURE & ATTERBERG LIMITS (%)<br>PL MC LL | ▼ HAND PENE.<br>■ TORVANE SHEAR<br>○ UNC. COMP.<br>□ VANE SHEAR (PK)<br>× VANE SHEAR (REM)<br>◇ TRIAXIAL (UU) SHEAR<br>STRENGTH (KSF) 1 2 3 4 | REMARKS                    |
|--------------|------------------|-----------------------------------------------|--------------------------|--------------------------|--------------------------|---------------------------------------------------------|------------------------|-------------|---------------------------------------------|-----------------------------------------------------------------------------------------------------------------------------------------------|----------------------------|
|              |                  |                                               |                          |                          |                          |                                                         | 90                     | 100 110 120 |                                             |                                                                                                                                               |                            |
| 0            |                  | 7 inches of TOPSOIL                           |                          |                          |                          |                                                         |                        |             |                                             |                                                                                                                                               |                            |
| 0.6          |                  |                                               |                          |                          |                          |                                                         |                        |             |                                             |                                                                                                                                               |                            |
| 3.0          |                  | LEAN CLAY- Brown- Very Soft to Soft (CL)      | SB1                      | 18                       | 0<br>1                   | 2                                                       |                        |             | 26                                          | ▼                                                                                                                                             |                            |
| 5.0          |                  | FAT CLAY- Brown and Red- Medium to Stiff (CH) | SB2                      | 18                       | 2<br>3<br>4              | 7                                                       |                        |             | 24                                          | ▼                                                                                                                                             |                            |
| 7.4          |                  |                                               | SB3                      | 15                       | 3<br>8                   | 58+                                                     |                        |             | 29                                          | ▼                                                                                                                                             |                            |
|              |                  | END OF BORING AT 7.4 FEET.                    |                          |                          |                          |                                                         |                        |             |                                             |                                                                                                                                               | Auger refusal at 7.4 feet. |

|                                               |
|-----------------------------------------------|
| <b>GROUNDWATER &amp; BACKFILL INFORMATION</b> |
| GROUNDWATER WAS NOT ENCOUNTERED               |
| <b>BACKFILL METHOD:</b> Auger Cuttings        |

NOTES: 1. The indicated stratification lines are approximate. The in-situ transitions between materials may be gradual.  
 2. The colors depicted on the symbolic profile are solely for visualization purposes and do not necessarily represent the in-situ colors encountered.  
 3. No hammer efficiency data was available, and the graphic output illustrates the field measured blow counts.

4/22/22 3:51:31 PM



# BORING B 9

PAGE 1 OF 1

BORING DEPTH: 4.8 FEET

**PROJECT NAME:** Hurstbourne Apartments Development

**PROJECT NUMBER:** 088601.00

**CLIENT:** Kennedy International, Inc

**PROJECT LOCATION:** Louisville, Kentucky

**DATE STARTED:** 3/16/22

**COMPLETED:** 3/16/22

**BORING METHOD:** Hollow-stem Augers

**DRILLER:** JK (Strata)

**RIG NO.:** 7822DT

**LOGGED BY:** JWJ

**CHECKED BY:** AEB

| DEPTH (FEET) | SYMBOLIC PROFILE | PROFILE DESCRIPTION                              | SAMPLE TYPE/NO. INTERVAL | RECOVERY LENGTH (INCHES) | SPT BLOWS PER SIX INCHES | HAMMER EFFICIENCY: 60%<br>DATE:<br>N <sub>60</sub> -- O | DRY DENSITY (pcf) -- ■ |     | MOISTURE & ATTERBERG LIMITS (%) |     |    | REMARKS                    |
|--------------|------------------|--------------------------------------------------|--------------------------|--------------------------|--------------------------|---------------------------------------------------------|------------------------|-----|---------------------------------|-----|----|----------------------------|
|              |                  |                                                  |                          |                          |                          |                                                         | 90                     | 100 | 110                             | 120 | PL |                            |
| 0            |                  | 8 inches of TOPSOIL                              |                          |                          |                          |                                                         |                        |     |                                 |     |    |                            |
| 0.7          |                  | LEAN CLAY- Frequent Roots- Brown-Soft (CL)       |                          |                          |                          |                                                         |                        |     |                                 |     |    |                            |
| 1.5          |                  | FAT CLAY- Brown and Red- Soft to Very Stiff (CH) | SB1                      | 15                       | 0<br>2                   | 4                                                       |                        |     | 24                              |     |    |                            |
| 4.8          |                  |                                                  | SB2                      | 14                       | 3<br>5<br>50/3"          | 55+                                                     |                        |     | 30                              |     |    |                            |
| 5            |                  | END OF BORING AT 4.8 FEET.                       |                          |                          |                          |                                                         |                        |     |                                 |     |    | Auger refusal at 4.8 feet. |

|                                               |
|-----------------------------------------------|
| <b>GROUNDWATER &amp; BACKFILL INFORMATION</b> |
| GROUNDWATER WAS NOT ENCOUNTERED               |
| <b>BACKFILL METHOD:</b> Auger Cuttings        |

NOTES: 1. The indicated stratification lines are approximate. The in-situ transitions between materials may be gradual.  
 2. The colors depicted on the symbolic profile are solely for visualization purposes and do not necessarily represent the in-situ colors encountered.  
 3. No hammer efficiency data was available, and the graphic output illustrates the field measured blow counts.

4/22/22 3:51:32 PM



# BORING B10

PAGE 1 OF 1

BORING DEPTH: 1.8 FEET

**PROJECT NAME:** Hurstbourne Apartments Development

**PROJECT NUMBER:** 088601.00

**CLIENT:** Kennedy International, Inc

**PROJECT LOCATION:** Louisville, Kentucky

**DATE STARTED:** 3/16/22

**COMPLETED:** 3/16/22

**BORING METHOD:** Hollow-stem Augers

**DRILLER:** JK (Strata)

**RIG NO.:** 7822DT

**LOGGED BY:** JWJ

**CHECKED BY:** AEB

| DEPTH (FEET) | SYMBOLIC PROFILE | PROFILE DESCRIPTION                           | SAMPLE TYPE/NO. INTERVAL | RECOVERY LENGTH (INCHES) | SPT BLOWS PER SIX INCHES | HAMMER EFFICIENCY: 60%<br>DATE:<br>N <sub>60</sub> -- O | DRY DENSITY (pcf) -- ■ |     | MOISTURE & ATTERBERG LIMITS (%) |     | REMARKS                    |
|--------------|------------------|-----------------------------------------------|--------------------------|--------------------------|--------------------------|---------------------------------------------------------|------------------------|-----|---------------------------------|-----|----------------------------|
|              |                  |                                               |                          |                          |                          |                                                         | 90                     | 100 | 110                             | 120 |                            |
| 0            |                  | 8 inches of TOPSOIL                           |                          |                          |                          |                                                         |                        |     |                                 |     |                            |
| 0.7          |                  | LEAN CLAY- Brown- Soft to Medium (CL)         |                          |                          |                          |                                                         |                        |     |                                 |     |                            |
| 1.3          |                  | FAT CLAY- Brown and Gray- Soft to Medium (CH) | SB1                      | 5                        | 3<br>50/3"               |                                                         |                        |     |                                 | 24  |                            |
| 1.8          |                  | END OF BORING AT 1.8 FEET.                    |                          |                          |                          |                                                         |                        |     |                                 | 50+ | Auger refusal at 1.8 feet. |
| 5            |                  |                                               |                          |                          |                          |                                                         |                        |     |                                 |     |                            |
| 10           |                  |                                               |                          |                          |                          |                                                         |                        |     |                                 |     |                            |
| 15           |                  |                                               |                          |                          |                          |                                                         |                        |     |                                 |     |                            |
| 20           |                  |                                               |                          |                          |                          |                                                         |                        |     |                                 |     |                            |

|                                               |
|-----------------------------------------------|
| <b>GROUNDWATER &amp; BACKFILL INFORMATION</b> |
| GROUNDWATER WAS NOT ENCOUNTERED               |
| <b>BACKFILL METHOD:</b> Auger Cuttings        |

NOTES: 1. The indicated stratification lines are approximate. The in-situ transitions between materials may be gradual.  
 2. The colors depicted on the symbolic profile are solely for visualization purposes and do not necessarily represent the in-situ colors encountered.  
 3. No hammer efficiency data was available, and the graphic output illustrates the field measured blow counts.

4/22/22 3:51:33 PM



# BORING B11

PAGE 1 OF 1

BORING DEPTH: 1.4 FEET

**PROJECT NAME:** Hurstbourne Apartments Development

**PROJECT NUMBER:** 088601.00

**CLIENT:** Kennedy International, Inc

**PROJECT LOCATION:** Louisville, Kentucky

**DATE STARTED:** 3/16/22

**COMPLETED:** 3/16/22

**BORING METHOD:** Hollow-stem Augers

**DRILLER:** JK (Strata)

**RIG NO.:** 7822DT

**LOGGED BY:** JWJ

**CHECKED BY:** AEB

| DEPTH (FEET) | SYMBOLIC PROFILE | PROFILE DESCRIPTION                                    | SAMPLE TYPE/NO. INTERVAL | RECOVERY LENGTH (INCHES) | SPT BLOWS PER SIX INCHES | HAMMER EFFICIENCY: 60%<br>DATE:<br>N <sub>60</sub> -- O | DRY DENSITY (pcf) -- ■ |     | MOISTURE & ATTERBERG LIMITS (%) |     | REMARKS                    |
|--------------|------------------|--------------------------------------------------------|--------------------------|--------------------------|--------------------------|---------------------------------------------------------|------------------------|-----|---------------------------------|-----|----------------------------|
|              |                  |                                                        |                          |                          |                          |                                                         | 90                     | 100 | 110                             | 120 |                            |
| 0            |                  | 6 inches of TOPSOIL                                    |                          |                          |                          |                                                         |                        |     |                                 |     |                            |
| 0.5          |                  | LEAN CLAY- Occasional Roots- Brown-Soft to Medium (CL) |                          |                          |                          |                                                         |                        |     |                                 |     |                            |
| 1.4          |                  | END OF BORING AT 1.4 FEET.                             | SB1                      | 4                        | 50/5"                    |                                                         | 50+                    |     | 29                              |     | Auger refusal at 1.4 feet. |
| 5            |                  |                                                        |                          |                          |                          |                                                         |                        |     |                                 |     |                            |
| 10           |                  |                                                        |                          |                          |                          |                                                         |                        |     |                                 |     |                            |
| 15           |                  |                                                        |                          |                          |                          |                                                         |                        |     |                                 |     |                            |
| 20           |                  |                                                        |                          |                          |                          |                                                         |                        |     |                                 |     |                            |

**GROUNDWATER & BACKFILL INFORMATION**

GROUNDWATER WAS NOT ENCOUNTERED

**BACKFILL METHOD:** Auger Cuttings

**NOTES:** 1. The indicated stratification lines are approximate. The in-situ transitions between materials may be gradual.  
 2. The colors depicted on the symbolic profile are solely for visualization purposes and do not necessarily represent the in-situ colors encountered.  
 3. No hammer efficiency data was available, and the graphic output illustrates the field measured blow counts.

4/22/22 3:51:34 PM



# BORING B12

PAGE 1 OF 1

BORING DEPTH: 15 FEET

**PROJECT NAME:** Hurstbourne Apartments Development

**PROJECT NUMBER:** 088601.00

**CLIENT:** Kennedy International, Inc

**PROJECT LOCATION:** Louisville, Kentucky

**DATE STARTED:** 3/16/22

**COMPLETED:** 3/16/22

**BORING METHOD:** Hollow-stem Augers

**DRILLER:** JK (Strata)

**RIG NO.:** 7822DT

**LOGGED BY:** JWJ

**CHECKED BY:** AEB

| DEPTH (FEET) | SYMBOLIC PROFILE | PROFILE DESCRIPTION                                | SAMPLE TYPE/NO. INTERVAL | RECOVERY LENGTH (INCHES) | SPT BLOWS PER SIX INCHES | HAMMER EFFICIENCY: 60%<br>DATE:<br>N <sub>60</sub> -- O | DRY DENSITY (pcf) -- ■ |     | MOISTURE & ATTERBERG LIMITS (%) |     | ▼ HAND PENE.<br>■ TORVANE SHEAR<br>○ UNC. COMP.<br>□ VANE SHEAR (PK)<br>× VANE SHEAR (REM)<br>◆ TRIAXIAL (UU) SHEAR<br>STRENGTH (KSF) | REMARKS                                                       |
|--------------|------------------|----------------------------------------------------|--------------------------|--------------------------|--------------------------|---------------------------------------------------------|------------------------|-----|---------------------------------|-----|---------------------------------------------------------------------------------------------------------------------------------------|---------------------------------------------------------------|
|              |                  |                                                    |                          |                          |                          |                                                         | 90                     | 100 | 110                             | 120 |                                                                                                                                       |                                                               |
| 0            |                  | 6 inches of TOPSOIL                                |                          |                          |                          |                                                         |                        |     |                                 |     |                                                                                                                                       |                                                               |
| 0.5          |                  |                                                    | SB1                      | 16                       | 1<br>1<br>1              | 2                                                       |                        |     | 30                              |     | ▼                                                                                                                                     |                                                               |
| 5            |                  | LEAN CLAY- Brown- Very Soft to Soft (CL)           | SB2                      | 18                       | 1<br>2<br>2              | 4                                                       |                        |     | 24                              |     | ▼                                                                                                                                     |                                                               |
| 6.0          |                  |                                                    | SB3                      | 15                       | 1<br>1<br>1              | 2                                                       |                        |     | 24                              |     | ▼                                                                                                                                     |                                                               |
| 10           |                  | LEAN CLAY- Brown and Red- Very Soft to Medium (CL) | SB4                      | 0                        | 1<br>1<br>1              | 2                                                       |                        |     | 30                              |     | ▼                                                                                                                                     |                                                               |
| 15.0         |                  | END OF BORING AT 15.0 FEET.                        | SB5                      | 3                        | 1<br>3<br>3              | 6                                                       |                        |     | 28                              |     | ▼                                                                                                                                     |                                                               |
| 15           |                  |                                                    |                          |                          |                          |                                                         |                        |     |                                 |     |                                                                                                                                       | Auger deflection from vertical. Boring terminated at 15 feet. |

|                                               |
|-----------------------------------------------|
| <b>GROUNDWATER &amp; BACKFILL INFORMATION</b> |
| GROUNDWATER WAS NOT ENCOUNTERED               |
| <b>BACKFILL METHOD:</b> Auger Cuttings        |

NOTES: 1. The indicated stratification lines are approximate. The in-situ transitions between materials may be gradual.  
 2. The colors depicted on the symbolic profile are solely for visualization purposes and do not necessarily represent the in-situ colors encountered.  
 3. No hammer efficiency data was available, and the graphic output illustrates the field measured blow counts.



4/22/22 3:51:35 PM



# BORING B12A

PAGE 1 OF 1

BORING DEPTH: 15.8 FEET

**PROJECT NAME:** Hurstbourne Apartments Development

**PROJECT NUMBER:** 088601.00

**CLIENT:** Kennedy International, Inc

**PROJECT LOCATION:** Louisville, Kentucky

**DATE STARTED:** 3/16/22

**COMPLETED:** 3/16/22

**BORING METHOD:** Hollow-stem Augers

**DRILLER:** JK (Strata)

**RIG NO.:** 7822DT

**LOGGED BY:** JWJ

**CHECKED BY:** AEB

| DEPTH (FEET) | SYMBOLIC PROFILE | PROFILE DESCRIPTION                                              | SAMPLE TYPE/NO. INTERVAL | RECOVERY LENGTH (INCHES) | HAMMER EFFICIENCY: 60%<br>DATE:<br>N <sub>60</sub> -- O | DRY DENSITY (pcf) -- ■ | MOISTURE & ATTERBERG LIMITS (%) | ▲ HAND PENE.<br>■ TORVANE SHEAR<br>● UNC. COMP.<br>□ VANE SHEAR (PK)<br>× VANE SHEAR (REM)<br>⊕ TRIAXIAL (UU) SHEAR<br>STRENGTH (KSF) | REMARKS                     |
|--------------|------------------|------------------------------------------------------------------|--------------------------|--------------------------|---------------------------------------------------------|------------------------|---------------------------------|---------------------------------------------------------------------------------------------------------------------------------------|-----------------------------|
|              |                  |                                                                  |                          |                          |                                                         | 90 100 110 120         | PL MC LL                        |                                                                                                                                       |                             |
| 0            |                  |                                                                  |                          |                          |                                                         |                        |                                 |                                                                                                                                       |                             |
| 5            |                  |                                                                  |                          |                          |                                                         |                        |                                 |                                                                                                                                       |                             |
| 10           |                  |                                                                  |                          |                          |                                                         |                        |                                 |                                                                                                                                       |                             |
| 15           |                  |                                                                  |                          |                          |                                                         |                        |                                 |                                                                                                                                       |                             |
| 15.8         |                  | Blind Drilled to 15.8 Feet. See Boring B12 for Soil Information. |                          |                          |                                                         |                        |                                 |                                                                                                                                       |                             |
|              |                  | END OF BORING AT 15.8 FEET.                                      |                          |                          |                                                         |                        |                                 |                                                                                                                                       | Auger refusal at 15.8 feet. |
| 20           |                  |                                                                  |                          |                          |                                                         |                        |                                 |                                                                                                                                       |                             |

| GROUNDWATER & BACKFILL INFORMATION |                      |
|------------------------------------|----------------------|
| ▽ DURING BORING:                   | DEPTH (FT)<br>Note 3 |
| BACKFILL METHOD:                   | Note 4               |

**NOTES:**

- The indicated stratification lines are approximate. The in-situ transitions between materials may be gradual.
- The colors depicted on the symbolic profile are solely for visualization purposes and do not necessarily represent the in-situ colors encountered.
- Groundwater levels were not measured during blind drilling.
- The borehole was not filled to the surface after backfilling with the auger cuttings generated from drilling activities. An additional 15 bags (0.5 cubic foot each) of pea gravel were used which was unable to backfill the boring. A void space was observed at approximately 8 to 9 feet below grade by lowering a portable camera into the borehole. Traffic cones were placed at the surface at this location, and John Auble with ARCO Senior Living Multi-Family was notified by email and attempted phone call on March 18, 2022 to discuss filling the void space and advise those using the property avoid this area.

4/22/22 3:51:36 PM



# BORING B13

PAGE 1 OF 1

BORING DEPTH: 4.6 FEET

**PROJECT NAME:** Hurstbourne Apartments Development

**PROJECT NUMBER:** 088601.00

**CLIENT:** Kennedy International, Inc

**PROJECT LOCATION:** Louisville, Kentucky

**DATE STARTED:** 3/17/22

**COMPLETED:** 3/17/22

**BORING METHOD:** Hollow-stem Augers

**DRILLER:** JK (Strata)

**RIG NO.:** 7822DT

**LOGGED BY:** JWJ

**CHECKED BY:** AEB

| DEPTH (FEET) | SYMBOLIC PROFILE | PROFILE DESCRIPTION                                             | SAMPLE TYPE/NO. INTERVAL | RECOVERY LENGTH (INCHES) | SPT BLOWS PER SIX INCHES | HAMMER EFFICIENCY: 60%<br>DATE:<br>N <sub>60</sub> -- O | DRY DENSITY (pcf) -- ■ | MOISTURE & ATTERBERG LIMITS (%)<br>PL MC LL | <ul style="list-style-type: none"> <li>▼ HAND PENE.</li> <li>■ TORVANE SHEAR</li> <li>○ UNC. COMP.</li> <li>□ VANE SHEAR (PK)</li> <li>× VANE SHEAR (REM)</li> <li>◇ TRIAXIAL (UU) SHEAR</li> <li>STRENGTH (KSF)</li> </ul> | REMARKS                    |
|--------------|------------------|-----------------------------------------------------------------|--------------------------|--------------------------|--------------------------|---------------------------------------------------------|------------------------|---------------------------------------------|-----------------------------------------------------------------------------------------------------------------------------------------------------------------------------------------------------------------------------|----------------------------|
|              |                  |                                                                 |                          |                          |                          |                                                         | 90 100 110 120         |                                             |                                                                                                                                                                                                                             |                            |
| 0            |                  | 7 inches of TOPSOIL                                             |                          |                          |                          |                                                         |                        |                                             |                                                                                                                                                                                                                             |                            |
| 0.6          |                  |                                                                 |                          |                          |                          |                                                         |                        |                                             |                                                                                                                                                                                                                             |                            |
|              |                  | LEAN CLAY- Occasional Roots- Brown- Medium to Stiff (CL)        | SB1                      | 8                        | 2<br>2<br>3              | 5                                                       |                        | 21                                          | ▼                                                                                                                                                                                                                           |                            |
| 3.5          |                  |                                                                 |                          |                          |                          |                                                         |                        |                                             |                                                                                                                                                                                                                             |                            |
|              |                  | LEAN CLAY- Occasional Rock Fragments- Brown and Red- Stiff (CL) | SB2                      | 11                       | 3<br>5<br>50/1"          | 55+                                                     |                        | 24                                          | ▼                                                                                                                                                                                                                           |                            |
| 4.6          |                  |                                                                 |                          |                          |                          |                                                         |                        |                                             |                                                                                                                                                                                                                             |                            |
| 5            |                  | END OF BORING AT 4.6 FEET.                                      |                          |                          |                          |                                                         |                        |                                             |                                                                                                                                                                                                                             | Auger refusal at 4.6 feet. |

|                                               |                                                                                                                                                                                                                                                                                                                                                                                                                   |
|-----------------------------------------------|-------------------------------------------------------------------------------------------------------------------------------------------------------------------------------------------------------------------------------------------------------------------------------------------------------------------------------------------------------------------------------------------------------------------|
| <b>GROUNDWATER &amp; BACKFILL INFORMATION</b> | <p>NOTES: 1. The indicated stratification lines are approximate. The in-situ transitions between materials may be gradual.</p> <p>2. The colors depicted on the symbolic profile are solely for visualization purposes and do not necessarily represent the in-situ colors encountered.</p> <p>3. No hammer efficiency data was available, and the graphic output illustrates the field measured blow counts.</p> |
| GROUNDWATER WAS NOT ENCOUNTERED               |                                                                                                                                                                                                                                                                                                                                                                                                                   |
| <b>BACKFILL METHOD:</b> Auger Cuttings        |                                                                                                                                                                                                                                                                                                                                                                                                                   |

4/22/22 3:51:37 PM



# BORING B14

PAGE 1 OF 1

BORING DEPTH: 6.8 FEET

**PROJECT NAME:** Hurstbourne Apartments Development

**PROJECT NUMBER:** 088601.00

**CLIENT:** Kennedy International, Inc

**PROJECT LOCATION:** Louisville, Kentucky

**DATE STARTED:** 3/17/22

**COMPLETED:** 3/17/22

**BORING METHOD:** Hollow-stem Augers

**DRILLER:** JK (Strata)

**RIG NO.:** 7822DT

**LOGGED BY:** JWJ

**CHECKED BY:** AEB

| DEPTH (FEET) | SYMBOLIC PROFILE | PROFILE DESCRIPTION                                      | SAMPLE TYPE/NO. INTERVAL | RECOVERY LENGTH (INCHES) | SPT BLOWS PER SIX INCHES | HAMMER EFFICIENCY: 60%<br>DATE:<br>N <sub>60</sub> -- O | DRY DENSITY (pcf) -- ■ |     |     | MOISTURE & ATTERBERG LIMITS (%) |    |    | REMARKS                    |
|--------------|------------------|----------------------------------------------------------|--------------------------|--------------------------|--------------------------|---------------------------------------------------------|------------------------|-----|-----|---------------------------------|----|----|----------------------------|
|              |                  |                                                          |                          |                          |                          |                                                         | 90                     | 100 | 110 | 120                             | PL | MC |                            |
| 0            |                  | 6 inches of TOPSOIL                                      |                          |                          |                          |                                                         |                        |     |     |                                 |    |    |                            |
| 0.5          |                  |                                                          |                          |                          |                          |                                                         |                        |     |     |                                 |    |    |                            |
| 3.5          |                  | LEAN CLAY- Brown- Soft to Stiff (CL)                     | SB1                      | 11                       | 1<br>2<br>2              | 4                                                       |                        |     |     | 25                              |    |    |                            |
| 5            |                  | LEAN CLAY with Sand- Brown and Red- Medium to Stiff (CL) | SB2                      | 15                       | 3<br>4<br>6              | 10                                                      |                        |     |     | 25                              |    |    |                            |
| 6.8          |                  | END OF BORING AT 6.8 FEET.                               | SB3                      | 6                        | 3<br>50/3"               | 50+                                                     |                        |     |     | 26                              |    |    | Auger refusal at 6.8 feet. |

**GROUNDWATER & BACKFILL INFORMATION**

GROUNDWATER WAS NOT ENCOUNTERED

**BACKFILL METHOD:** Auger Cuttings

**NOTES:** 1. The indicated stratification lines are approximate. The in-situ transitions between materials may be gradual.  
 2. The colors depicted on the symbolic profile are solely for visualization purposes and do not necessarily represent the in-situ colors encountered.  
 3. No hammer efficiency data was available, and the graphic output illustrates the field measured blow counts.

4/22/22 3:51:38 PM



# BORING B15

PAGE 1 OF 1

BORING DEPTH: 6.7 FEET

**PROJECT NAME:** Hurstbourne Apartments Development

**PROJECT NUMBER:** 088601.00

**CLIENT:** Kennedy International, Inc

**PROJECT LOCATION:** Louisville, Kentucky

**DATE STARTED:** 3/17/22

**COMPLETED:** 3/17/22

**BORING METHOD:** Hollow-stem Augers

**DRILLER:** JK (Strata)

**RIG NO.:** 7822DT

**LOGGED BY:** JWJ

**CHECKED BY:** AEB

| DEPTH (FEET) | SYMBOLIC PROFILE | PROFILE DESCRIPTION                                                                 | SAMPLE TYPE/NO. INTERVAL | RECOVERY LENGTH (INCHES) | SPT BLOWS PER SIX INCHES | HAMMER EFFICIENCY: 60%<br>DATE:<br>N <sub>60</sub> -- O | DRY DENSITY (pcf) -- ■ |             | MOISTURE & ATTERBERG LIMITS (%)<br>PL MC LL | ▼ HAND PENE.<br>■ TORVANE SHEAR<br>○ UNC. COMP.<br>□ VANE SHEAR (PK)<br>× VANE SHEAR (REM)<br>◆ TRIAXIAL (UU) SHEAR<br>STRENGTH (KSF) 1 2 3 4 | REMARKS                    |
|--------------|------------------|-------------------------------------------------------------------------------------|--------------------------|--------------------------|--------------------------|---------------------------------------------------------|------------------------|-------------|---------------------------------------------|-----------------------------------------------------------------------------------------------------------------------------------------------|----------------------------|
|              |                  |                                                                                     |                          |                          |                          |                                                         | 90                     | 100 110 120 |                                             |                                                                                                                                               |                            |
| 0            |                  | 6 inches of TOPSOIL                                                                 |                          |                          |                          |                                                         |                        |             |                                             |                                                                                                                                               |                            |
| 0.5          |                  |                                                                                     |                          |                          |                          |                                                         |                        |             |                                             |                                                                                                                                               |                            |
| 3.5          |                  | LEAN CLAY- Frequent Roots- Brown-Medium (CL)                                        | SB1                      | 12                       | 1<br>2<br>4              | 6                                                       |                        |             | 25                                          | ▼                                                                                                                                             |                            |
| 5            |                  | LEAN CLAY with Sand- Occasional Rock Fragments- Brown and Gray-Medium to Stiff (CL) | SB2                      | 14                       | 3<br>5<br>7              | 12                                                      |                        |             | 25                                          | ▼                                                                                                                                             |                            |
| 6.7          |                  | END OF BORING AT 6.7 FEET.                                                          | SB3                      |                          | 5<br>50/5"               | 50+                                                     |                        |             | 27                                          | ▼                                                                                                                                             | Auger refusal at 5.8 feet. |

|                                               |                                                                                                                                                                                                                                                                                                                                                                                                           |
|-----------------------------------------------|-----------------------------------------------------------------------------------------------------------------------------------------------------------------------------------------------------------------------------------------------------------------------------------------------------------------------------------------------------------------------------------------------------------|
| <b>GROUNDWATER &amp; BACKFILL INFORMATION</b> | <b>NOTES:</b> 1. The indicated stratification lines are approximate. The in-situ transitions between materials may be gradual.<br>2. The colors depicted on the symbolic profile are solely for visualization purposes and do not necessarily represent the in-situ colors encountered.<br>3. No hammer efficiency data was available, and the graphic output illustrates the field measured blow counts. |
| GROUNDWATER WAS NOT ENCOUNTERED               |                                                                                                                                                                                                                                                                                                                                                                                                           |
| <b>BACKFILL METHOD:</b> Auger Cuttings        |                                                                                                                                                                                                                                                                                                                                                                                                           |

4/22/22 3:51:39 PM



# BORING B16

PAGE 1 OF 1

BORING DEPTH: 10.3 FEET

**PROJECT NAME:** Hurstbourne Apartments Development

**PROJECT NUMBER:** 088601.00

**CLIENT:** Kennedy International, Inc

**PROJECT LOCATION:** Louisville, Kentucky

**DATE STARTED:** 3/14/22

**COMPLETED:** 3/14/22

**BORING METHOD:** Hollow-stem Augers

**DRILLER:** JK (Strata)

**RIG NO.:** 7822DT

**LOGGED BY:** JWJ

**CHECKED BY:** AEB

| DEPTH (FEET) | SYMBOLIC PROFILE | PROFILE DESCRIPTION                               | SAMPLE TYPE/NO. INTERVAL | RECOVERY LENGTH (INCHES) | SPT BLOWS PER SIX INCHES | HAMMER EFFICIENCY: 60%<br>DATE:<br>N <sub>60</sub> -- O | DRY DENSITY (pcf) -- ■ |     | MOISTURE & ATTERBERG LIMITS (%) |     | ▲ HAND PENE.<br>■ TORVANE SHEAR<br>● UNC. COMP.<br>□ VANE SHEAR (PK)<br>× VANE SHEAR (REM)<br>◆ TRIAXIAL (UU) SHEAR<br>STRENGTH (KSF) | REMARKS                                                   |
|--------------|------------------|---------------------------------------------------|--------------------------|--------------------------|--------------------------|---------------------------------------------------------|------------------------|-----|---------------------------------|-----|---------------------------------------------------------------------------------------------------------------------------------------|-----------------------------------------------------------|
|              |                  |                                                   |                          |                          |                          |                                                         | 90                     | 100 | 110                             | 120 |                                                                                                                                       |                                                           |
| 0            |                  | 8 inches of TOPSOIL                               |                          |                          |                          |                                                         |                        |     |                                 |     |                                                                                                                                       |                                                           |
| 0.7          |                  |                                                   | SB1                      | 13                       | 1<br>3<br>5              | 8                                                       |                        |     | 24                              |     |                                                                                                                                       |                                                           |
| 3.5          |                  |                                                   | SB2                      | 12                       | 4<br>6<br>8              | 14                                                      |                        |     | 26                              |     |                                                                                                                                       |                                                           |
| 5            |                  | FAT CLAY- Brown and Red- Stiff to Very Stiff (CH) | SB3                      | 15                       | 2<br>6<br>8              | 14                                                      |                        |     | 26<br>22                        | 55  |                                                                                                                                       | Sample SB3:<br>Atterberg<br>LL = 55<br>PL = 22<br>PI = 33 |
| 8.5          |                  |                                                   | SB4                      | 16                       | 3<br>5<br>7              | 12                                                      |                        |     | 28                              |     |                                                                                                                                       |                                                           |
| 10           |                  | END OF BORING AT 10.3 FEET.                       |                          |                          |                          |                                                         |                        |     |                                 |     |                                                                                                                                       | Auger refusal at 10.3 feet.                               |

|                                               |
|-----------------------------------------------|
| <b>GROUNDWATER &amp; BACKFILL INFORMATION</b> |
| GROUNDWATER WAS NOT ENCOUNTERED               |
| <b>BACKFILL METHOD:</b> Auger Cuttings        |

NOTES: 1. The indicated stratification lines are approximate. The in-situ transitions between materials may be gradual.  
 2. The colors depicted on the symbolic profile are solely for visualization purposes and do not necessarily represent the in-situ colors encountered.  
 3. No hammer efficiency data was available, and the graphic output illustrates the field measured blow counts.

4/22/22 3:51:40 PM



# BORING B17

PAGE 1 OF 1

BORING DEPTH: 5.9 FEET

**PROJECT NAME:** Hurstbourne Apartments Development

**PROJECT NUMBER:** 088601.00

**CLIENT:** Kennedy International, Inc

**PROJECT LOCATION:** Louisville, Kentucky

**DATE STARTED:** 3/17/22

**COMPLETED:** 3/17/22

**BORING METHOD:** Hollow-stem Augers

**DRILLER:** JK (Strata)

**RIG NO.:** 7822DT

**LOGGED BY:** JWJ

**CHECKED BY:** AEB

| DEPTH (FEET) | SYMBOLIC PROFILE | PROFILE DESCRIPTION                                                     | SAMPLE TYPE/NO. INTERVAL | RECOVERY LENGTH (INCHES) | SPT BLOWS PER SIX INCHES | HAMMER EFFICIENCY: 60%<br>DATE:<br>N <sub>60</sub> -- O | DRY DENSITY (pcf) -- ■ |     | MOISTURE & ATTERBERG LIMITS (%) |     | ▲ HAND PENE.<br>■ TORVANE SHEAR<br>○ UNC. COMP.<br>□ VANE SHEAR (PK)<br>× VANE SHEAR (REM)<br>◆ TRIAXIAL (UU) SHEAR<br>STRENGTH (KSF) | REMARKS |
|--------------|------------------|-------------------------------------------------------------------------|--------------------------|--------------------------|--------------------------|---------------------------------------------------------|------------------------|-----|---------------------------------|-----|---------------------------------------------------------------------------------------------------------------------------------------|---------|
|              |                  |                                                                         |                          |                          |                          |                                                         | 90                     | 100 | 110                             | 120 |                                                                                                                                       |         |
| 0            |                  | 5 inches of TOPSOIL                                                     |                          |                          |                          |                                                         |                        |     |                                 |     |                                                                                                                                       |         |
| 0.4          |                  |                                                                         |                          |                          |                          |                                                         |                        |     |                                 |     |                                                                                                                                       |         |
| 3.5          |                  | LEAN CLAY- Occasional Roots- Brown- Very Soft (CL)                      | SB1                      | 12                       | 0                        |                                                         |                        |     |                                 | 26  |                                                                                                                                       |         |
| 5            |                  | FAT CLAY with Sand- Frequent Rock Fragments- Brown and Red- Medium (CH) | SB2                      | 9                        | 2                        |                                                         |                        |     |                                 | 27  |                                                                                                                                       |         |
| 5.9          |                  | END OF BORING AT 5.9 FEET.                                              | SB3                      |                          | 50/1"                    | 50+                                                     |                        |     |                                 | 31  |                                                                                                                                       |         |

Auger refusal at 5.8 feet.

|                                               |
|-----------------------------------------------|
| <b>GROUNDWATER &amp; BACKFILL INFORMATION</b> |
| GROUNDWATER WAS NOT ENCOUNTERED               |
| <b>BACKFILL METHOD:</b> Auger Cuttings        |

NOTES: 1. The indicated stratification lines are approximate. The in-situ transitions between materials may be gradual.  
 2. The colors depicted on the symbolic profile are solely for visualization purposes and do not necessarily represent the in-situ colors encountered.  
 3. No hammer efficiency data was available, and the graphic output illustrates the field measured blow counts.



4/22/22 3:51:41 PM



# BORING B18

PAGE 1 OF 1

BORING DEPTH: 13.4 FEET

**PROJECT NAME:** Hurstbourne Apartments Development

**PROJECT NUMBER:** 088601.00

**CLIENT:** Kennedy International, Inc

**PROJECT LOCATION:** Louisville, Kentucky

**DATE STARTED:** 3/17/22

**COMPLETED:** 3/17/22

**BORING METHOD:** Hollow-stem Augers

**DRILLER:** JK (Strata)

**RIG NO.:** 7822DT

**LOGGED BY:** JWJ

**CHECKED BY:** AEB

| DEPTH (FEET) | SYMBOLIC PROFILE | PROFILE DESCRIPTION                                                                         | SAMPLE TYPE/NO. INTERVAL | RECOVERY LENGTH (INCHES) | SPT BLOWS PER SIX INCHES | HAMMER EFFICIENCY: 60%<br>DATE:<br>N <sub>60</sub> -- O | DRY DENSITY (pcf) -- ■ |     | MOISTURE & ATTERBERG LIMITS (%) |     | ▲ HAND PENE.<br>■ TORVANE SHEAR<br>○ UNC. COMP.<br>□ VANE SHEAR (PK)<br>× VANE SHEAR (REM)<br>◇ TRIAXIAL (UU) SHEAR<br>STRENGTH (KSF) 1 2 3 4 | REMARKS                     |
|--------------|------------------|---------------------------------------------------------------------------------------------|--------------------------|--------------------------|--------------------------|---------------------------------------------------------|------------------------|-----|---------------------------------|-----|-----------------------------------------------------------------------------------------------------------------------------------------------|-----------------------------|
|              |                  |                                                                                             |                          |                          |                          |                                                         | 90                     | 100 | 110                             | 120 |                                                                                                                                               |                             |
| 0            |                  | 7 inches of TOPSOIL                                                                         |                          |                          |                          |                                                         |                        |     |                                 |     |                                                                                                                                               |                             |
| 0.6          |                  |                                                                                             |                          |                          |                          |                                                         |                        |     |                                 |     |                                                                                                                                               |                             |
|              |                  | LEAN CLAY- Brown- Medium (CL)                                                               | SB1                      | 10                       | 1<br>3<br>4              | 7                                                       |                        |     | 24                              |     |                                                                                                                                               |                             |
|              |                  |                                                                                             |                          |                          |                          |                                                         |                        |     |                                 |     |                                                                                                                                               |                             |
|              |                  |                                                                                             | SB2                      | 15                       | 3<br>3<br>4              | 7                                                       |                        |     | 22                              |     |                                                                                                                                               |                             |
|              |                  |                                                                                             |                          |                          |                          |                                                         |                        |     |                                 |     |                                                                                                                                               |                             |
|              |                  |                                                                                             | SB3                      | 18                       | 3<br>4<br>7              | 11                                                      |                        |     | 23                              |     |                                                                                                                                               |                             |
|              |                  |                                                                                             |                          |                          |                          |                                                         |                        |     |                                 |     |                                                                                                                                               |                             |
|              |                  | LEAN to FAT CLAY with Sand- Frequent Rock Fragments- Brown and Red- Medium to Stiff (CL/CH) | SB4                      | 8                        | 3<br>5<br>7              | 12                                                      |                        |     | 21                              |     |                                                                                                                                               |                             |
|              |                  |                                                                                             |                          |                          |                          |                                                         |                        |     |                                 |     |                                                                                                                                               |                             |
|              |                  |                                                                                             | SB5                      |                          |                          | 50/1"                                                   |                        |     | 50+                             |     |                                                                                                                                               |                             |
|              |                  | Highly to Completely Weathered SANDSTONE- Brown                                             |                          |                          |                          |                                                         |                        |     |                                 |     |                                                                                                                                               | Auger refusal at 13.3 feet. |
|              |                  | END OF BORING AT 13.4 FEET.                                                                 |                          |                          |                          |                                                         |                        |     |                                 |     |                                                                                                                                               |                             |
| 13.3         |                  |                                                                                             |                          |                          |                          |                                                         |                        |     |                                 |     |                                                                                                                                               |                             |
| 13.4         |                  |                                                                                             |                          |                          |                          |                                                         |                        |     |                                 |     |                                                                                                                                               |                             |
| 15           |                  |                                                                                             |                          |                          |                          |                                                         |                        |     |                                 |     |                                                                                                                                               |                             |
| 20           |                  |                                                                                             |                          |                          |                          |                                                         |                        |     |                                 |     |                                                                                                                                               |                             |

|                                               |
|-----------------------------------------------|
| <b>GROUNDWATER &amp; BACKFILL INFORMATION</b> |
| GROUNDWATER WAS NOT ENCOUNTERED               |
| <b>BACKFILL METHOD:</b> Auger Cuttings        |

NOTES: 1. The indicated stratification lines are approximate. The in-situ transitions between materials may be gradual.  
 2. The colors depicted on the symbolic profile are solely for visualization purposes and do not necessarily represent the in-situ colors encountered.  
 3. No hammer efficiency data was available, and the graphic output illustrates the field measured blow counts.

4/22/22 3:51:42 PM



# BORING B19

PAGE 1 OF 1

BORING DEPTH: 3.3 FEET

**PROJECT NAME:** Hurstbourne Apartments Development

**PROJECT NUMBER:** 088601.00

**CLIENT:** Kennedy International, Inc

**PROJECT LOCATION:** Louisville, Kentucky

**DATE STARTED:** 3/17/22

**COMPLETED:** 3/17/22

**BORING METHOD:** Hollow-stem Augers

**DRILLER:** JK (Strata)

**RIG NO.:** 7822DT

**LOGGED BY:** JWJ

**CHECKED BY:** AEB

| DEPTH (FEET) | SYMBOLIC PROFILE | PROFILE DESCRIPTION                                     | SAMPLE TYPE/NO. INTERVAL | RECOVERY LENGTH (INCHES) | SPT BLOWS PER SIX INCHES | HAMMER EFFICIENCY: 60%<br>DATE:<br>N <sub>60</sub> -- O | DRY DENSITY (pcf) -- ■ | MOISTURE & ATTERBERG LIMITS (%)<br>PL MC LL | <input type="checkbox"/> HAND PENE.<br><input type="checkbox"/> TORVANE SHEAR<br><input type="checkbox"/> UNC. COMP.<br><input type="checkbox"/> VANE SHEAR (PK)<br><input type="checkbox"/> VANE SHEAR (REM)<br><input type="checkbox"/> TRIAXIAL (UU) SHEAR<br>STRENGTH (KSF) 1 2 3 4 | REMARKS                    |
|--------------|------------------|---------------------------------------------------------|--------------------------|--------------------------|--------------------------|---------------------------------------------------------|------------------------|---------------------------------------------|-----------------------------------------------------------------------------------------------------------------------------------------------------------------------------------------------------------------------------------------------------------------------------------------|----------------------------|
|              |                  |                                                         |                          |                          |                          |                                                         | 90 100 110 120         |                                             |                                                                                                                                                                                                                                                                                         |                            |
| 0            |                  | 6 inches of TOPSOIL                                     |                          |                          |                          |                                                         |                        |                                             |                                                                                                                                                                                                                                                                                         |                            |
| 0.5          |                  | LEAN CLAY- Occasional Roots- Brown- Soft to Medium (CL) | SB1                      | 8                        | 1<br>2<br>2              | 4                                                       |                        | 25                                          | <input checked="" type="checkbox"/>                                                                                                                                                                                                                                                     |                            |
| 3.1          |                  | Highly Weathered LIMESTONE- Highly Fractured- Gray      | SB2                      |                          | 50/3"                    | 50+                                                     |                        |                                             |                                                                                                                                                                                                                                                                                         |                            |
| 3.3          |                  | END OF BORING AT 3.3 FEET.                              |                          |                          |                          |                                                         |                        |                                             |                                                                                                                                                                                                                                                                                         | Auger refusal at 3.3 feet. |

|                                               |                                                                                                                                                                                                                                                                                                                                                                                                           |
|-----------------------------------------------|-----------------------------------------------------------------------------------------------------------------------------------------------------------------------------------------------------------------------------------------------------------------------------------------------------------------------------------------------------------------------------------------------------------|
| <b>GROUNDWATER &amp; BACKFILL INFORMATION</b> | <b>NOTES:</b> 1. The indicated stratification lines are approximate. The in-situ transitions between materials may be gradual.<br>2. The colors depicted on the symbolic profile are solely for visualization purposes and do not necessarily represent the in-situ colors encountered.<br>3. No hammer efficiency data was available, and the graphic output illustrates the field measured blow counts. |
| GROUNDWATER WAS NOT ENCOUNTERED               |                                                                                                                                                                                                                                                                                                                                                                                                           |
| <b>BACKFILL METHOD:</b> Auger Cuttings        |                                                                                                                                                                                                                                                                                                                                                                                                           |

4/22/22 3:51:43 PM



# BORING B20

PAGE 1 OF 1

BORING DEPTH: 8.7 FEET

**PROJECT NAME:** Hurstbourne Apartments Development

**PROJECT NUMBER:** 088601.00

**CLIENT:** Kennedy International, Inc

**PROJECT LOCATION:** Louisville, Kentucky

**DATE STARTED:** 3/17/22

**COMPLETED:** 3/17/22

**BORING METHOD:** Hollow-stem Augers

**DRILLER:** JK (Strata)

**RIG NO.:** 7822DT

**LOGGED BY:** JWJ

**CHECKED BY:** AEB

| DEPTH (FEET) | SYMBOLIC PROFILE | PROFILE DESCRIPTION                                      | SAMPLE TYPE/NO. INTERVAL | RECOVERY LENGTH (INCHES) | SPT BLOWS PER SIX INCHES | HAMMER EFFICIENCY: 60%<br>DATE:<br>N <sub>60</sub> -- O | DRY DENSITY (pcf) -- ■ |     |         | MOISTURE & ATTERBERG LIMITS (%)<br>PL MC LL | ▼ HAND PENE.<br>■ TORVANE SHEAR<br>○ UNC. COMP.<br>□ VANE SHEAR (PK)<br>× VANE SHEAR (REM)<br>◆ TRIAXIAL (UU) SHEAR<br>STRENGTH (KSF) | REMARKS                    |
|--------------|------------------|----------------------------------------------------------|--------------------------|--------------------------|--------------------------|---------------------------------------------------------|------------------------|-----|---------|---------------------------------------------|---------------------------------------------------------------------------------------------------------------------------------------|----------------------------|
|              |                  |                                                          |                          |                          |                          |                                                         | 90                     | 100 | 110 120 |                                             |                                                                                                                                       |                            |
| 0            |                  | 8 inches of TOPSOIL                                      |                          |                          |                          |                                                         |                        |     |         |                                             |                                                                                                                                       |                            |
| 0.7          |                  |                                                          |                          |                          |                          |                                                         |                        |     |         |                                             |                                                                                                                                       |                            |
| 3.5          |                  | LEAN CLAY- Frequent Roots- Brown- Very Soft to Soft (CL) | SB1                      | 8                        | 2                        |                                                         |                        |     | 26      |                                             |                                                                                                                                       |                            |
| 5            |                  | FAT CLAY- Brown and Red- Stiff (CH)                      | SB2                      | 11                       | 10                       |                                                         |                        |     | 23      |                                             |                                                                                                                                       |                            |
| 8.7          |                  |                                                          | SB3                      | 10                       | 11                       |                                                         |                        |     | 28      |                                             |                                                                                                                                       |                            |
| 8.7          |                  | END OF BORING AT 8.7 FEET.                               | SB4                      | 50/2"                    | 50+                      |                                                         |                        |     |         |                                             |                                                                                                                                       | Auger refusal at 8.7 feet. |

|                                               |                                                                                                                                                                                                                                                                                                                                                                                                           |
|-----------------------------------------------|-----------------------------------------------------------------------------------------------------------------------------------------------------------------------------------------------------------------------------------------------------------------------------------------------------------------------------------------------------------------------------------------------------------|
| <b>GROUNDWATER &amp; BACKFILL INFORMATION</b> | <b>NOTES:</b> 1. The indicated stratification lines are approximate. The in-situ transitions between materials may be gradual.<br>2. The colors depicted on the symbolic profile are solely for visualization purposes and do not necessarily represent the in-situ colors encountered.<br>3. No hammer efficiency data was available, and the graphic output illustrates the field measured blow counts. |
| GROUNDWATER WAS NOT ENCOUNTERED               |                                                                                                                                                                                                                                                                                                                                                                                                           |
| <b>BACKFILL METHOD:</b> Auger Cuttings        |                                                                                                                                                                                                                                                                                                                                                                                                           |

4/22/22 3:51:44 PM



# BORING B21

PAGE 1 OF 1

BORING DEPTH: 7.6 FEET

**PROJECT NAME:** Hurstbourne Apartments Development

**PROJECT NUMBER:** 088601.00

**CLIENT:** Kennedy International, Inc

**PROJECT LOCATION:** Louisville, Kentucky

**DATE STARTED:** 3/17/22

**COMPLETED:** 3/17/22

**BORING METHOD:** Hollow-stem Augers

**DRILLER:** JK (Strata)

**RIG NO.:** 7822DT

**LOGGED BY:** JWJ

**CHECKED BY:** AEB

| DEPTH (FEET) | SYMBOLIC PROFILE | PROFILE DESCRIPTION                                                            | SAMPLE TYPE/NO. INTERVAL | RECOVERY LENGTH (INCHES) | SPT BLOWS PER SIX INCHES | HAMMER EFFICIENCY: 60%<br>DATE:<br>N <sub>60</sub> -- O | DRY DENSITY (pcf) -- ■ | MOISTURE & ATTERBERG LIMITS (%)<br>PL MC LL | ▼ HAND PENE.<br>■ TORVANE SHEAR<br>○ UNC. COMP.<br>□ VANE SHEAR (PK)<br>× VANE SHEAR (REM)<br>◇ TRIAXIAL (UU) SHEAR<br>STRENGTH (KSF) 1 2 3 4 | REMARKS                    |
|--------------|------------------|--------------------------------------------------------------------------------|--------------------------|--------------------------|--------------------------|---------------------------------------------------------|------------------------|---------------------------------------------|-----------------------------------------------------------------------------------------------------------------------------------------------|----------------------------|
|              |                  |                                                                                |                          |                          |                          |                                                         | 90 100 110 120         |                                             |                                                                                                                                               |                            |
| 0            |                  | 8 inches of TOPSOIL                                                            |                          |                          |                          |                                                         |                        |                                             |                                                                                                                                               |                            |
| 0.7          |                  |                                                                                |                          |                          |                          |                                                         |                        |                                             |                                                                                                                                               |                            |
|              |                  | LEAN CLAY- Frequent Roots- Brown- Soft to Medium (CL)                          | SB1                      | 18                       | 1<br>2<br>2              | 4                                                       |                        | 24                                          | ▼                                                                                                                                             |                            |
| 3.5          |                  |                                                                                |                          |                          |                          |                                                         |                        |                                             |                                                                                                                                               |                            |
|              |                  | FAT CLAY- Brown and Red- Stiff (CH)                                            | SB2                      | 18                       | 3<br>4<br>7              | 11                                                      |                        | 26                                          | ▼                                                                                                                                             |                            |
| 5            |                  |                                                                                |                          |                          |                          |                                                         |                        |                                             |                                                                                                                                               |                            |
| 6.0          |                  |                                                                                |                          |                          |                          |                                                         |                        |                                             |                                                                                                                                               |                            |
|              |                  | LEAN CLAY with Sand- Occasional Rock Fragments- Brown- Soft to Very Stiff (CL) | SB3                      | 8                        | 3<br>5<br>16             | 21                                                      |                        | 52                                          | ▼                                                                                                                                             |                            |
| 7.6          |                  |                                                                                |                          |                          |                          |                                                         |                        |                                             |                                                                                                                                               |                            |
|              |                  | END OF BORING AT 7.6 FEET.                                                     |                          |                          |                          |                                                         |                        |                                             |                                                                                                                                               | Auger refusal at 7.6 feet. |
| 10           |                  |                                                                                |                          |                          |                          |                                                         |                        |                                             |                                                                                                                                               |                            |
| 15           |                  |                                                                                |                          |                          |                          |                                                         |                        |                                             |                                                                                                                                               |                            |
| 20           |                  |                                                                                |                          |                          |                          |                                                         |                        |                                             |                                                                                                                                               |                            |

|                                               |
|-----------------------------------------------|
| <b>GROUNDWATER &amp; BACKFILL INFORMATION</b> |
| GROUNDWATER WAS NOT ENCOUNTERED               |
| <b>BACKFILL METHOD:</b> Auger Cuttings        |

NOTES: 1. The indicated stratification lines are approximate. The in-situ transitions between materials may be gradual.  
 2. The colors depicted on the symbolic profile are solely for visualization purposes and do not necessarily represent the in-situ colors encountered.  
 3. No hammer efficiency data was available, and the graphic output illustrates the field measured blow counts.







4/22/22 3:51:46 PM



# BORING B23

PAGE 1 OF 1

BORING DEPTH: 7.4 FEET

**PROJECT NAME:** Hurstbourne Apartments Development

**PROJECT NUMBER:** 088601.00

**CLIENT:** Kennedy International, Inc

**PROJECT LOCATION:** Louisville, Kentucky

**DATE STARTED:** 3/17/22

**COMPLETED:** 3/17/22

**BORING METHOD:** Hollow-stem Augers

**DRILLER:** JK (Strata)

**RIG NO.:** 7822DT

**LOGGED BY:** JWJ

**CHECKED BY:** AEB

| DEPTH (FEET) | SYMBOLIC PROFILE | PROFILE DESCRIPTION                                                             | SAMPLE TYPE/NO. INTERVAL | RECOVERY LENGTH (INCHES) | SPT BLOWS PER SIX INCHES | HAMMER EFFICIENCY: 60%<br>DATE:<br>N <sub>60</sub> -- O | DRY DENSITY (pcf) -- ■ |     | MOISTURE & ATTERBERG LIMITS (%)<br>PL MC LL | ▼ HAND PENE.<br>■ TORVANE SHEAR<br>○ UNC. COMP.<br>□ VANE SHEAR (PK)<br>× VANE SHEAR (REM)<br>◆ TRIAXIAL (UU) SHEAR<br>STRENGTH (KSF) | REMARKS                                                   |
|--------------|------------------|---------------------------------------------------------------------------------|--------------------------|--------------------------|--------------------------|---------------------------------------------------------|------------------------|-----|---------------------------------------------|---------------------------------------------------------------------------------------------------------------------------------------|-----------------------------------------------------------|
|              |                  |                                                                                 |                          |                          |                          |                                                         | 90                     | 100 |                                             |                                                                                                                                       |                                                           |
| 0            |                  | 8 inches of TOPSOIL                                                             |                          |                          |                          |                                                         |                        |     |                                             |                                                                                                                                       |                                                           |
| 0.7          |                  | FAT CLAY- Occasional Roots- Brown and Red- Medium to Stiff (CH)                 | SB1                      | 10                       | 2<br>4<br>4              | 8                                                       |                        |     | 27<br>19                                    | 53                                                                                                                                    | Sample SB1:<br>Atterberg<br>LL = 53<br>PL = 19<br>PI = 34 |
| 3.5          |                  | Fine SAND with Gravel- Frequent Rock Fragments- Brown- Moist- Medium Dense (SP) | SB2                      | 12                       | 8<br>9<br>6              | 15                                                      |                        |     |                                             |                                                                                                                                       |                                                           |
| 7.0          |                  | Highly to Completely Weathered SANDSTONE- Brown                                 | SB3                      | 6                        | 4<br>5                   | 55+                                                     |                        |     |                                             |                                                                                                                                       |                                                           |
| 7.4          |                  | END OF BORING AT 7.4 FEET.                                                      |                          |                          |                          |                                                         |                        |     |                                             |                                                                                                                                       | Auger refusal at 7.4 feet.                                |

|                                               |
|-----------------------------------------------|
| <b>GROUNDWATER &amp; BACKFILL INFORMATION</b> |
| GROUNDWATER WAS NOT ENCOUNTERED               |
| <b>BACKFILL METHOD:</b> Auger Cuttings        |

NOTES: 1. The indicated stratification lines are approximate. The in-situ transitions between materials may be gradual.  
 2. The colors depicted on the symbolic profile are solely for visualization purposes and do not necessarily represent the in-situ colors encountered.  
 3. No hammer efficiency data was available, and the graphic output illustrates the field measured blow counts.

4/22/22 3:51:47 PM



# BORING B24

PAGE 1 OF 1

BORING DEPTH: 6.4 FEET

**PROJECT NAME:** Hurstbourne Apartments Development

**PROJECT NUMBER:** 088601.00

**CLIENT:** Kennedy International, Inc

**PROJECT LOCATION:** Louisville, Kentucky

**DATE STARTED:** 3/17/22

**COMPLETED:** 3/17/22

**BORING METHOD:** Hollow-stem Augers

**DRILLER:** JK (Strata)

**RIG NO.:** 7822DT

**LOGGED BY:** JWJ

**CHECKED BY:** AEB

| DEPTH (FEET) | SYMBOLIC PROFILE | PROFILE DESCRIPTION                                                             | SAMPLE TYPE/NO. INTERVAL | RECOVERY LENGTH (INCHES) | SPT BLOWS PER SIX INCHES | HAMMER EFFICIENCY: 60%<br>DATE:<br>N <sub>60</sub> -- O | DRY DENSITY (pcf) -- ■ | MOISTURE & ATTERBERG LIMITS (%)<br>PL MC LL | <ul style="list-style-type: none"> <li>▼ HAND PENE.</li> <li>■ TORVANE SHEAR</li> <li>○ UNC. COMP.</li> <li>□ VANE SHEAR (PK)</li> <li>× VANE SHEAR (REM)</li> <li>◇ TRIAXIAL (UU) SHEAR</li> <li>STRENGTH (KSF)</li> </ul> | REMARKS                    |
|--------------|------------------|---------------------------------------------------------------------------------|--------------------------|--------------------------|--------------------------|---------------------------------------------------------|------------------------|---------------------------------------------|-----------------------------------------------------------------------------------------------------------------------------------------------------------------------------------------------------------------------------|----------------------------|
|              |                  |                                                                                 |                          |                          |                          |                                                         | 90 100 110 120         |                                             |                                                                                                                                                                                                                             |                            |
| 0            |                  | 7 inches of TOPSOIL                                                             |                          |                          |                          |                                                         |                        |                                             |                                                                                                                                                                                                                             |                            |
| 0.6          |                  |                                                                                 |                          |                          |                          |                                                         |                        |                                             |                                                                                                                                                                                                                             |                            |
|              |                  | FAT CLAY- Brown and Red- Medium (CH)                                            | SB1                      | 8                        | 1<br>2<br>3              | 5                                                       |                        | 25                                          |                                                                                                                                                                                                                             |                            |
| 3.5          |                  |                                                                                 |                          |                          |                          |                                                         |                        |                                             |                                                                                                                                                                                                                             |                            |
|              |                  | Fine SAND with Gravel- Frequent Rock Fragments- Brown- Moist- Medium Dense (SP) | SB2                      | 6                        | 3<br>13<br>6             | 19                                                      |                        |                                             |                                                                                                                                                                                                                             |                            |
| 5            |                  |                                                                                 |                          |                          |                          |                                                         |                        |                                             |                                                                                                                                                                                                                             |                            |
| 6.0          |                  |                                                                                 |                          |                          |                          |                                                         |                        |                                             |                                                                                                                                                                                                                             |                            |
| 6.4          |                  | Highly to Completely Weathered SANDSTONE- Brown                                 | SB3                      |                          | 50/5"                    | 50+                                                     |                        |                                             |                                                                                                                                                                                                                             |                            |
| 6.4          |                  | END OF BORING AT 6.4 FEET.                                                      |                          |                          |                          |                                                         |                        |                                             |                                                                                                                                                                                                                             | Auger refusal at 6.4 feet. |

|                                               |                                                                                                                                                                                                                                                                                                                                                                                                                   |
|-----------------------------------------------|-------------------------------------------------------------------------------------------------------------------------------------------------------------------------------------------------------------------------------------------------------------------------------------------------------------------------------------------------------------------------------------------------------------------|
| <b>GROUNDWATER &amp; BACKFILL INFORMATION</b> | <p>NOTES: 1. The indicated stratification lines are approximate. The in-situ transitions between materials may be gradual.</p> <p>2. The colors depicted on the symbolic profile are solely for visualization purposes and do not necessarily represent the in-situ colors encountered.</p> <p>3. No hammer efficiency data was available, and the graphic output illustrates the field measured blow counts.</p> |
| GROUNDWATER WAS NOT ENCOUNTERED               |                                                                                                                                                                                                                                                                                                                                                                                                                   |
| <b>BACKFILL METHOD:</b> Auger Cuttings        |                                                                                                                                                                                                                                                                                                                                                                                                                   |

4/22/22 3:51:48 PM



# BORING B25

PAGE 1 OF 1

BORING DEPTH: 5.9 FEET

**PROJECT NAME:** Hurstbourne Apartments Development

**PROJECT NUMBER:** 088601.00

**CLIENT:** Kennedy International, Inc

**PROJECT LOCATION:** Louisville, Kentucky

**DATE STARTED:** 3/17/22

**COMPLETED:** 3/17/22

**BORING METHOD:** Hollow-stem Augers

**DRILLER:** JK (Strata)

**RIG NO.:** 7822DT

**LOGGED BY:** JWJ

**CHECKED BY:** AEB

| DEPTH (FEET) | SYMBOLIC PROFILE | PROFILE DESCRIPTION                                                             | SAMPLE TYPE/NO. INTERVAL | RECOVERY LENGTH (INCHES) | SPT BLOWS PER SIX INCHES | HAMMER EFFICIENCY: 60%<br>DATE:<br>N <sub>60</sub> -- O | DRY DENSITY (pcf) -- ■ | MOISTURE & ATTERBERG LIMITS (%) | REMARKS                    |
|--------------|------------------|---------------------------------------------------------------------------------|--------------------------|--------------------------|--------------------------|---------------------------------------------------------|------------------------|---------------------------------|----------------------------|
|              |                  |                                                                                 |                          |                          |                          |                                                         | 90 100 110 120         | PL MC LL                        |                            |
| 0            |                  | 7 inches of TOPSOIL                                                             |                          |                          |                          |                                                         |                        |                                 |                            |
| 0.6          |                  |                                                                                 |                          |                          |                          |                                                         |                        |                                 |                            |
|              |                  | LEAN CLAY- Brown- Stiff (CL)                                                    | SB1                      | 8                        | 0<br>1<br>3              | 4                                                       |                        | 24                              |                            |
| 3.5          |                  |                                                                                 |                          |                          |                          |                                                         |                        |                                 |                            |
|              |                  | Fine SAND with Gravel- Frequent Rock Fragments- Brown- Moist- Medium Dense (SP) | SB2                      | 10                       | 5<br>7<br>21             | 28                                                      |                        |                                 |                            |
| 5            |                  |                                                                                 |                          |                          |                          |                                                         |                        |                                 |                            |
| 5.9          |                  | END OF BORING AT 5.9 FEET.                                                      | SB3                      |                          | 50/0"                    | 50+                                                     |                        |                                 | Auger refusal at 5.9 feet. |

|                                               |
|-----------------------------------------------|
| <b>GROUNDWATER &amp; BACKFILL INFORMATION</b> |
| GROUNDWATER WAS NOT ENCOUNTERED               |
| <b>BACKFILL METHOD:</b> Auger Cuttings        |

NOTES: 1. The indicated stratification lines are approximate. The in-situ transitions between materials may be gradual.  
 2. The colors depicted on the symbolic profile are solely for visualization purposes and do not necessarily represent the in-situ colors encountered.  
 3. No hammer efficiency data was available, and the graphic output illustrates the field measured blow counts.



4/22/22 3:51:49 PM



# BORING B25A

PAGE 1 OF 1

BORING DEPTH: 3.7 FEET

**PROJECT NAME:** Hurstbourne Apartments Development

**PROJECT NUMBER:** 088601.00

**CLIENT:** Kennedy International, Inc

**PROJECT LOCATION:** Louisville, Kentucky

**DATE STARTED:** 3/17/22

**COMPLETED:** 3/17/22

**BORING METHOD:** Hollow-stem Augers

**DRILLER:** JK (Strata)

**RIG NO.:** 7822DT

**LOGGED BY:** JWJ

**CHECKED BY:** AEB

| DEPTH (FEET) | SYMBOLIC PROFILE | PROFILE DESCRIPTION                                                                                                | SAMPLE TYPE/NO. INTERVAL | RECOVERY LENGTH (INCHES) | HAMMER EFFICIENCY: 60%<br>DATE:<br>N <sub>60</sub> -- O | DRY DENSITY (pcf) -- ■ | MOISTURE & ATTERBERG LIMITS (%)<br>PL MC LL | <input type="checkbox"/> HAND PENE.<br><input type="checkbox"/> TORVANE SHEAR<br><input type="checkbox"/> UNC. COMP.<br><input type="checkbox"/> VANE SHEAR (PK)<br><input type="checkbox"/> VANE SHEAR (REM)<br><input type="checkbox"/> TRIAXIAL (UU) SHEAR<br>STRENGTH (KSF) | REMARKS |
|--------------|------------------|--------------------------------------------------------------------------------------------------------------------|--------------------------|--------------------------|---------------------------------------------------------|------------------------|---------------------------------------------|---------------------------------------------------------------------------------------------------------------------------------------------------------------------------------------------------------------------------------------------------------------------------------|---------|
|              |                  |                                                                                                                    |                          |                          |                                                         | 90 100 110 120         |                                             |                                                                                                                                                                                                                                                                                 |         |
| 0            |                  | Blind Drilled to 2 Feet. See Boring B25 for Soil Information.                                                      |                          |                          |                                                         |                        |                                             |                                                                                                                                                                                                                                                                                 |         |
| 2.0          |                  |                                                                                                                    |                          |                          |                                                         |                        |                                             |                                                                                                                                                                                                                                                                                 |         |
| 3.7          |                  | Shelby Tube Was Not Extruded to Preserve Sample for Potential Future Testing. See Boring B22 for Soil Information. | 3ST1                     | 18                       |                                                         |                        |                                             |                                                                                                                                                                                                                                                                                 |         |
| 5            |                  | END OF BORING AT 3.7 FEET.                                                                                         |                          |                          |                                                         |                        |                                             |                                                                                                                                                                                                                                                                                 |         |
| 10           |                  |                                                                                                                    |                          |                          |                                                         |                        |                                             |                                                                                                                                                                                                                                                                                 |         |
| 15           |                  |                                                                                                                    |                          |                          |                                                         |                        |                                             |                                                                                                                                                                                                                                                                                 |         |
| 20           |                  |                                                                                                                    |                          |                          |                                                         |                        |                                             |                                                                                                                                                                                                                                                                                 |         |

|                                                                                                                                                   |                                                                                                                                                                                                                                                                                                                                                                                                                       |
|---------------------------------------------------------------------------------------------------------------------------------------------------|-----------------------------------------------------------------------------------------------------------------------------------------------------------------------------------------------------------------------------------------------------------------------------------------------------------------------------------------------------------------------------------------------------------------------|
| <p><b>GROUNDWATER &amp; BACKFILL INFORMATION</b></p> <p><b>DURING BORING:</b> DEPTH (FT) Note 3</p> <p><b>BACKFILL METHOD:</b> Auger Cuttings</p> | <p><b>NOTES:</b></p> <ol style="list-style-type: none"> <li>The indicated stratification lines are approximate. The in-situ transitions between materials may be gradual.</li> <li>The colors depicted on the symbolic profile are solely for visualization purposes and do not necessarily represent the in-situ colors encountered.</li> <li>Groundwater levels were not measured during blind drilling.</li> </ol> |
|---------------------------------------------------------------------------------------------------------------------------------------------------|-----------------------------------------------------------------------------------------------------------------------------------------------------------------------------------------------------------------------------------------------------------------------------------------------------------------------------------------------------------------------------------------------------------------------|

4/22/22 3:51:50 PM



# BORING B26

PAGE 1 OF 1

BORING DEPTH: 2.8 FEET

**PROJECT NAME:** Hurstbourne Apartments Development

**PROJECT NUMBER:** 088601.00

**CLIENT:** Kennedy International, Inc

**PROJECT LOCATION:** Louisville, Kentucky

**DATE STARTED:** 3/17/22

**COMPLETED:** 3/17/22

**BORING METHOD:** Hollow-stem Augers

**DRILLER:** JK (Strata)

**RIG NO.:** 7822DT

**LOGGED BY:** JWJ

**CHECKED BY:** AEB

| DEPTH (FEET) | SYMBOLIC PROFILE | PROFILE DESCRIPTION                                             | SAMPLE TYPE/NO. INTERVAL | RECOVERY LENGTH (INCHES) | SPT BLOWS PER SIX INCHES | HAMMER EFFICIENCY: 60%<br>DATE:<br>N <sub>60</sub> -- O | DRY DENSITY (pcf) -- ■ | MOISTURE & ATTERBERG LIMITS (%)<br>PL MC LL | <ul style="list-style-type: none"> <li>▼ HAND PENE.</li> <li>■ TORVANE SHEAR</li> <li>○ UNC. COMP.</li> <li>□ VANE SHEAR (PK)</li> <li>× VANE SHEAR (REM)</li> <li>◇ TRIAXIAL (UU) SHEAR</li> <li>STRENGTH (KSF) 1 2 3 4</li> </ul> | REMARKS                    |
|--------------|------------------|-----------------------------------------------------------------|--------------------------|--------------------------|--------------------------|---------------------------------------------------------|------------------------|---------------------------------------------|-------------------------------------------------------------------------------------------------------------------------------------------------------------------------------------------------------------------------------------|----------------------------|
|              |                  |                                                                 |                          |                          |                          |                                                         | 90 100 110 120         |                                             |                                                                                                                                                                                                                                     |                            |
| 0            |                  | 8 inches of TOPSOIL                                             |                          |                          |                          |                                                         |                        |                                             |                                                                                                                                                                                                                                     |                            |
| 0.7          |                  | FAT CLAY- Occasional Roots- Brown and Red- Medium to Stiff (CH) | SB1                      | 8                        | 1<br>2<br>3              | 5                                                       |                        | 26                                          | ▼                                                                                                                                                                                                                                   |                            |
| 2.8          |                  | END OF BORING AT 2.8 FEET.                                      | SB2                      |                          | 50/0"                    | 50+                                                     |                        |                                             |                                                                                                                                                                                                                                     | Auger refusal at 2.8 feet. |
| 5            |                  |                                                                 |                          |                          |                          |                                                         |                        |                                             |                                                                                                                                                                                                                                     |                            |
| 10           |                  |                                                                 |                          |                          |                          |                                                         |                        |                                             |                                                                                                                                                                                                                                     |                            |
| 15           |                  |                                                                 |                          |                          |                          |                                                         |                        |                                             |                                                                                                                                                                                                                                     |                            |
| 20           |                  |                                                                 |                          |                          |                          |                                                         |                        |                                             |                                                                                                                                                                                                                                     |                            |

|                                               |                                                                                                                                                                                                                                                                                                                                                                                                                   |
|-----------------------------------------------|-------------------------------------------------------------------------------------------------------------------------------------------------------------------------------------------------------------------------------------------------------------------------------------------------------------------------------------------------------------------------------------------------------------------|
| <b>GROUNDWATER &amp; BACKFILL INFORMATION</b> | <p>NOTES: 1. The indicated stratification lines are approximate. The in-situ transitions between materials may be gradual.</p> <p>2. The colors depicted on the symbolic profile are solely for visualization purposes and do not necessarily represent the in-situ colors encountered.</p> <p>3. No hammer efficiency data was available, and the graphic output illustrates the field measured blow counts.</p> |
| GROUNDWATER WAS NOT ENCOUNTERED               |                                                                                                                                                                                                                                                                                                                                                                                                                   |
| <b>BACKFILL METHOD:</b> Auger Cuttings        |                                                                                                                                                                                                                                                                                                                                                                                                                   |

4/22/22 3:51:51 PM



# BORING B27

PAGE 1 OF 1

BORING DEPTH: 6.3 FEET

**PROJECT NAME:** Hurstbourne Apartments Development

**PROJECT NUMBER:** 088601.00

**CLIENT:** Kennedy International, Inc

**PROJECT LOCATION:** Louisville, Kentucky

**DATE STARTED:** 3/17/22

**COMPLETED:** 3/17/22

**BORING METHOD:** Hollow-stem Augers

**DRILLER:** JK (Strata)

**RIG NO.:** 7822DT

**LOGGED BY:** JWJ

**CHECKED BY:** AEB

| DEPTH (FEET)               | SYMBOLIC PROFILE | PROFILE DESCRIPTION                                                         | SAMPLE TYPE/NO. INTERVAL | RECOVERY LENGTH (INCHES) | SPT BLOWS PER SIX INCHES | HAMMER EFFICIENCY: 60%<br>DATE:<br>N <sub>60</sub> -- O | DRY DENSITY (pcf) -- ■ |             | MOISTURE & ATTERBERG LIMITS (%)<br>PL MC LL | ▼ HAND PENE.<br>■ TORVANE SHEAR<br>○ UNC. COMP.<br>□ VANE SHEAR (PK)<br>× VANE SHEAR (REM)<br>◆ TRIAXIAL (UU) SHEAR<br>STRENGTH (KSF) 1 2 3 4 | REMARKS                    |
|----------------------------|------------------|-----------------------------------------------------------------------------|--------------------------|--------------------------|--------------------------|---------------------------------------------------------|------------------------|-------------|---------------------------------------------|-----------------------------------------------------------------------------------------------------------------------------------------------|----------------------------|
|                            |                  |                                                                             |                          |                          |                          |                                                         | 90                     | 100 110 120 |                                             |                                                                                                                                               |                            |
| 0                          |                  | 8 inches of TOPSOIL                                                         |                          |                          |                          |                                                         |                        |             |                                             |                                                                                                                                               |                            |
| 0.7                        |                  |                                                                             |                          |                          |                          |                                                         |                        |             |                                             |                                                                                                                                               |                            |
|                            |                  | LEAN CLAY- Brown- Medium (CL)                                               | SB1                      | 18                       | 0<br>2<br>3              | 5                                                       |                        |             | 24                                          |                                                                                                                                               |                            |
| 3.5                        |                  |                                                                             |                          |                          |                          |                                                         |                        |             |                                             |                                                                                                                                               |                            |
|                            |                  | FAT CLAY- Sand Seam at 6.2 feet-<br>Brown and Red- Stiff to Very Stiff (CH) | SB2                      | 17                       | 2<br>4<br>6              | 10                                                      |                        |             | 28                                          |                                                                                                                                               |                            |
| 5                          |                  |                                                                             |                          |                          |                          |                                                         |                        |             |                                             |                                                                                                                                               |                            |
| 6.3                        |                  |                                                                             | SB3                      | 3                        | 50/3"                    | 50+                                                     |                        |             | 32                                          |                                                                                                                                               |                            |
| END OF BORING AT 6.3 FEET. |                  |                                                                             |                          |                          |                          |                                                         |                        |             |                                             |                                                                                                                                               | Auger refusal at 6.3 feet. |

|                                               |                                                                                                                                                                                                                                                                                                                                                                                                           |
|-----------------------------------------------|-----------------------------------------------------------------------------------------------------------------------------------------------------------------------------------------------------------------------------------------------------------------------------------------------------------------------------------------------------------------------------------------------------------|
| <b>GROUNDWATER &amp; BACKFILL INFORMATION</b> | <b>NOTES:</b> 1. The indicated stratification lines are approximate. The in-situ transitions between materials may be gradual.<br>2. The colors depicted on the symbolic profile are solely for visualization purposes and do not necessarily represent the in-situ colors encountered.<br>3. No hammer efficiency data was available, and the graphic output illustrates the field measured blow counts. |
| GROUNDWATER WAS NOT ENCOUNTERED               |                                                                                                                                                                                                                                                                                                                                                                                                           |
| <b>BACKFILL METHOD:</b> Auger Cuttings        |                                                                                                                                                                                                                                                                                                                                                                                                           |

4/22/22 3:51:52 PM



# BORING B28

PAGE 1 OF 1

BORING DEPTH: 5.6 FEET

**PROJECT NAME:** Hurstbourne Apartments Development

**PROJECT NUMBER:** 088601.00

**CLIENT:** Kennedy International, Inc

**PROJECT LOCATION:** Louisville, Kentucky

**DATE STARTED:** 3/14/22

**COMPLETED:** 3/14/22

**BORING METHOD:** Hollow-stem Augers

**DRILLER:** JK (Strata)

**RIG NO.:** 7822DT

**LOGGED BY:** JWJ

**CHECKED BY:** AEB

| DEPTH (FEET) | SYMBOLIC PROFILE | PROFILE DESCRIPTION                             | SAMPLE TYPE/NO. INTERVAL | RECOVERY LENGTH (INCHES) | SPT BLOWS PER SIX INCHES | HAMMER EFFICIENCY: 60%<br>DATE:<br>N <sub>60</sub> -- O | DRY DENSITY (pcf) -- ■ | MOISTURE & ATTERBERG LIMITS (%)<br>PL MC LL | <ul style="list-style-type: none"> <li>▼ HAND PENE.</li> <li>■ TORVANE SHEAR</li> <li>○ UNC. COMP.</li> <li>□ VANE SHEAR (PK)</li> <li>× VANE SHEAR (REM)</li> <li>◇ TRIAXIAL (UU) SHEAR</li> <li>STRENGTH (KSF) 1 2 3 4</li> </ul> | REMARKS                  |
|--------------|------------------|-------------------------------------------------|--------------------------|--------------------------|--------------------------|---------------------------------------------------------|------------------------|---------------------------------------------|-------------------------------------------------------------------------------------------------------------------------------------------------------------------------------------------------------------------------------------|--------------------------|
|              |                  |                                                 |                          |                          |                          |                                                         | 90 100 110 120         |                                             |                                                                                                                                                                                                                                     |                          |
| 0            |                  | 10 inches of TOPSOIL                            |                          |                          |                          |                                                         |                        |                                             |                                                                                                                                                                                                                                     |                          |
| 0.8          |                  | LEAN to FAT CLAY- Brown- Soft to Medium (CL/CH) | SB1                      | 18                       | 1                        | 4                                                       |                        |                                             |                                                                                                                                                                                                                                     |                          |
|              | 2                |                                                 |                          |                          | 26                       |                                                         |                        |                                             |                                                                                                                                                                                                                                     |                          |
| 3.5          |                  | FAT CLAY- Brown and Red- Stiff (CH)             | SB2                      | 10                       | 1                        | 12                                                      |                        |                                             |                                                                                                                                                                                                                                     |                          |
|              | 3                |                                                 |                          |                          | 24                       |                                                         |                        |                                             |                                                                                                                                                                                                                                     |                          |
|              | 9                |                                                 |                          |                          | 31                       |                                                         |                        |                                             |                                                                                                                                                                                                                                     |                          |
| 5            |                  |                                                 | SB3                      | 4                        | 21                       | 50+                                                     |                        |                                             |                                                                                                                                                                                                                                     | Auger refusal at 5 feet. |
| 5.6          |                  | END OF BORING AT 5.6 FEET.                      |                          |                          |                          |                                                         |                        |                                             |                                                                                                                                                                                                                                     |                          |

|                                               |
|-----------------------------------------------|
| <b>GROUNDWATER &amp; BACKFILL INFORMATION</b> |
| GROUNDWATER WAS NOT ENCOUNTERED               |
| <b>BACKFILL METHOD:</b> Auger Cuttings        |

NOTES: 1. The indicated stratification lines are approximate. The in-situ transitions between materials may be gradual.  
 2. The colors depicted on the symbolic profile are solely for visualization purposes and do not necessarily represent the in-situ colors encountered.  
 3. No hammer efficiency data was available, and the graphic output illustrates the field measured blow counts.

4/22/22 3:51:53 PM



# BORING B29

PAGE 1 OF 1

BORING DEPTH: 3.5 FEET

**PROJECT NAME:** Hurstbourne Apartments Development

**PROJECT NUMBER:** 088601.00

**CLIENT:** Kennedy International, Inc

**PROJECT LOCATION:** Louisville, Kentucky

**DATE STARTED:** 3/14/22

**COMPLETED:** 3/14/22

**BORING METHOD:** Hollow-stem Augers

**DRILLER:** JK (Strata)

**RIG NO.:** 7822DT

**LOGGED BY:** JWJ

**CHECKED BY:** AEB

| DEPTH (FEET) | SYMBOLIC PROFILE | PROFILE DESCRIPTION        | SAMPLE TYPE/NO. INTERVAL | RECOVERY LENGTH (INCHES) | SPT BLOWS PER SIX INCHES | HAMMER EFFICIENCY: 60%<br>DATE:<br>N <sub>60</sub> -- O | DRY DENSITY (pcf) -- ■ |             | MOISTURE & ATTERBERG LIMITS (%)<br>PL MC LL | <ul style="list-style-type: none"> <li>▼ HAND PENE.</li> <li>■ TORVANE SHEAR</li> <li>○ UNC. COMP.</li> <li>□ VANE SHEAR (PK)</li> <li>× VANE SHEAR (REM)</li> <li>◇ TRIAXIAL (UU) SHEAR</li> <li>STRENGTH (KSF)</li> </ul> | REMARKS                    |
|--------------|------------------|----------------------------|--------------------------|--------------------------|--------------------------|---------------------------------------------------------|------------------------|-------------|---------------------------------------------|-----------------------------------------------------------------------------------------------------------------------------------------------------------------------------------------------------------------------------|----------------------------|
|              |                  |                            |                          |                          |                          |                                                         | 90                     | 100 110 120 |                                             |                                                                                                                                                                                                                             |                            |
| 0            |                  | 8 inches of TOPSOIL        |                          |                          |                          |                                                         |                        |             |                                             |                                                                                                                                                                                                                             |                            |
| 0.7          |                  |                            | SB1                      | 18                       | 1<br>3<br>4              | 7                                                       |                        | 23          |                                             |                                                                                                                                                                                                                             |                            |
| 3.5          |                  | END OF BORING AT 3.5 FEET. | SB2                      | 2                        | 50/2"                    | 50+                                                     |                        | 26          |                                             |                                                                                                                                                                                                                             | Auger refusal at 3.5 feet. |
| 5            |                  |                            |                          |                          |                          |                                                         |                        |             |                                             |                                                                                                                                                                                                                             |                            |
| 10           |                  |                            |                          |                          |                          |                                                         |                        |             |                                             |                                                                                                                                                                                                                             |                            |
| 15           |                  |                            |                          |                          |                          |                                                         |                        |             |                                             |                                                                                                                                                                                                                             |                            |
| 20           |                  |                            |                          |                          |                          |                                                         |                        |             |                                             |                                                                                                                                                                                                                             |                            |

|                                               |
|-----------------------------------------------|
| <b>GROUNDWATER &amp; BACKFILL INFORMATION</b> |
| GROUNDWATER WAS NOT ENCOUNTERED               |
| <b>BACKFILL METHOD:</b> Auger Cuttings        |

NOTES: 1. The indicated stratification lines are approximate. The in-situ transitions between materials may be gradual.  
 2. The colors depicted on the symbolic profile are solely for visualization purposes and do not necessarily represent the in-situ colors encountered.  
 3. No hammer efficiency data was available, and the graphic output illustrates the field measured blow counts.



4/22/22 3:51:53 PM



# BORING B30

PAGE 1 OF 1

BORING DEPTH: 3 FEET

**PROJECT NAME:** Hurstbourne Apartments Development

**PROJECT NUMBER:** 088601.00

**CLIENT:** Kennedy International, Inc

**PROJECT LOCATION:** Louisville, Kentucky

**DATE STARTED:** 3/14/22

**COMPLETED:** 3/14/22

**BORING METHOD:** Hollow-stem Augers

**DRILLER:** JK (Strata)

**RIG NO.:** 7822DT

**LOGGED BY:** JWJ

**CHECKED BY:** AEB

| DEPTH (FEET) | SYMBOLIC PROFILE | PROFILE DESCRIPTION                                            | SAMPLE TYPE/NO. INTERVAL | RECOVERY LENGTH (INCHES) | SPT BLOWS PER SIX INCHES | HAMMER EFFICIENCY: 60%<br>DATE:<br>N <sub>60</sub> -- O | DRY DENSITY (pcf) -- ■ | MOISTURE & ATTERBERG LIMITS (%)<br>PL MC LL | <ul style="list-style-type: none"> <li>▼ HAND PENE.</li> <li>■ TORVANE SHEAR</li> <li>○ UNC. COMP.</li> <li>□ VANE SHEAR (PK)</li> <li>× VANE SHEAR (REM)</li> <li>◇ TRIAXIAL (UU) SHEAR</li> <li>STRENGTH (KSF)</li> </ul> | REMARKS                    |
|--------------|------------------|----------------------------------------------------------------|--------------------------|--------------------------|--------------------------|---------------------------------------------------------|------------------------|---------------------------------------------|-----------------------------------------------------------------------------------------------------------------------------------------------------------------------------------------------------------------------------|----------------------------|
|              |                  |                                                                |                          |                          |                          |                                                         | 90 100 110 120         |                                             |                                                                                                                                                                                                                             |                            |
| 0            |                  | 7 inches of TOPSOIL                                            |                          |                          |                          |                                                         |                        |                                             |                                                                                                                                                                                                                             |                            |
| 0.6          |                  | LEAN to FAT CLAY- Frequent Roots- Brown and Gray- Soft (CL/CH) | SB1                      | 14                       | 1<br>2                   | 4                                                       |                        |                                             |                                                                                                                                                                                                                             |                            |
| 2.9          |                  | Highly to Completely Weathered SANDSTONE- Brown                | SB2                      | 0.25                     | 50/1"                    | 50+                                                     |                        |                                             |                                                                                                                                                                                                                             | Auger refusal at 2.9 feet. |
| 3.0          |                  | END OF BORING AT 3.0 FEET.                                     |                          |                          |                          |                                                         |                        |                                             |                                                                                                                                                                                                                             |                            |
| 5            |                  |                                                                |                          |                          |                          |                                                         |                        |                                             |                                                                                                                                                                                                                             |                            |
| 10           |                  |                                                                |                          |                          |                          |                                                         |                        |                                             |                                                                                                                                                                                                                             |                            |
| 15           |                  |                                                                |                          |                          |                          |                                                         |                        |                                             |                                                                                                                                                                                                                             |                            |
| 20           |                  |                                                                |                          |                          |                          |                                                         |                        |                                             |                                                                                                                                                                                                                             |                            |

**GROUNDWATER & BACKFILL INFORMATION**

GROUNDWATER WAS NOT ENCOUNTERED

**BACKFILL METHOD:** Auger Cuttings

**NOTES:** 1. The indicated stratification lines are approximate. The in-situ transitions between materials may be gradual.  
 2. The colors depicted on the symbolic profile are solely for visualization purposes and do not necessarily represent the in-situ colors encountered.  
 3. No hammer efficiency data was available, and the graphic output illustrates the field measured blow counts.

4/22/22 3:51:54 PM



# BORING B31

PAGE 1 OF 1

BORING DEPTH: 8 FEET

**PROJECT NAME:** Hurstbourne Apartments Development

**PROJECT NUMBER:** 088601.00

**CLIENT:** Kennedy International, Inc

**PROJECT LOCATION:** Louisville, Kentucky

**DATE STARTED:** 3/14/22

**COMPLETED:** 3/14/22

**BORING METHOD:** Hollow-stem Augers

**DRILLER:** JK (Strata)

**RIG NO.:** 7822DT

**LOGGED BY:** JWJ

**CHECKED BY:** AEB

| DEPTH (FEET) | SYMBOLIC PROFILE | PROFILE DESCRIPTION                                          | SAMPLE TYPE/NO. INTERVAL | RECOVERY LENGTH (INCHES) | SPT BLOWS PER SIX INCHES | HAMMER EFFICIENCY: 60%<br>DATE:<br>N <sub>60</sub> -- O | DRY DENSITY (pcf) -- ■ | MOISTURE & ATTERBERG LIMITS (%)<br>PL MC LL | ▼ HAND PENE.<br>■ TORVANE SHEAR<br>○ UNC. COMP.<br>□ VANE SHEAR (PK)<br>× VANE SHEAR (REM)<br>◆ TRIAXIAL (UU) SHEAR<br>STRENGTH (KSF) 1 2 3 4 | REMARKS                    |
|--------------|------------------|--------------------------------------------------------------|--------------------------|--------------------------|--------------------------|---------------------------------------------------------|------------------------|---------------------------------------------|-----------------------------------------------------------------------------------------------------------------------------------------------|----------------------------|
|              |                  |                                                              |                          |                          |                          |                                                         | 90 100 110 120         |                                             |                                                                                                                                               |                            |
| 0            |                  | 8 inches of TOPSOIL                                          |                          |                          |                          |                                                         |                        |                                             |                                                                                                                                               |                            |
| 0.7          |                  |                                                              |                          |                          |                          |                                                         |                        |                                             |                                                                                                                                               |                            |
| 3.5          |                  | FAT CLAY- Frequent Rock Fragments- Brown and Red- Soft (CH)  | SB1                      | 15                       | 1<br>2<br>2              | 4                                                       |                        | 26                                          | ▼                                                                                                                                             |                            |
| 5            |                  | FAT CLAY- Frequent Rock Fragments- Brown and Red- Stiff (CH) | SB2                      | 16                       | 4<br>5<br>6              | 11                                                      |                        | 26                                          | ▼                                                                                                                                             |                            |
| 6.0          |                  | FAT CLAY- Brown- Stiff to Very Stiff (CH)                    | SB3                      | 14                       | 5<br>8<br>9              | 17                                                      |                        | 27                                          | ▼                                                                                                                                             |                            |
| 8.0          |                  | END OF BORING AT 8.0 FEET.                                   | SB4                      | 0.25                     | 50/3"                    |                                                         |                        |                                             |                                                                                                                                               | Auger refusal at 7.8 feet. |

|                                               |
|-----------------------------------------------|
| <b>GROUNDWATER &amp; BACKFILL INFORMATION</b> |
| GROUNDWATER WAS NOT ENCOUNTERED               |
| <b>BACKFILL METHOD:</b> Auger Cuttings        |

NOTES: 1. The indicated stratification lines are approximate. The in-situ transitions between materials may be gradual.  
 2. The colors depicted on the symbolic profile are solely for visualization purposes and do not necessarily represent the in-situ colors encountered.  
 3. No hammer efficiency data was available, and the graphic output illustrates the field measured blow counts.

## **APPENDIX B**

### **IMPORTANT INFORMATION ABOUT THIS GEOTECHNICAL ENGINEERING REPORT**

#### **GENERAL COMMENTS**

#### **LABORATORY TESTING PROCEDURES**

# Important Information about This

# Geotechnical-Engineering Report

Subsurface problems are a principal cause of construction delays, cost overruns, claims, and disputes.

While you cannot eliminate all such risks, you can manage them. The following information is provided to help.

**The Geoprofessional Business Association (GBA) has prepared this advisory to help you – assumedly a client representative – interpret and apply this geotechnical-engineering report as effectively as possible. In that way, you can benefit from a lowered exposure to problems associated with subsurface conditions at project sites and development of them that, for decades, have been a principal cause of construction delays, cost overruns, claims, and disputes. If you have questions or want more information about any of the issues discussed herein, contact your GBA-member geotechnical engineer. Active engagement in GBA exposes geotechnical engineers to a wide array of risk-confrontation techniques that can be of genuine benefit for everyone involved with a construction project.**

## Understand the Geotechnical-Engineering Services Provided for this Report

Geotechnical-engineering services typically include the planning, collection, interpretation, and analysis of exploratory data from widely spaced borings and/or test pits. Field data are combined with results from laboratory tests of soil and rock samples obtained from field exploration (if applicable), observations made during site reconnaissance, and historical information to form one or more models of the expected subsurface conditions beneath the site. Local geology and alterations of the site surface and subsurface by previous and proposed construction are also important considerations. Geotechnical engineers apply their engineering training, experience, and judgment to adapt the requirements of the prospective project to the subsurface model(s). Estimates are made of the subsurface conditions that will likely be exposed during construction as well as the expected performance of foundations and other structures being planned and/or affected by construction activities.

The culmination of these geotechnical-engineering services is typically a geotechnical-engineering report providing the data obtained, a discussion of the subsurface model(s), the engineering and geologic engineering assessments and analyses made, and the recommendations developed to satisfy the given requirements of the project. These reports may be titled investigations, explorations, studies, assessments, or evaluations. Regardless of the title used, the geotechnical-engineering report is an engineering interpretation of the subsurface conditions within the context of the project and does not represent a close examination, systematic inquiry, or thorough investigation of all site and subsurface conditions.

## Geotechnical-Engineering Services are Performed for Specific Purposes, Persons, and Projects, and At Specific Times

Geotechnical engineers structure their services to meet the specific needs, goals, and risk management preferences of their clients. A geotechnical-engineering study conducted for a given civil engineer

will not likely meet the needs of a civil-works constructor or even a different civil engineer. Because each geotechnical-engineering study is unique, each geotechnical-engineering report is unique, prepared *solely* for the client.

Likewise, geotechnical-engineering services are performed for a specific project and purpose. For example, it is unlikely that a geotechnical-engineering study for a refrigerated warehouse will be the same as one prepared for a parking garage; and a few borings drilled during a preliminary study to evaluate site feasibility will not be adequate to develop geotechnical design recommendations for the project.

Do not rely on this report if your geotechnical engineer prepared it:

- for a different client;
- for a different project or purpose;
- for a different site (that may or may not include all or a portion of the original site); or
- before important events occurred at the site or adjacent to it; e.g., man-made events like construction or environmental remediation, or natural events like floods, droughts, earthquakes, or groundwater fluctuations.

Note, too, the reliability of a geotechnical-engineering report can be affected by the passage of time, because of factors like changed subsurface conditions; new or modified codes, standards, or regulations; or new techniques or tools. *If you are the least bit uncertain about the continued reliability of this report, contact your geotechnical engineer before applying the recommendations in it.* A minor amount of additional testing or analysis after the passage of time – if any is required at all – could prevent major problems.

## Read this Report in Full

Costly problems have occurred because those relying on a geotechnical-engineering report did not read the report in its entirety. Do not rely on an executive summary. Do not read selective elements only. *Read and refer to the report in full.*

## You Need to Inform Your Geotechnical Engineer About Change

Your geotechnical engineer considered unique, project-specific factors when developing the scope of study behind this report and developing the confirmation-dependent recommendations the report conveys. Typical changes that could erode the reliability of this report include those that affect:

- the site's size or shape;
- the elevation, configuration, location, orientation, function or weight of the proposed structure and the desired performance criteria;
- the composition of the design team; or
- project ownership.

As a general rule, *always* inform your geotechnical engineer of project or site changes – even minor ones – and request an assessment of their impact. *The geotechnical engineer who prepared this report cannot accept*

responsibility or liability for problems that arise because the geotechnical engineer was not informed about developments the engineer otherwise would have considered.

### Most of the “Findings” Related in This Report Are Professional Opinions

Before construction begins, geotechnical engineers explore a site’s subsurface using various sampling and testing procedures. *Geotechnical engineers can observe actual subsurface conditions only at those specific locations where sampling and testing is performed.* The data derived from that sampling and testing were reviewed by your geotechnical engineer, who then applied professional judgement to form opinions about subsurface conditions throughout the site. Actual sitewide-subsurface conditions may differ – maybe significantly – from those indicated in this report. Confront that risk by retaining your geotechnical engineer to serve on the design team through project completion to obtain informed guidance quickly, whenever needed.

### This Report’s Recommendations Are Confirmation-Dependent

The recommendations included in this report – including any options or alternatives – are confirmation-dependent. In other words, they are not final, because the geotechnical engineer who developed them relied heavily on judgement and opinion to do so. Your geotechnical engineer can finalize the recommendations *only after observing actual subsurface conditions* exposed during construction. If through observation your geotechnical engineer confirms that the conditions assumed to exist actually do exist, the recommendations can be relied upon, assuming no other changes have occurred. *The geotechnical engineer who prepared this report cannot assume responsibility or liability for confirmation-dependent recommendations if you fail to retain that engineer to perform construction observation.*

### This Report Could Be Misinterpreted

Other design professionals’ misinterpretation of geotechnical-engineering reports has resulted in costly problems. Confront that risk by having your geotechnical engineer serve as a continuing member of the design team, to:

- confer with other design-team members;
- help develop specifications;
- review pertinent elements of other design professionals’ plans and specifications; and
- be available whenever geotechnical-engineering guidance is needed.

You should also confront the risk of constructors misinterpreting this report. Do so by retaining your geotechnical engineer to participate in prebid and preconstruction conferences and to perform construction-phase observations.

### Give Constructors a Complete Report and Guidance

Some owners and design professionals mistakenly believe they can shift unanticipated-subsurface-conditions liability to constructors by limiting the information they provide for bid preparation. To help prevent the costly, contentious problems this practice has caused, include the complete geotechnical-engineering report, along with any attachments or appendices, with your contract documents, *but be certain to note*

*conspicuously that you’ve included the material for information purposes only.* To avoid misunderstanding, you may also want to note that “informational purposes” means constructors have no right to rely on the interpretations, opinions, conclusions, or recommendations in the report. Be certain that constructors know they may learn about specific project requirements, including options selected from the report, *only* from the design drawings and specifications. Remind constructors that they may perform their own studies if they want to, and *be sure to allow enough time* to permit them to do so. Only then might you be in a position to give constructors the information available to you, while requiring them to at least share some of the financial responsibilities stemming from unanticipated conditions. Conducting prebid and preconstruction conferences can also be valuable in this respect.

### Read Responsibility Provisions Closely

Some client representatives, design professionals, and constructors do not realize that geotechnical engineering is far less exact than other engineering disciplines. This happens in part because soil and rock on project sites are typically heterogeneous and not manufactured materials with well-defined engineering properties like steel and concrete. That lack of understanding has nurtured unrealistic expectations that have resulted in disappointments, delays, cost overruns, claims, and disputes. To confront that risk, geotechnical engineers commonly include explanatory provisions in their reports. Sometimes labeled “limitations,” many of these provisions indicate where geotechnical engineers’ responsibilities begin and end, to help others recognize their own responsibilities and risks. *Read these provisions closely.* Ask questions. Your geotechnical engineer should respond fully and frankly.

### Geoenvironmental Concerns Are Not Covered

The personnel, equipment, and techniques used to perform an environmental study – e.g., a “phase-one” or “phase-two” environmental site assessment – differ significantly from those used to perform a geotechnical-engineering study. For that reason, a geotechnical-engineering report does not usually provide environmental findings, conclusions, or recommendations; e.g., about the likelihood of encountering underground storage tanks or regulated contaminants. *Unanticipated subsurface environmental problems have led to project failures.* If you have not obtained your own environmental information about the project site, ask your geotechnical consultant for a recommendation on how to find environmental risk-management guidance.

### Obtain Professional Assistance to Deal with Moisture Infiltration and Mold

While your geotechnical engineer may have addressed groundwater, water infiltration, or similar issues in this report, the engineer’s services were not designed, conducted, or intended to prevent migration of moisture – including water vapor – from the soil through building slabs and walls and into the building interior, where it can cause mold growth and material-performance deficiencies. Accordingly, *proper implementation of the geotechnical engineer’s recommendations will not of itself be sufficient to prevent moisture infiltration.* *Confront the risk of moisture infiltration* by including building-envelope or mold specialists on the design team. *Geotechnical engineers are not building-envelope or mold specialists.*



Telephone: 301/565-2733

e-mail: [info@geoprofessional.org](mailto:info@geoprofessional.org) [www.geoprofessional.org](http://www.geoprofessional.org)



## GENERAL COMMENTS

### BASIS OF GEOTECHNICAL REPORT

This report has been prepared in accordance with generally accepted geotechnical engineering practices to assist in the design and/or evaluation of this project. If the project plans, design criteria, and other project information referenced in this report and utilized by SME to prepare our recommendations are changed, the conclusions and recommendations contained in this report are not considered valid unless the changes are reviewed, and the conclusions and recommendations of this report are modified or approved in writing by our office.

The discussions and recommendations submitted in this report are based on the available project information, described in this report, and the geotechnical data obtained from the field exploration at the locations indicated in the report. Variations in the soil and groundwater conditions commonly occur between or away from sampling locations. The nature and extent of the variations may not become evident until the time of construction. If significant variations are observed during construction, SME should be contacted to reevaluate the recommendations of this report. SME should be retained to continue our services through construction to observe and evaluate the actual subsurface conditions relative to the recommendations made in this report.

In the process of obtaining and testing samples and preparing this report, procedures are followed that represent reasonable and accepted practice in the field of soil and foundation engineering. Specifically, field logs are prepared during the field exploration that describe field occurrences, sampling locations, and other information. Samples obtained in the field are frequently subjected to additional testing and reclassification in the laboratory and differences may exist between the field logs and the report logs. The engineer preparing the report reviews the field logs, laboratory classifications, and test data and then prepares the report logs. Our recommendations are based on the contents of the report logs and the information contained therein.

### REVIEW OF DESIGN DETAILS, PLANS, AND SPECIFICATIONS

SME should be retained to review the design details, project plans, and specifications to verify those documents are consistent with the recommendations contained in this report.

### REVIEW OF REPORT INFORMATION WITH PROJECT TEAM

Implementation of our recommendations may affect the design, construction, and performance of the proposed improvements, along with the potential inherent risks involved with the proposed construction. The client and key members of the design team, including SME, should discuss the issues covered in this report so that the issues are understood and applied in a manner consistent with the owner's budget, tolerance of risk, and expectations for performance and maintenance.

### FIELD VERIFICATION OF GEOTECHNICAL CONDITIONS

SME should be retained to verify the recommendations of this report are properly implemented during construction. This may avoid misinterpretation of our recommendations by other parties and will allow us to review and modify our recommendations if variations in the site subsurface conditions are encountered.

### PROJECT INFORMATION FOR CONTRACTOR

This report and any future addenda or other reports regarding this site should be made available to prospective contractors prior to submitting their proposals for their information only and to supply them with facts relative to the subsurface evaluation and laboratory test results. If the selected contractor encounters subsurface conditions during construction, which differ from those presented in this report, the contractor should promptly describe the nature and extent of the differing conditions in writing and SME should be notified so that we can verify those conditions. The construction contract should include provisions for dealing with differing conditions and contingency funds should be reserved for potential problems during earthwork and foundation construction. We would be pleased to assist you in developing the contract provisions based on our experience.

The contractor should be prepared to handle environmental conditions encountered at this site, which may affect the excavation, removal, or disposal of soil; dewatering of excavations; and health and safety of workers. Any Environmental Assessment reports prepared for this site should be made available for review by bidders and the successful contractor.

### THIRD PARTY RELIANCE/REUSE OF THIS REPORT

This report has been prepared solely for the use of our Client for the project specifically described in this report. This report cannot be relied upon by other parties not involved in the project, unless specifically allowed by SME in writing. SME also is not responsible for the interpretation by other parties of the geotechnical data and the recommendations provided herein.

# LABORATORY TESTING PROCEDURES

## VISUAL ENGINEERING CLASSIFICATION

Visual classification was performed on recovered samples. The appended General Notes and Unified Soil Classification System (USCS) sheets include a brief summary of the general method used visually classify the soil and assign an appropriate USCS group symbol. The estimated group symbol, according to the USCS, is shown in parentheses following the textural description of the various strata on the boring logs appended to this report. The soil descriptions developed from visual classifications are sometimes modified to reflect the results of laboratory testing.

## MOISTURE CONTENT

Moisture content tests were performed by weighing samples from the field at their in-situ moisture condition. These samples were then dried at a constant temperature (approximately 110° C) overnight in an oven. After drying, the samples were weighed to determine the dry weight of the sample and the weight of the water that was expelled during drying. The moisture content of the specimen is expressed as a percent and is the weight of the water compared to the dry weight of the specimen.

## HAND PENETROMETER TESTS

In the hand penetrometer test, the unconfined compressive strength of a cohesive soil sample is estimated by measuring the resistance of the sample to the penetration of a small calibrated, spring-loaded cylinder. The maximum capacity of the penetrometer is 4.5 tons per square-foot (tsf). Theoretically, the undrained shear strength of the cohesive sample is one-half the unconfined compressive strength. The undrained shear strength (based on the hand penetrometer test) presented on the boring logs is reported in units of kips per square-foot (ksf).

## TORVANE SHEAR TESTS

In the Torvane test, the shear strength of a low strength, cohesive soil sample is estimated by measuring the resistance of the sample to a torque applied through vanes inserted into the sample. The undrained shear strength of the samples is measured from the maximum torque required to shear the sample and is reported in units of kips per square-foot (ksf).

## LOSS-ON-IGNITION (ORGANIC CONTENT) TESTS

Loss-on-ignition (LOI) tests are conducted by first weighing the sample and then heating the sample to dry the moisture from the sample (in the same manner as determining the moisture content of the soil). The sample is then re-weighed to determine the dry weight and then heated for 4 hours in a muffle furnace at a high temperature (approximately 440° C). After cooling, the sample is re-weighed to calculate the amount of ash remaining, which in turn is used to determine the amount of organic matter burned from the original dry sample. The organic matter content of the specimen is expressed as a percent compared to the dry weight of the sample.

## ATTERBERG LIMITS TESTS

Atterberg limits tests consist of two components. The plastic limit of a cohesive sample is determined by rolling the sample into a thread and the plastic limit is the moisture content where a 1/8-inch thread begins to crumble. The liquid limit is determined by placing a 1/2-inch thick soil pat into the liquid limits cup and using a grooving tool to divide the soil pat in half. The cup is then tapped on the base of the liquid limits device using a crank handle. The number of drops of the cup to close the gap formed by the grooving tool 1/2 inch is recorded along with the corresponding moisture content of the sample. This procedure is repeated several times at different moisture contents and a graph of moisture content and the corresponding number of blows is plotted. The liquid limit is defined as the moisture content at a nominal 25 drops of the cup. From this test, the plasticity index can be determined by subtracting the plastic limit from the liquid limit.



*Passionate People Building  
and Revitalizing our World*

