

MSD NOTES

- EXISTING SANITARY SEWER IS TREATED BY THE WATER QUALITY TREATMENT FACILITY.
- DOWN STREAM CAPACITY TO BE VERIFIED PRIOR TO MSD CONSTRUCTION PLAN APPROVAL. ON-SITE MODIFICATIONS MAY BE REQUIRED.
- APPROVAL FROM MSD SANITARY SEWER DEPARTMENT PRIOR TO CONSTRUCTION PLAN APPROVAL
- N/A
- NO DETENTION REQ. PER PLAN 9-12-90. DETENTION BEING ACCOUNTED FOR BY FORMER JUMBO MIDDLETOWN GOLF AND GAME DETENTION BASIN.

EROSION CONTROL SCHEDULE:

ALL EROSION AND SEDIMENT MEASURES ARE TO BE IN PLACE AND INSPECTED PRIOR TO ANY CLEARING OR GRADING. THESE MEASURES SHALL BE CHECKED AND INSPECTED ON A REGULAR BASIS AND AT NO TIME SHALL BE REMOVE UNTIL COMPLETION OF PROJECT AND FINAL APPROVAL FROM CITY STORM WATER DEPT.

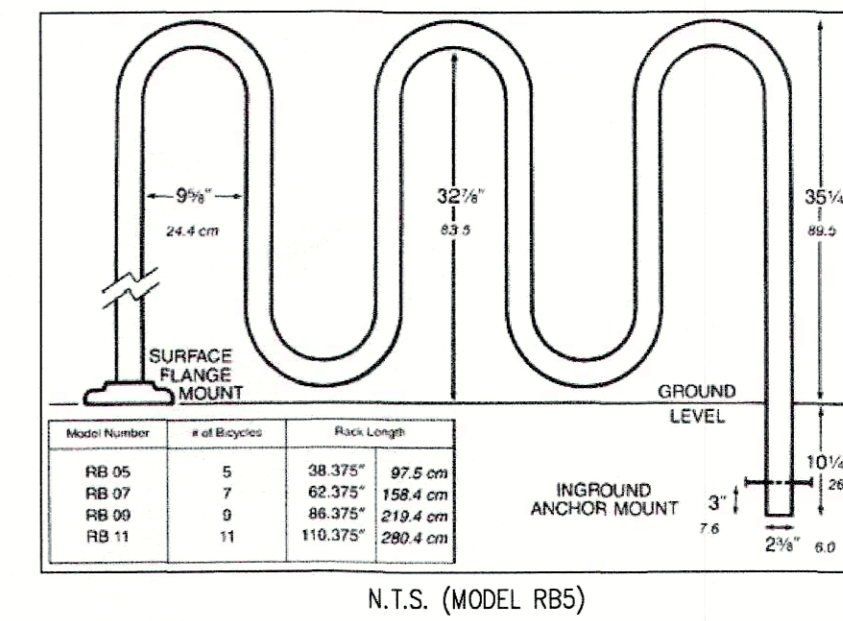
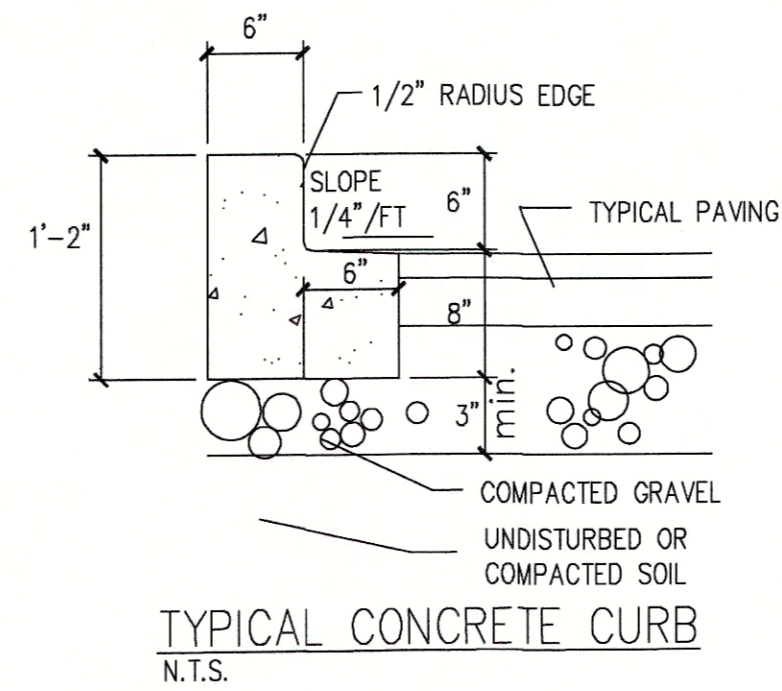

BICYCLE PARKING DETAIL N.T.S.

PROJECT ADDRESS

13200 SHELBYVILLE RD
LOUISVILLE, KY 40241

PROJECT DATA

TAX BLOCK 437 LOT 30
DEED BOOK 10803 PAGE 844
TOTAL SITE AREA = 0.876 ACRES
EXISTING ZONING = C-2
FORM DISTRICT = SUBURBAN MARKETPLACE CORRIDOR

EXISTING USE = DRIVE THRU RESTAURANT
PROPOSED USE = AUTOMOBILE REPAIR GARAGE
BUILDING FOOTPRINT = 8,250 SF

MAX F.A.R. = 5.0
F.A.R. = 0.22
BUILDING HEIGHT = 1 STORY RETAIL BLDG. (38'4" MAX.)
PARKING
AUTOMOBILE REPAIR : 2 SPACES PER BAY
PLUS EMPLOYEE PARKING
8 BAYS = 16 SPACES
8 EMPLOYEES PER SHIFT = 8 SPACES

AUTO SERVICE ESTABLISHMENTS
TOTAL SPACES PROVIDED = 29 SPACES (8 INTERIOR, 21 EXTERIOR)
PERMANENT BIKE PARKING (INSIDE) 2 SP.
TEMPORARY BIKE PARKING (OUTSIDE) 5 SP.
TOTAL BIKE SPACES PROVIDED = 7 SPACES

SETRACK REQUIREMENTS
FRONT YARD/STREET-SIDE: > ONE-HALF STANDARD ABUTTING R/W WIDTH
REAR YARD/SIDE YARD: NONE (UNLESS ABUTTING RESIDENTIAL DISTRICT)
MAXIMUM BUILDING HEIGHT: 60'

V.U.A. DATA

TOTAL V.U.A. = 12,459 SF
ILA REQUIRED = 935 SF
ILA PROVIDED = 957 SF

ISR CALCULATIONS

TOTAL SITE AREA = 38,170 SF
EXISTING IMPERVIOUS AREA = 22,900 SF
EXISTING ISR = 0.60
PROPOSED IMPERVIOUS AREA = 27,526 SF
PROPOSED ISR = 0.72
TOTAL LAND DISTURBANCE = 0.86 ACRES

TREE CANOPY CALCULATIONS

TOTAL SITE AREA = 38,170 SF
TOTAL TREE CANOPY AREA REQUIRED = 7,634 SF (20%)
EXISTING TREE CANOPY TO BE PRESERVED = 0 SF (0%)
PROPOSED TREE CANOPY TO BE PLANTED = 7,634 SF (20%)
TOTAL TREE CANOPY PROVIDED = LESS THAN 20% BUILDING INCREASE/IMPERVIOUS AREA PER 10.1.2.B.3

OWNER:

SDI, REAL ESTATE LLC
4007 HILLSBORO PIKE
NASHVILLE, TN 37215

DEVELOPER

THOMPSON THRIFT
111 MONUMENT CIRCLE, SUITE 1600
INDIANAPOLIS, IN 46204
OFFICE: (317) 853-5482
FAX: (317) 454-8026

PREPARER/ENGINEER:

LEESMAN ENGINEERING & ASSOC.
STEVEN J. LEESMAN P.E.
2720 TOPIC HILLS DRIVE
CINCINNATI, OHIO 45248
PH 513-417-0420, FAX 513-347-3495

RECEIVED
OCT 23 2017
PLANNING & DESIGN SERVICES

VICINITY MAP

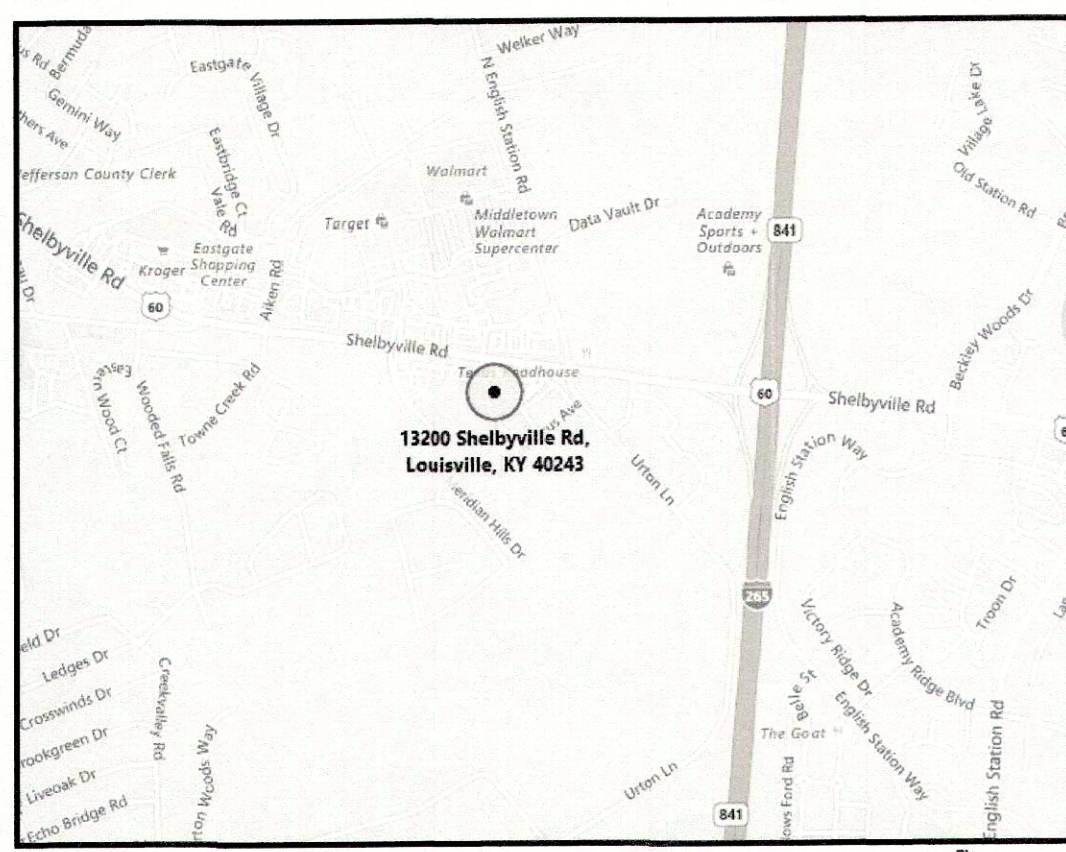

GENERAL NOTES

- Parking areas and drive lanes to be a hard and durable surface.
- By scaled map location and graphic plotting only, the subject property lies within Flood Zone "X", that is defined as outside 500-year flood plain per Flood Insurance Rate Map Community and Panel Number 21111C0049E, with an effective date of DECEMBER 5, 2006.
- Drainage pattern depicted by arrows (==>) is for conceptual purposes. Final configuration and size of drainage pipes and channels shall be determined during the construction plan design process. Drainage facilities shall conform to MSD requirements.
- Erosion & Silt Control: Prior to any construction activities on the site a Erosion & Silt Control Plan shall be provided to MSD for approval.
- Construction fencing shall be erected prior to any construction or grading activities preventing compaction of root systems of trees to be preserved. The fencing shall enclose the area beneath the dripline of the tree canopy and shall remain in place. No parking, material storage, or construction activities shall be permitted within the fenced area.
- A Tree Preservation Plan will be submitted for approval to the Planning Commission for approval prior to beginning construction.
- All dumpsters and service structures are to be screened per Chapter 10.
- The Louisville Water Company will provide Domestic Water Service to the site. The expenses for any improvements required to provide service to the site will be the responsibility of the owner/developer.
- All lighting on the site shall be directed down and away from adjacent residential uses.
- This site is subject to the Binding Elements in Docket No. 9-12-90 of record in the Office of the Louisville & Jefferson County Planning Commission.
- Related Case: NONE
- Sanitary sewer service will be provided by connection and subject to applicable fees.
- Site will be subject to MSD Regional Facilities Fee.
- VUA and structure are existing and do not require variances in accordance with 20' rear yard.
- All signs of this development shall be in compliance with Chapter 8 of the Louisville Metro Land Development Code and all applicable ordinances.
- Off-street loading and refuse collection areas shall be located and screened so as not to be visible from adjacent public streets and residential uses.
- Accessory structures shall be in compliance with sections 5.5.5 and 10.2.6 of the Louisville Metro Land Development Code.

EROSION CONTROL NOTES:

- ALL AREAS THAT ARE UNPROTECTED SHALL BE SEEDED IN A TIMELY MANNER. NO UNPROTECTED AREA SHALL BE LEFT UNSEEDED FOR MORE THAN 14 DAYS.
- USE TEMPORARY SEEDING AND/OR VEGETATION TO PROTECT AREAS THAT ARE BARE SOIL
- USE OF SPRINKLERS OVER DRY SOIL TO KEEP DUST TO A MINIMUM.
- NO WORK SHALL COMMENCE UNTIL ALL SEDIMENT AND EROSION PROTECTION MEASURES HAVE BEEN INSTALLED AND INSPECTED.
- ALL SEDIMENT AND EROSION MEASURES ARE TO BE INSPECTED ON A REGULAR BASIS, IF AT ANY TIME THESE MEASURES ARE TO FAIL THE CONTRACTOR IS TO REPAIR IMMEDIATELY.
- UPON COMPLETION OF GRADING A MINIMUM OF 4 INCHES OF TOPSOIL IS TO BE PLACED OVER GRASSED AREAS. FINAL GRASS SEEDING IS TO BE PER LANDSCAPE ARCHITECT PLAN.
- WHEN PROJECT IS COMPLETE AND INSPECTED BY CITY STORM WATER DEPT. THE EROSION CONTROL MEASURES ARE TO BE REMOVED AND SEEDED PER LANDSCAPE PLAN FINAL SEEDING CHART.
- CONTRACTOR TO PROVIDE AN AREA FOR CONCRETE WASH DOWN AND EQUIPMENT FUELING IN ACCORDANCE WITH METRO CP-10 AND CP-13, RESPECTIVELY. CONTRACTOR TO COORDINATE EXACT LOCATION WITH NPDES DEPARTMENT DURING PRE CONSTRUCTION MEETING. CONTROL OF OTHER SITE WASTES SUCH AS DISCARDED BUILDING MATERIALS, CHEMICALS, LITTER, AND SANITARY WASTES THAT MAY CAUSE ADVERSE IMPACTS TO WATER QUALITY IS ALSO REQUIRED BY THE GRADING PERMITTEE.
- STEEP SLOPES (35% GRADE OR GREATER) SHALL BE TEMPORARILY STABILIZED NOT LATER THAN 7 DAYS AFTER CONSTRUCTION ACTIVITY ON THE SLOPE HAS TEMPORARILY OR PERMANENTLY CEASED.
- MITIGATION MEASURES FOR DUST CONTROL SHALL BE IN PLACE DURING CONSTRUCTION TO PREVENT FUGITIVE PARTICULATE EMISSIONS FROM REACHING EXISTING ROADS AND NEIGHBORING PROPERTIES.

DEVELOPMENT PLAN NOTES:

- PROPOSED SITE SHALL BE IN COMPLIANCE WITH CHAPTER 4.9.3 OF THE LAND DEVELOPMENT CODE (LDC). SURVEY COMPLETED BY WILKINSON MANAGEMENT GROUP, PLLC ON OCTOBER 18, 2017.
- PROPOSED BUILDING SHALL BE IN COMPLIANCE WITH CHAPTER 5.5.2 OF THE LDC.
- REQUESTING WAIVER FOR 10' VEHICULAR USE AREA BUFFER ADJACENT TO PRIVATE ACCESS EASEMENT PER LDC SECTION 10.2.10.
- REQUESTING WAIVER FOR INTERIOR LANDSCAPE AREAS TO REMAIN AS PRESENTED ON PLAN PER LDC SECTION 10.2.12.
- REQUESTING WAIVER FOR ENCRoACHMENT OF VEHICLE MANEUVERING AREA INTO 25' SCENIC CORRIDOR BUFFER PER LDC SECTION 10.3.6.

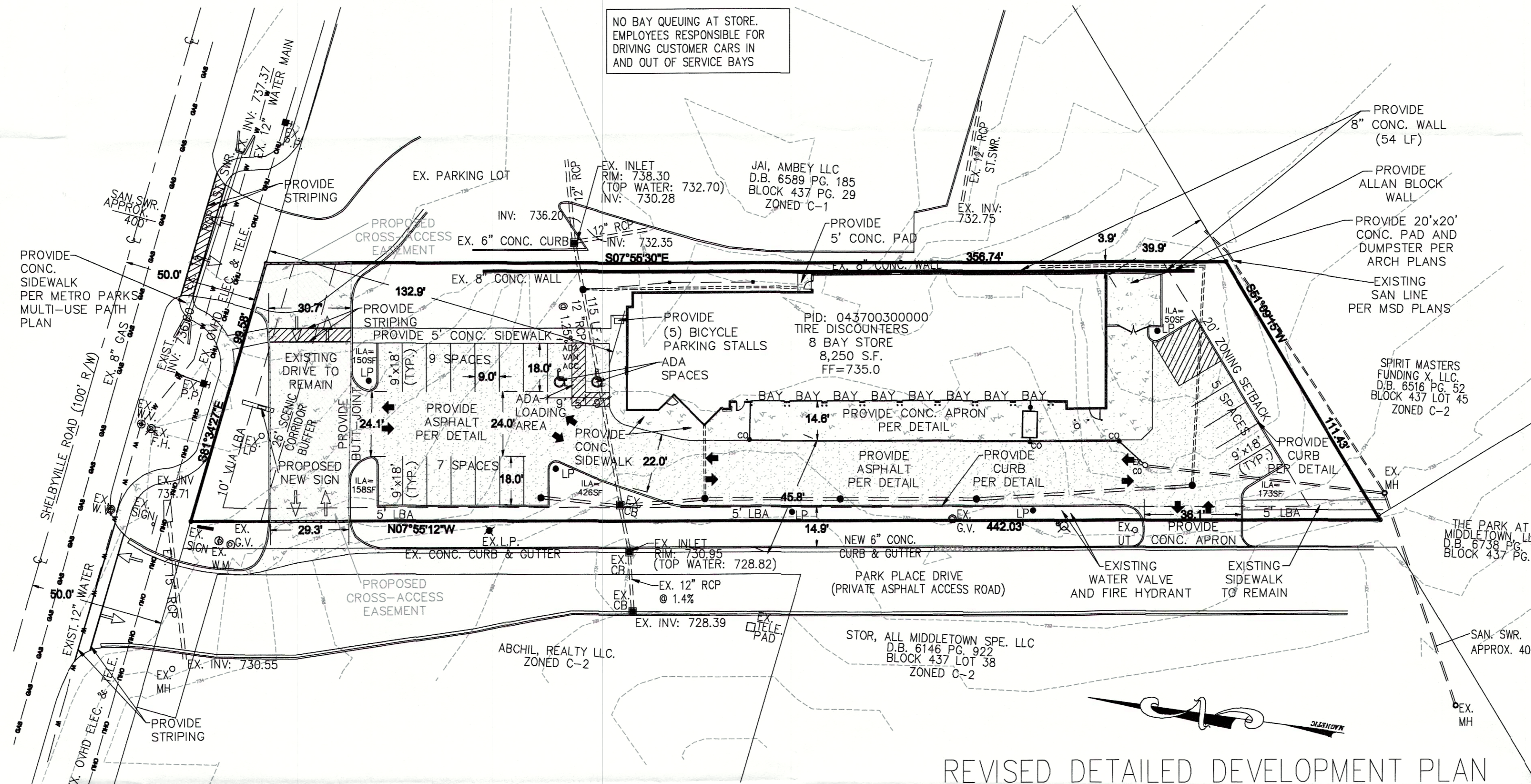

REVISED DETAILED DEVELOPMENT PLAN

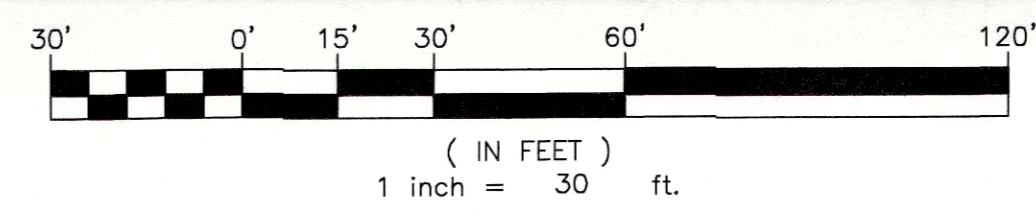

LINE TYPE LEGEND

---	= PROPERTY LINE
- - - - -	= EXISTING CONTOUR
---	= STORM SEWER PIPE
---	= SANITARY SEWER PIPE
---	= LANDSCAPE BUFFER
---	= OVERHEAD UTILITY LINE
---	= GAS LINE
---	= WATER LINE

LEGEND

■	= POWER POLE (PP)
⊗	= FIRE HYDRANT
■	= CATCH BASIN
○	= MANHOLE
○	= UTILITY POLE
●	= LIGHT POLE
○	= CLEAN-OUT
○	= GAS VALVE
○	= WATER METER
⊗	= WATER VALVE

WM#5903
PREVIOUS CASE #9-12-90

NO.	DESCRIPTION	DATE
10-18-17	MDC	BY
10-2-17	MDC	BY
10-2-17	MDC	BY

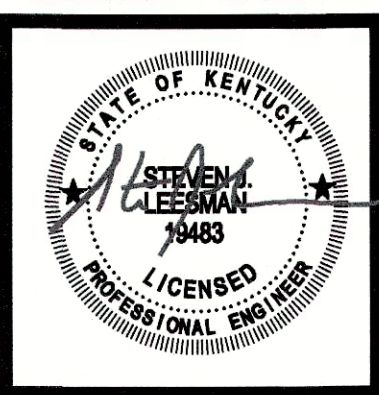

TIRE DISCOUNTERS
MIDDLETOWN
13200 SHELBYVILLE RD, LOUISVILLE, KENTUCKY 40223

LEESMAN ENGINEERING & ASSOC.
ENGINEERING, SURVEYING, PLANNING
2720 TOPIC HILLS, CINCINNATI, OHIO 45248 513-417-0420

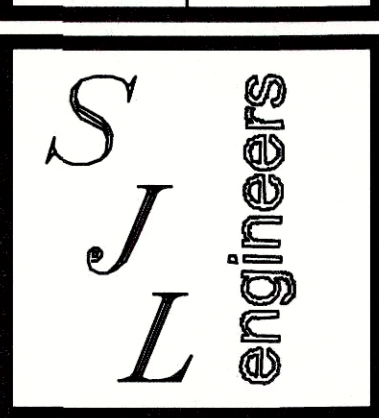

DRAWING TITLE

REVISED
DDP

PROJ. NO.	DATE
TD-SHELB	8-28-17
DRAWN	CHECKED
TMD	SJL

DRAWING NO.

DDP