

REZONING PARCEL 1
 EXISTING FORM DISTRICT SMC, NEIGHBORHOOD
 EXISTING ZONE R-4
 PROPOSED ZONE C-M
 EXISTING USE VACANT
 PROPOSED USE WAREHOUSE
 PROP. BUILDING S.F. 7,500 SQ. FT.
 PROP SITE ACREAGE 15,373 SQ. FT.

REZONING PARCEL 2
 EXISTING FORM DISTRICT SMC
 EXISTING ZONE C-1, R-4
 PROPOSED ZONE C-1
 EXISTING USE PARKING LOT
 PROPOSED USE PARKING LOT
 PROP SITE ACREAGE 13,127 SQ. FT.

PARKING SUMMARY - PARCEL 2 + 8319 PRESTON OFFICE
 MED OFFICE SQUARE FOOTAGE-9856 SQ FT
 MINIMUM PARKING (1/250 SQ FT.) 39 SPACES
 MAXIMUM PARKING (1/500 SQ FT) 66 SPACES
 PROVIDED PARKING 56 SPACES

TREE CANOPY PARCEL 1 AND 2

TOTAL SITE AREA: 28,500 SQ.FT.±
 EXISTING TREE CANOPY: 0 SQ.FT.±
 REQUIRED TREE CANOPY: 2,850 SQ.FT.± 1/2 of required 20%=(10%)
 PROPOSED TREE CANOPY: 3,264 SQ. FT.
 (1 PROPOSED PROPOSED TYPE A AT 3'-10" 960 SQ. FT. = 960 SQ. FT.)
 (4 PROPOSED PROPOSED TYPE B AT 3'-10" 576 SQ. FT. = 2304 SQ. FT.)
 TOTAL TREE CANOPY PROVIDED 3264 SQ. FT.± (11.45%)

TOTAL PROJECT SUMMARY - RDDP FOR SCHELLERS WITH PARCEL 1
 EXISTING FORM DISTRICT SMC, NEIGHBORHOOD
 EXISTING ZONE C-M, R-4
 PROPOSED ZONE C-M, SMC
 EXISTING USE RETAIL, VACANT (REAR)
 PROPOSED USE RETAIL AND WAREHOUSE
 EXISTING BUILDING S.F. 36,482± SQ. FT.
 RETAIL 12,038± SQ. FT.
 EX. WAREHOUSE 21,394± SQ. FT.
 PROP. BUILDING S.F. 7,500± SQ. FT.
 TOTAL WAREHOUSE 28,894± SQ. FT.
 INCREASE IN S.F. 26%
 SITE ACREAGE 2.77 AC.±
 LOT AREA 125,315± SQ. FT.

PARKING SUMMARY - RETAIL (FURNITURE) BLDG 1
 [RETAIL SQUARE FOOTAGE - 12,038 SQ FT]
 MINIMUM PARKING (1/400 SF) 30 SPACES
 MAXIMUM PARKING (1/200 SF) 60 SPACES
 PROVIDED PARKING 32 SPACES

PARKING SUMMARY - WAREHOUSE 28 EMP.-BLDG 2, 3 & 4
 MINIMUM PARKING (1/1.5 EMP.) 19 SPACES
 MAXIMUM PARKING (1/1 EMP.) 28 SPACES
 PROVIDED PARKING 28 SPACES

SCHELLER PARKING SUMMARY - COMBINED WITH PARCEL 1
 MINIMUM PARKING 46 SPACES
 MAXIMUM PARKING 88 SPACES
 EX. PARKING 55 SPACES
 PROPOSED PARKING 7 SPACES
 PROVIDED PARKING 61 SPACES (4 H/C)
 EX. V.U.A. 29,818 SQ. FT.±
 PROP. V.U.A. 2,908 SQ. FT.±
 NEW TOTAL V.U.A. 32,726 SQ. FT.±
 I.L.A. REQUIRED 2,416 SQ. FT. (7.5%)
 I.L.A. PROVIDED 3,131 SQ. FT.±
 TYP. EXISTING PARKING SPACE 9' X 18'
 TYP. PROPOSED PARKING SPACE 10' X 18'

SHORT TERM BICYCLE 4 EXISTING BIKE RACK
 LONG TERM BICYCLE 4 LOCATE INSIDE WAREHOUSE

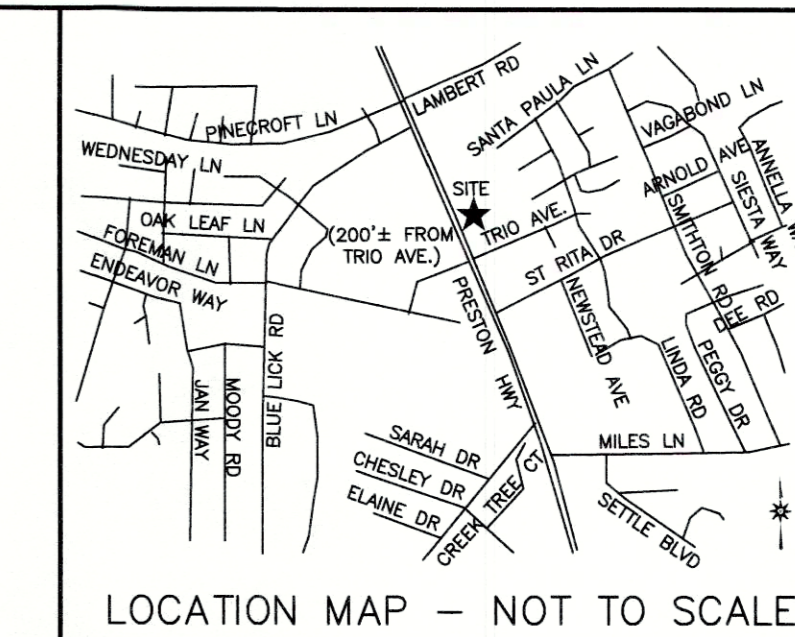

REVISIONS	
NO.	DESCRIPTION
1	REV. PER AGENCY COMMENTS
2	REV. PER AGENCY COMMENTS
3	REV. PER AGENCY COMMENTS
4	REV. PER AGENCY COMMENTS
5	REV. PER AGENCY COMMENTS

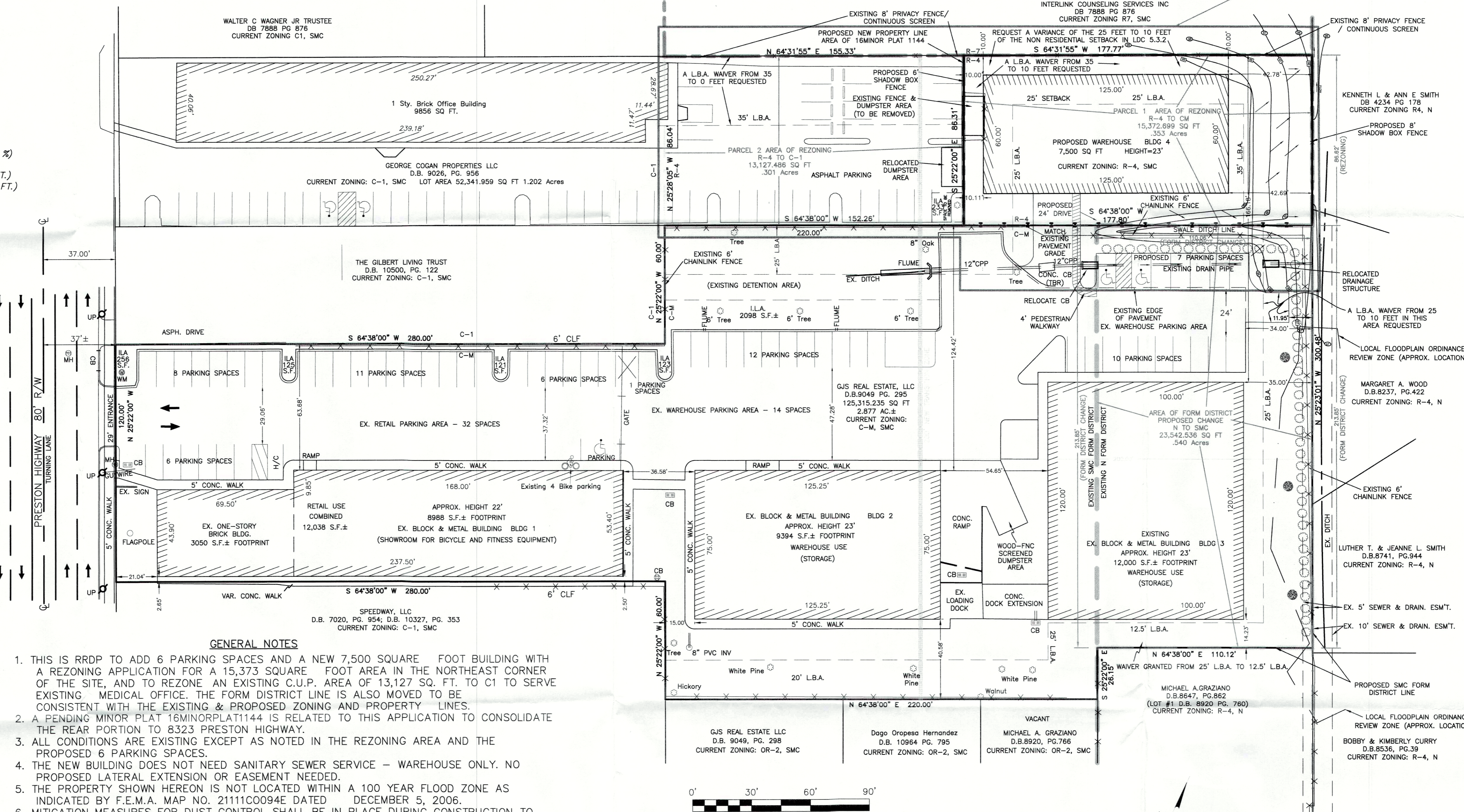
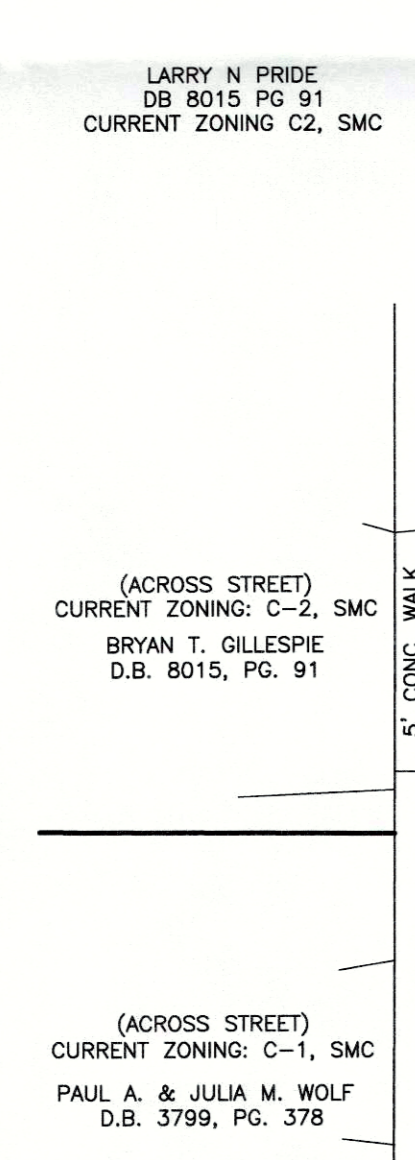
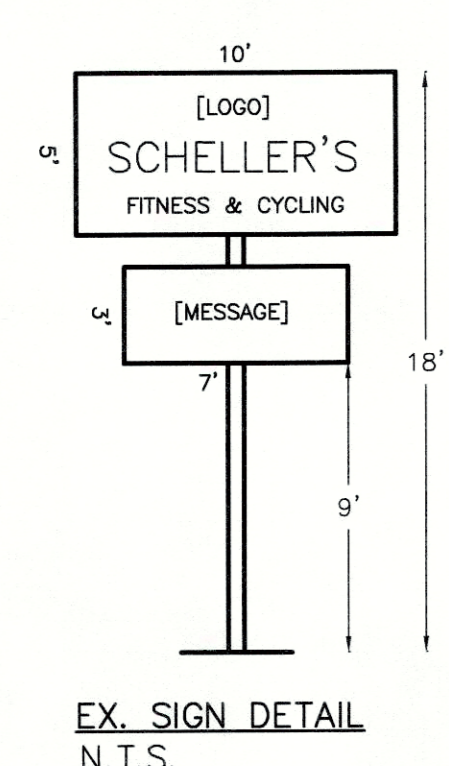

- WAIVER AND VARIANCE REQUESTS**
1. A L.B.A. WAIVER FROM 35 TO 10 FEET IS REQUESTED ON THE NORTH AND WEST SIDE OF AREA OF PARCEL 1 TO BE REZONED.
 2. A L.B.A. WAIVER FROM 35 TO 0 FEET IS REQUESTED ON THE NORTH SIDE OF AREA OF PARCEL 2 TO BE REZONED BASED ON EXISTING CONDITIONS.
 3. A VARIANCE FROM LDC 5.3.2 REQUIRING A 30 FOOT BUILDING SETBACK FROM NON RESIDENTIAL TO RESIDENTIAL PROPERTY TO A 10 FOOT SETBACK AS SHOWN ON THE PLAN.
 4. A LBA WAIVER FROM 25 TO 10 FEET LBA ON THE EAST SIDE WHERE INDICATED TO ALLOW FOR A TURNING AREA.

- GENERAL NOTES**
1. THIS IS RDDP TO ADD 6 PARKING SPACES AND A NEW 7,500 SQUARE FOOT BUILDING WITH A REZONING APPLICATION FOR A 15,373 SQUARE FOOT AREA IN THE NORTHEAST CORNER OF THE SITE, AND TO REZONE AN EXISTING C.U.P. AREA OF 13,127 SQ. FT. TO C1 TO SERVE EXISTING MEDICAL OFFICE. THE FORM DISTRICT LINE IS ALSO MOVED TO BE CONSISTENT WITH THE EXISTING & PROPOSED ZONING AND PROPERTY LINES.
 2. A PENDING MINOR PLAT 16MINORPLAT1144 IS RELATED TO THIS APPLICATION TO CONSOLIDATE THE REAR PORTION TO 8323 PRESTON HIGHWAY.
 3. ALL CONDITIONS ARE EXISTING EXCEPT AS NOTED IN THE REZONING AREA AND THE PROPOSED 6 PARKING SPACES.
 4. THE NEW BUILDING DOES NOT NEED SANITARY SEWER SERVICE - WAREHOUSE ONLY. NO PROPOSED LATERAL EXTENSION OR EASEMENT NEEDED.
 5. THE PROPERTY SHOWN HEREON IS NOT LOCATED WITHIN A 100 YEAR FLOOD ZONE AS INDICATED BY F.E.M.A. MAP NO. 21111C0094E DATED DECEMBER 5, 2006.
 6. MITIGATION MEASURES FOR DUST CONTROL SHALL BE IN PLACE DURING CONSTRUCTION TO PREVENT FUGITIVE PARTICULATE EMISSIONS FROM REACHING EXISTING ROADS & NEIGHBORING PROPERTIES.
 7. MSD DRAINAGE BOND REQUIRED PRIOR TO CONSTRUCTION PLAN APPROVAL.
 8. LOUISVILLE METRO BOARD OF HEALTH APPROVAL REQUIRED PRIOR TO MSD CONSTRUCTION PLAN APPROVAL.
 9. A KARST STUDY WAS PERFORMED BY MARK STITES ON MAY 8, 2018, AND NO KARST FEATURES WERE IDENTIFIED.
 10. NO WORK TO BE PERFORMED IN PUBLIC RIGHT OF WAY AND REQUEST WAIVERS IF ANY RIGHT OF WAY DEDICATION REQUIRED PER LDC BASED ON LOCATION OF PROJECT.
 11. SITE IS SUBJECT TO REGIONAL FACILITY FEE OF X 1.5.
 12. IF SITE HAS THRU DRAINAGE AND EASEMENT PLAT WILL BE REQUIRED PRIOR TO MSD GRANTING CONSTRUCTION PLAN APPROVAL.

- MSD NOTES**
1. NO SANITARY SEWER SERVICE WILL BE PROVIDED. TO THE NEW 7500 SQ. FT. BUILDING.
 2. NO PORTION OF THE SITE IS WITHIN THE 100 YEAR FLOOD PLAIN
 3. DRAINAGE PATTERN DEPICTED BY ARROWS IS FOR CONCEPTUAL PURPOSES. FINAL CONFIGURATION AND SIZE OF DRAINAGE PIPES AND CHANNELS SHALL BE DETERMINED DURING THE CONSTRUCTION PLAN DESIGN PROCESS. DRAINAGE FACILITIES SHALL CONFORM TO MSD REQUIREMENTS.
 4. IF THE SITE HAS THRU DRAINAGE AN EASEMENT PLAT WILL BE REQUIRED PRIOR TO MSD GRANTING CONSTRUCTION PLAN APPROVAL.
 5. EROSION & SIT CONTROL SHOWN IS CONCEPTUAL ONLY AND FINAL DESIGN WILL BE DETERMINED ON CONSTRUCTION PLANS. PRIOR TO ANY CONSTRUCTION ACTIVITIES ON THE SITE A EROSION & SILT CONTROL PLAN SHALL BE PROVIDED TO MSD FOR APPROVAL.

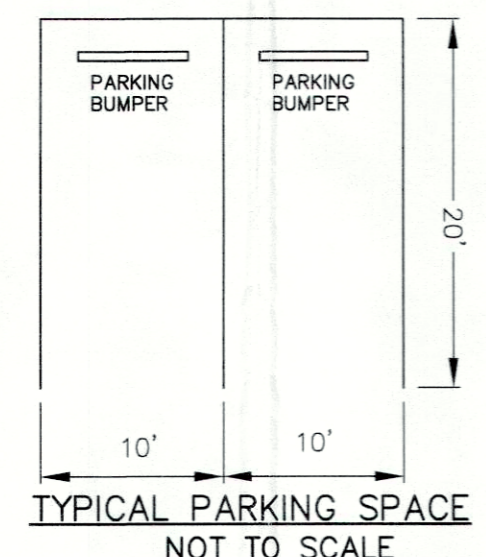
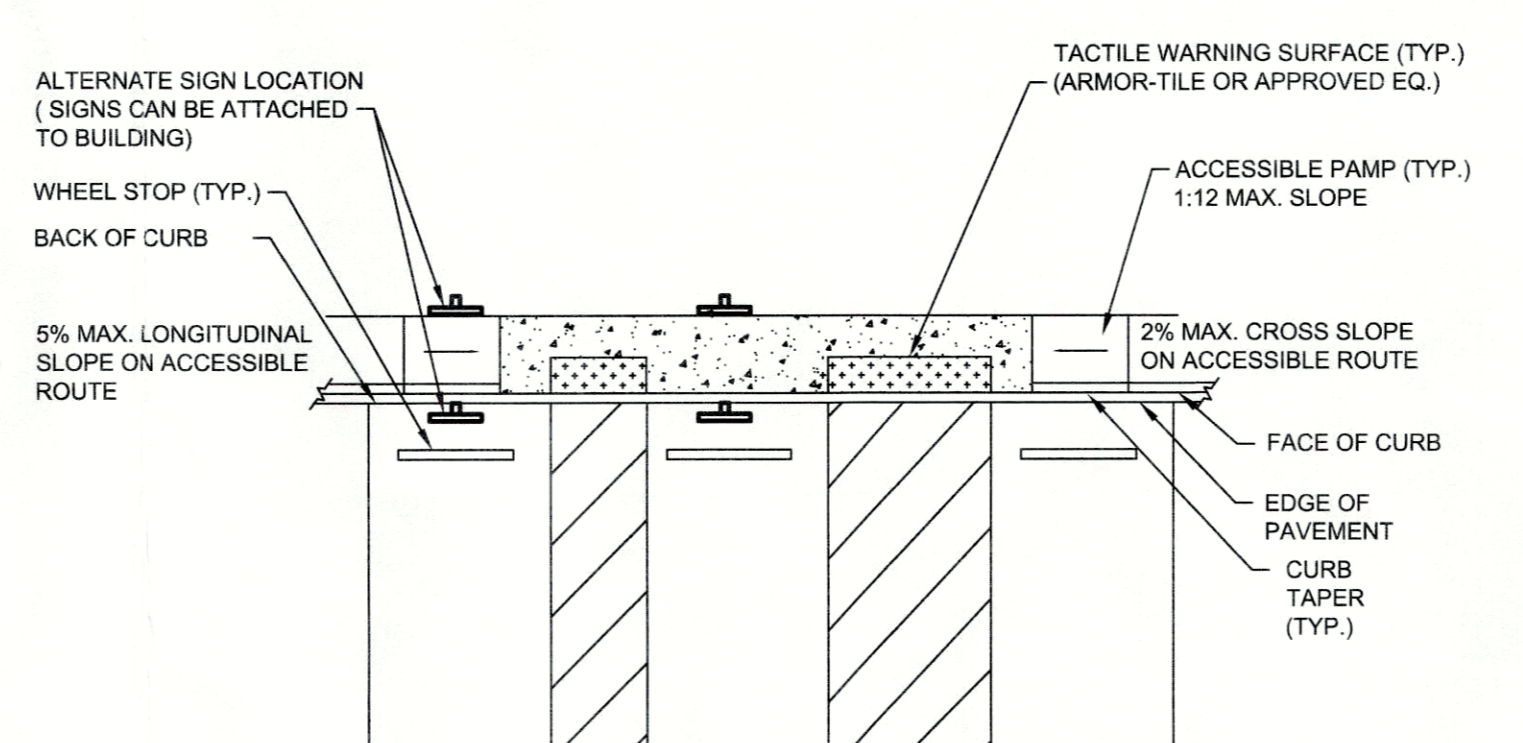
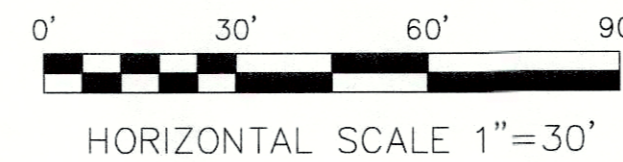
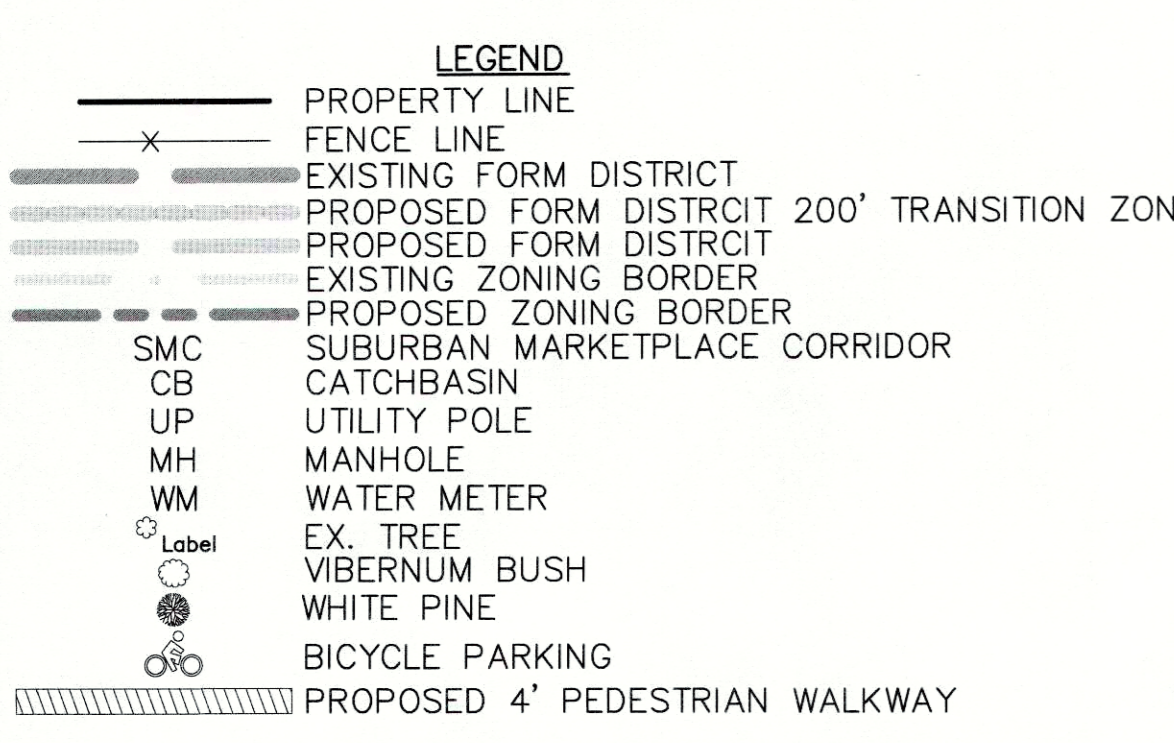

CURRENT PROPERTY OWNER
 8319 PRESTON HIGHWAY
 LOUISVILLE, KY 40219
 GEORGE COGAN PROPERTIES, LLC
 8319 PRESTON HIGHWAY
 LOUISVILLE, KY 40219
 D.B. 9026, PG. 956; PARCEL ID 065100410000

CURRENT PROPERTY OWNER
 8323 PRESTON HIGHWAY
 LOUISVILLE, KY 40219
 GJS REAL ESTATE, LLC
 709 HOLLINGSWORTH PLACE
 LOUISVILLE, KY 40207
 D.B. 9049, PG. 295; PARCEL ID 065100450000

DOCKET # 17ZONE1067
 REVISED DETAIL DISTRICT DEVELOPMENT PLAN
 PREVIOUS DOCKET NO. 8740/9856
 ORIGINAL PLAN DATE: 10/20/17
 WM # 222

CARDINAL PLANNING & DESIGN, INC.
 9009 PRESTON HWY.
 LOUISVILLE, KY 40219
 (502) 969-2788
 FAX: (502) 968-7077
 info@cardinalplanning.com

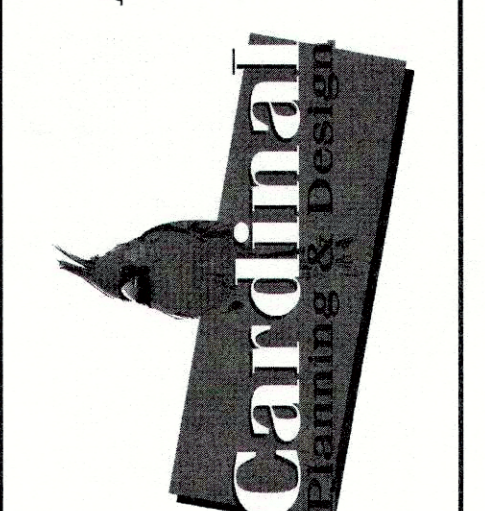

REZONING APPL. AND REVISED DETAIL DISTRICT DEVELOPMENT PLAN

SCHELLER'S FITNESS & CYCLING
 8323 & 8319 REAR PRESTON HWY
 LOUISVILLE, KY 40219

17ZONE1067