

**EXHIBITS FOR APPLICANT  
Zaremba Group, LLC  
9267 Smyrna Parkway**

**Louisville Metro Planning Commission  
Case No. 16 Zone 1005**

- 1) Zoning Map
- 2) Site Photography
- 3) Rendering
- 4) Elevations
- 5) Development Plan
- 6) Variance Justification
- 7) Waiver Justification
- 8) Zoning Change Demonstration of Appropriateness
- 9) Proposed Findings of Fact

**Erik Lattig  
Attorney for Applicant  
Frost Brown Todd LLC  
400 West Market Street, 32<sup>nd</sup> Floor  
Louisville, Kentucky 40202  
502/779-8511  
[elattig@fbtlaw.com](mailto:elattig@fbtlaw.com)**



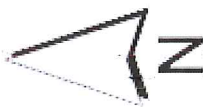
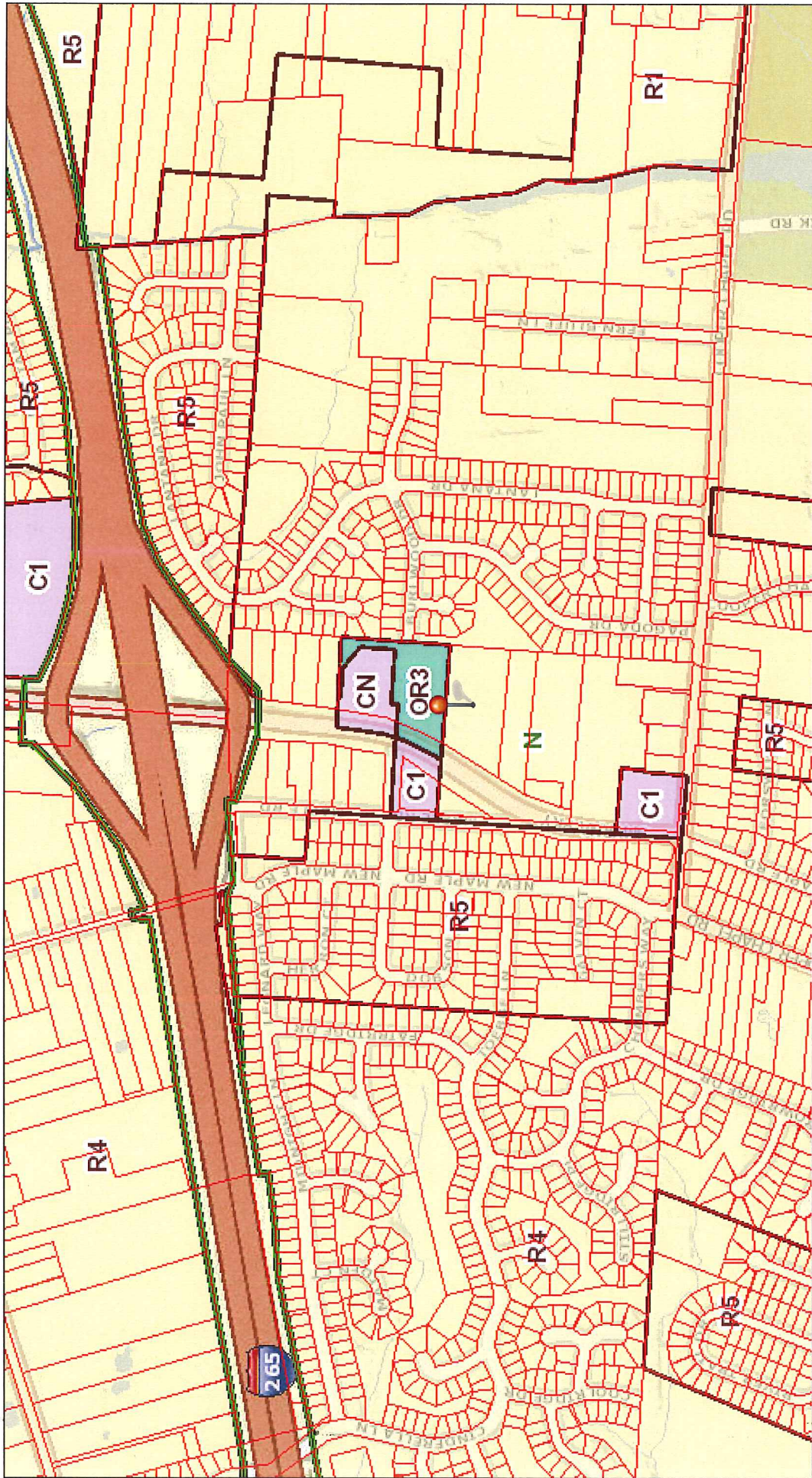

3/7/2016, 2:20:29 PM



Louisville Metro, MSD, LWC & PVA © 2016

This map is not a legal document and should only be used for general reference and identification.



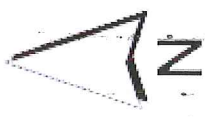
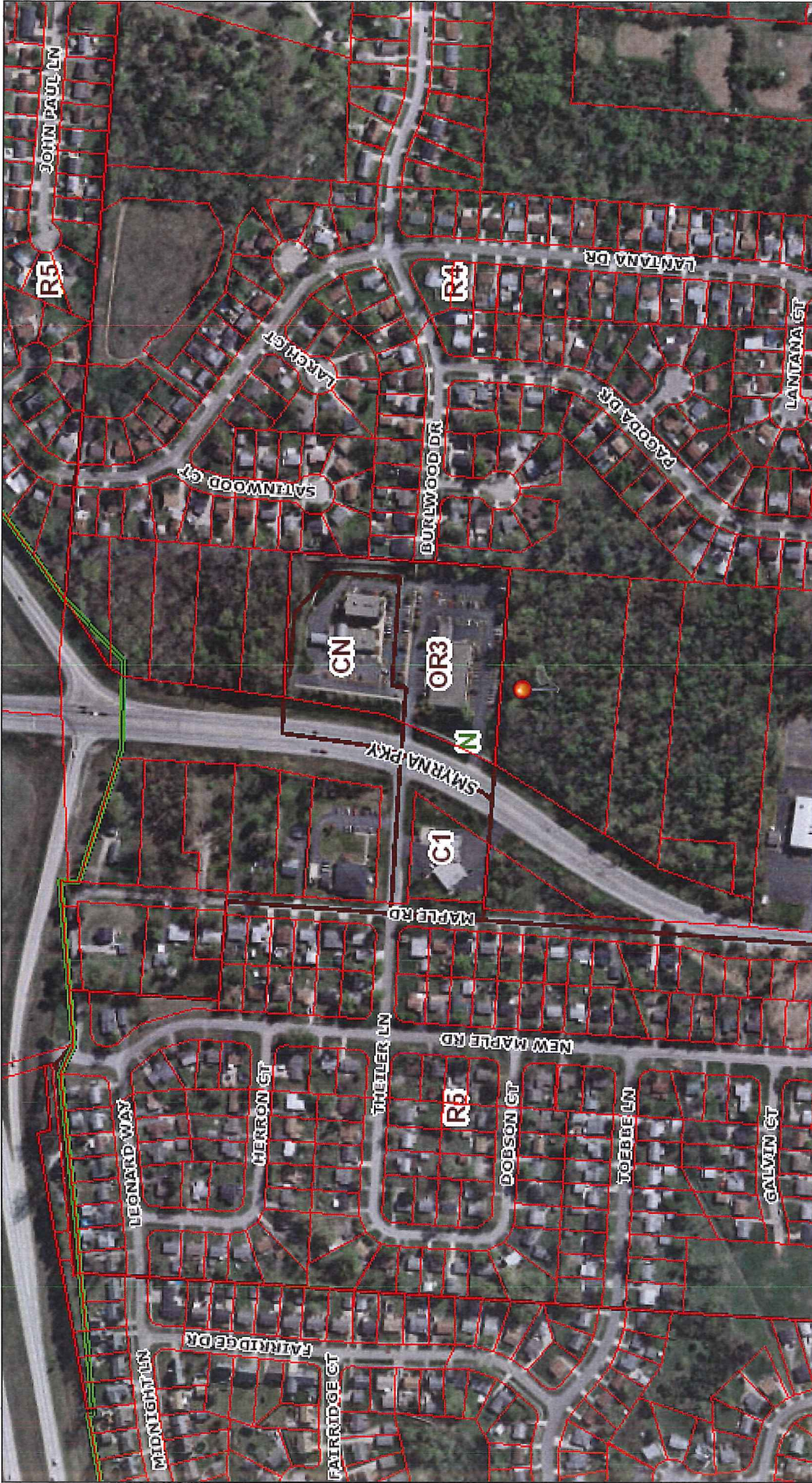

3/7/2016, 2:23:39 PM



Louisville Metro, MSD, LWC & PVA © 2016

This map is not a legal document and should only be used for general reference and identification.





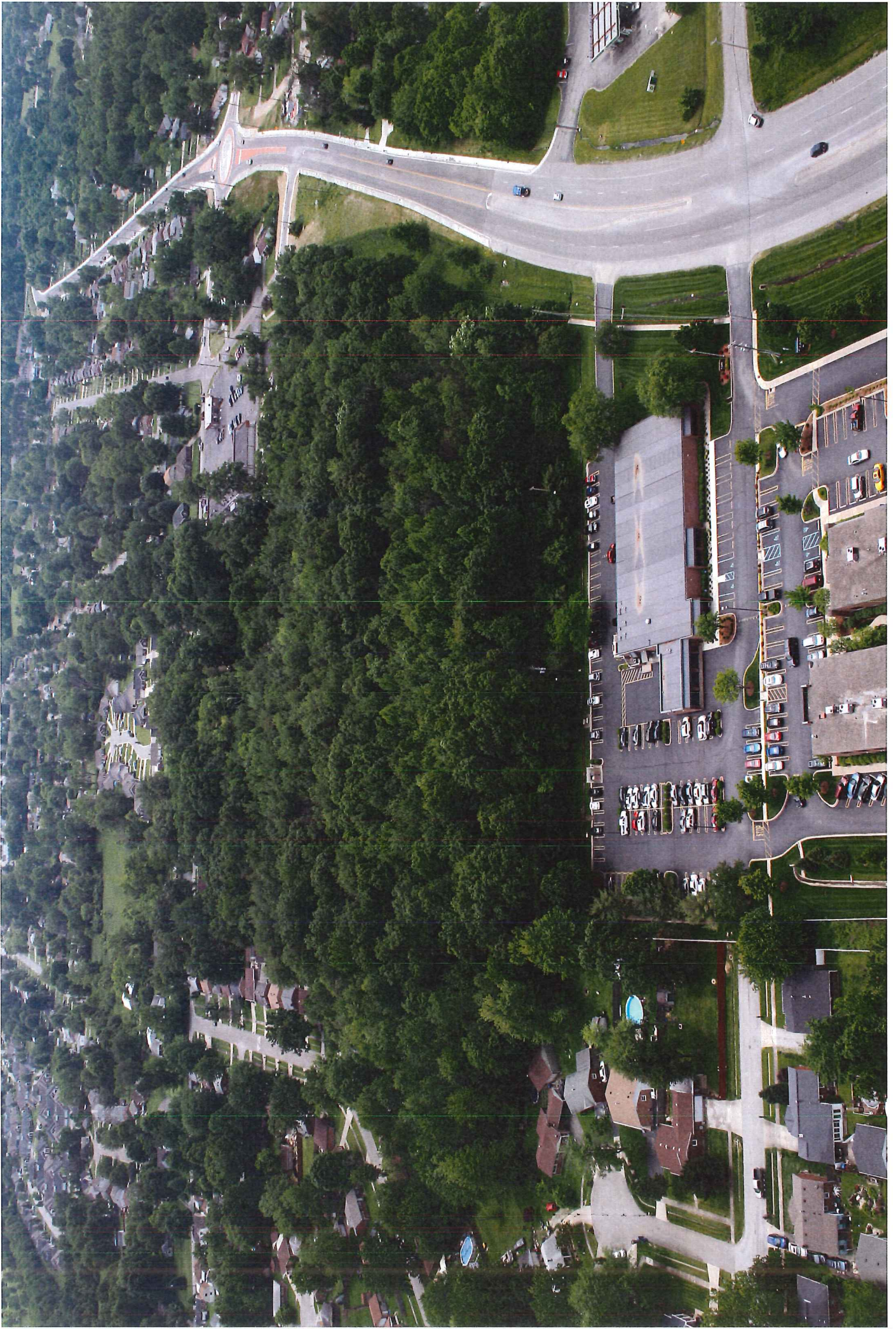







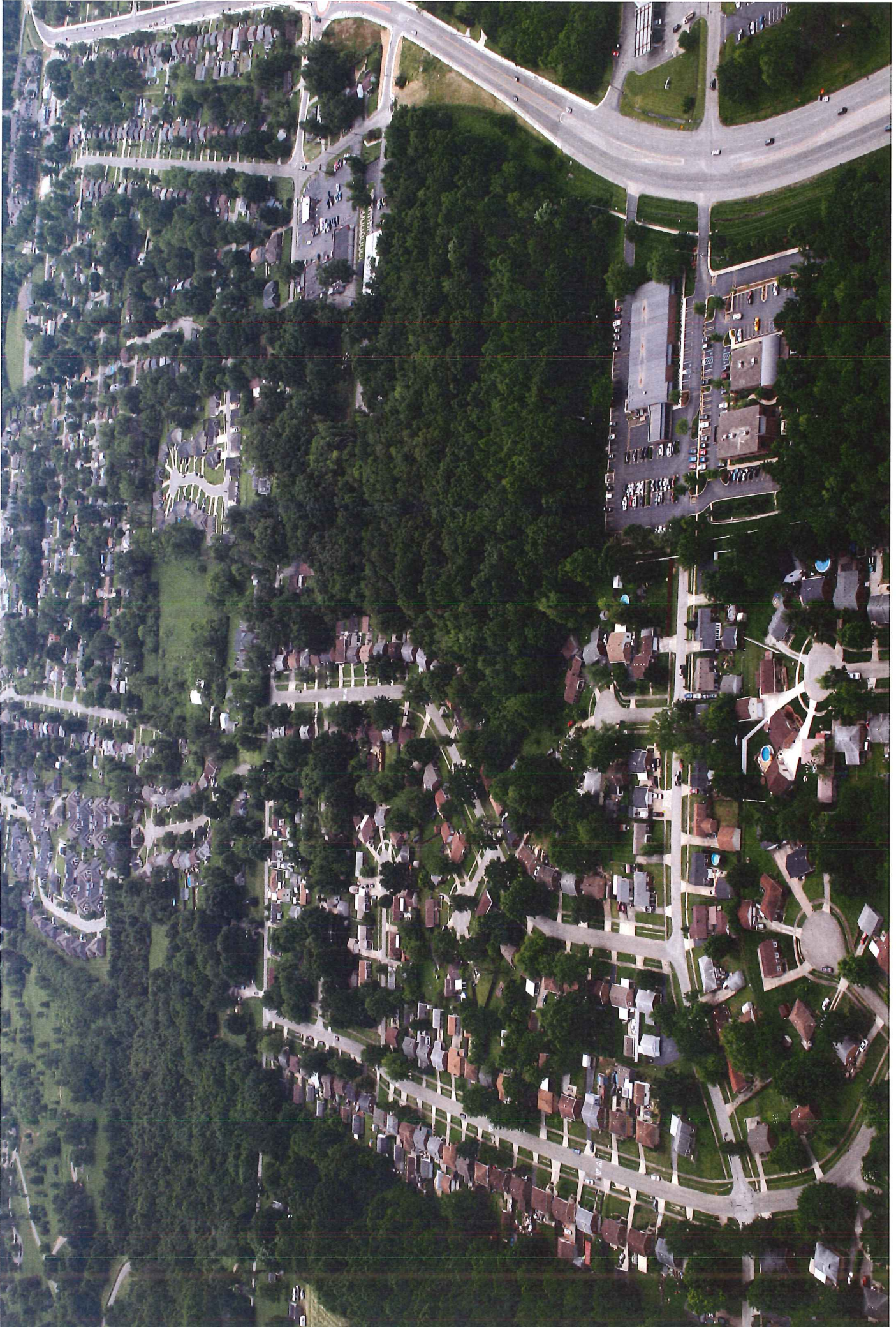







REVISIONS:	

Louisville, KY  
 502.581.1111

**DOLLAR GENERAL**

DATE: 05.02.2016  
 DRAWING TITLE: EXTERIOR ELEVATIONS  
 DRAWN BY - CHECKED BY: M.J.M ARCHITECTS  
 SHEET NO.

**A02**

**FLOOR PLAN KEYED NOTES**

- |                                                                                                                                                                                                                                                                                                                                                                                                                                                                                                                                                                                                                                                                                                                                                                                                                                                                                                                                                                                                                                      |                                                                                                                                                                                                                                                                                                                                                                                                                                                                                                                                                                                                                                                                                                                                                                                                                                                                                                                                                                                                                                                                                                                                                                        |                                                                                                                                                                                                                                                                                                                                                                                                                                                                                                                                                                                                                                                                                                                                                                                                                                                                                                                                                                                                                                                                                                                                                                                                                                                                           |
|--------------------------------------------------------------------------------------------------------------------------------------------------------------------------------------------------------------------------------------------------------------------------------------------------------------------------------------------------------------------------------------------------------------------------------------------------------------------------------------------------------------------------------------------------------------------------------------------------------------------------------------------------------------------------------------------------------------------------------------------------------------------------------------------------------------------------------------------------------------------------------------------------------------------------------------------------------------------------------------------------------------------------------------|------------------------------------------------------------------------------------------------------------------------------------------------------------------------------------------------------------------------------------------------------------------------------------------------------------------------------------------------------------------------------------------------------------------------------------------------------------------------------------------------------------------------------------------------------------------------------------------------------------------------------------------------------------------------------------------------------------------------------------------------------------------------------------------------------------------------------------------------------------------------------------------------------------------------------------------------------------------------------------------------------------------------------------------------------------------------------------------------------------------------------------------------------------------------|---------------------------------------------------------------------------------------------------------------------------------------------------------------------------------------------------------------------------------------------------------------------------------------------------------------------------------------------------------------------------------------------------------------------------------------------------------------------------------------------------------------------------------------------------------------------------------------------------------------------------------------------------------------------------------------------------------------------------------------------------------------------------------------------------------------------------------------------------------------------------------------------------------------------------------------------------------------------------------------------------------------------------------------------------------------------------------------------------------------------------------------------------------------------------------------------------------------------------------------------------------------------------|
| <p>1 RECEIVING DOOR BUZZER - TORK MDL.#TA725 OR EQUAL</p> <p>2 DOOR SCOPE, REFER TO T01 AND DOOR SCHEDULE.</p> <p>3 WEATHER STRIP &amp; LOW PROFILE THRESHOLD, REFER TO T01 AND DOOR SCHEDULE.</p> <p>4 STRIPE FLOOR FOR DESIGNATED EGRESS PATH (PAINT YELLOW) AND DESIGNATED EMS PANEL CLEARANCE (PAINT RED).</p> <p>4A STRIPE FLOOR FOR DESIGNATED ADA EGRESS PATH (PAINT YELLOW).</p> <p>5 PROVIDE AND INSTALL A TEN GALLON WATER HEATER (OR LARGER IF REQUIRED BY CODE) ABOVE THE MOP SINK.</p> <p>6 3 5/8" METAL STUD WITH 1/2" MINIMUM GYPSUM BOARD (BOTH SIDES). REFER TO NOTED WALL SECTION. REFER TO ROOM FINISH SCHEDULE FOR GYPSUM BOARD HEIGHT AT ANY PARTICULAR WALL.</p> <p>7 METAL LINER PANELS TO 8'-0" A.F.F. AT RECEIVING AREA. (BY PRE-ENGINEERED BUILDING MANUFACTURER).</p> <p>8 NOT USED.</p> <p>9 BRICK NICHIA PANELS</p> <p>10 CONCRETE SLAB WITH 6X6XW1.4 WELDED WIRE MESH OVER POLYETHYLENE VAPOR BARRIER (MIN. 10 MM THICK) OVER CRUSHED STONE BASE, TYPICAL. PROVIDE CONTROL JOINTS AS SHOWN ON S03.</p> | <p>11 METAL BUILDING FRAME. REFER TO NOTED WALL SECTION FOR ADDITIONAL INFORMATION.</p> <p>12 1/2" MIN GYPSUM BOARD (TOP @ 10'-0" A.F.F.) OVER METAL LINER PANELS AND INSULATION WITH VAPOR BARRIER. REFER TO INTERIOR SALES AREA ELEVATIONS.</p> <p>13A SMOOTH, ECONOMY SIZED BRICK WAINSCOT, PAINTED. SEE ELEVATIONS FOR SPECIFIED COLOR. REFER TO WALL SECTION FOR ADDITIONAL INFORMATION.</p> <p>13B SMOOTH, ECONOMY SIZED BRICK VENEER ON METAL STUDS, PAINTED. SEE ELEVATIONS FOR SPECIFIED COLOR. REFER TO WALL SECTION FOR ADDITIONAL INFORMATION.</p> <p>14 SLOPE CONCRETE 1/8" PER FOOT AWAY FROM BUILDING.</p> <p>15 BROOM FINISH CONCRETE SIDEWALK, TYPICAL.</p> <p>16 BRONZE STOREFRONT SYSTEM. REFER TO NOTED WALL SECTION FOR ADDITIONAL INFORMATION.</p> <p>17 LINE OF METAL AWNING ABOVE (BY PEMB). REFER TO REFLECTED CEILING PLAN AND NOTED SECTION.</p> <p>18 A.D.A. COMPLIANT ACCESSIBLE RAMP WITH YELLOW PAINTED SIDES TO ACCESSIBLE PARKING STALLS.</p> <p>19 MC CUE CART AND BUMPER GUARDS. TOP INSTALLED @ 3'-5" A.F.F. ORDER TRIM KIT FOR THIS PROTOTYPE.</p> <p>20 WALL HYDRANT. REFER TO PLUMBING DRAWINGS FOR ADDITIONAL INFORMATION.</p> | <p>21 REFRIGERATION BY DOLLAR GENERAL.</p> <p>22 STEEL COLUMN, ROUND (BY PEMB) WITH RECESSED BASE-PLATE. PAINT SW7005 PURE WHITE. WRAP STEEL COLUMN WITH TIGHT LOOP CARPET (BLACK) FROM BASE TO 48" A.F.F.</p> <p>23 POWER POLE. COORDINATE FINAL LOCATION WITH ELECTRICAL DRAWINGS AND FINAL DOLLAR GENERAL FIXTURE PLAN (F01).</p> <p>24 CONTROL JOINTS ARE TO BE PLACED ALONG COLUMN LINES AND DIVIDING COLUMN BAYS AS INDICATED. COORDINATE WITH STRUCTURAL DRAWINGS.</p> <p>25 FLOOR AREA AT BASE OF COLUMNS, WITHIN THE CONSTRUCTION JOINTS, TO BE PAINTED BLACK MAGIC TINT.</p> <p>26 ALTERNATE LOCATION FOR DELIVERY DOORS. MOVE ELECTRICAL EQUIPMENT TO OTHER WALL.</p> <p>27 METAL STUD PARTITION. REFER TO ENLARGED VESTIBULE PLAN, 1/A03.2, FOR ADDITIONAL INFORMATION.</p> <p>28 CART AREA, REFER TO 5 &amp; 6/A06 FOR ADDITIONAL DETAILS.</p> <p>29 ENDCAP COOLER/FREEZER TO BE HARDWIRED THROUGH SO CORD WITH DUPLEX AT END. GC TO LEAVE BOTTOM OF CORD HANGING AT 80" A.F.F. (SEE ELECTRICAL). SO CORD TO BE ANCHORED TO PURLINS ABOVE. COORDINATE LOCATION WITH FINAL DOLLAR GENERAL FIXTURE PLAN.</p> <p>30 MC CUE RAILING IN FRONT OF ELECTRICAL PANEL. 8'-0" LONG WITH TWO TOP RAILINGS AND NO MIDDLE POST.</p> <p>31 DECORATIVE NON VISUAL GLASS</p> |
|--------------------------------------------------------------------------------------------------------------------------------------------------------------------------------------------------------------------------------------------------------------------------------------------------------------------------------------------------------------------------------------------------------------------------------------------------------------------------------------------------------------------------------------------------------------------------------------------------------------------------------------------------------------------------------------------------------------------------------------------------------------------------------------------------------------------------------------------------------------------------------------------------------------------------------------------------------------------------------------------------------------------------------------|------------------------------------------------------------------------------------------------------------------------------------------------------------------------------------------------------------------------------------------------------------------------------------------------------------------------------------------------------------------------------------------------------------------------------------------------------------------------------------------------------------------------------------------------------------------------------------------------------------------------------------------------------------------------------------------------------------------------------------------------------------------------------------------------------------------------------------------------------------------------------------------------------------------------------------------------------------------------------------------------------------------------------------------------------------------------------------------------------------------------------------------------------------------------|---------------------------------------------------------------------------------------------------------------------------------------------------------------------------------------------------------------------------------------------------------------------------------------------------------------------------------------------------------------------------------------------------------------------------------------------------------------------------------------------------------------------------------------------------------------------------------------------------------------------------------------------------------------------------------------------------------------------------------------------------------------------------------------------------------------------------------------------------------------------------------------------------------------------------------------------------------------------------------------------------------------------------------------------------------------------------------------------------------------------------------------------------------------------------------------------------------------------------------------------------------------------------|

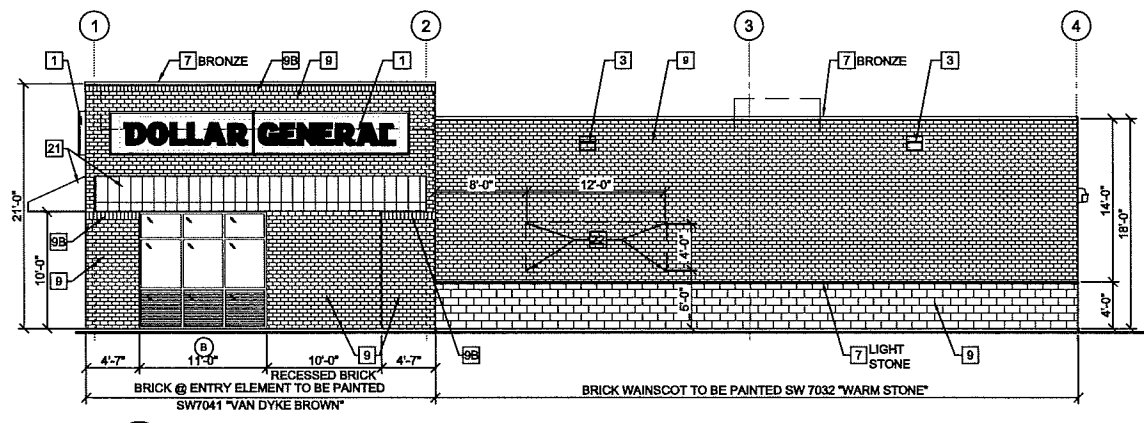

1-LH  
 A02  
**FRONT ELEVATION**  
 SCALE: NTS (1/8"=1'-0")

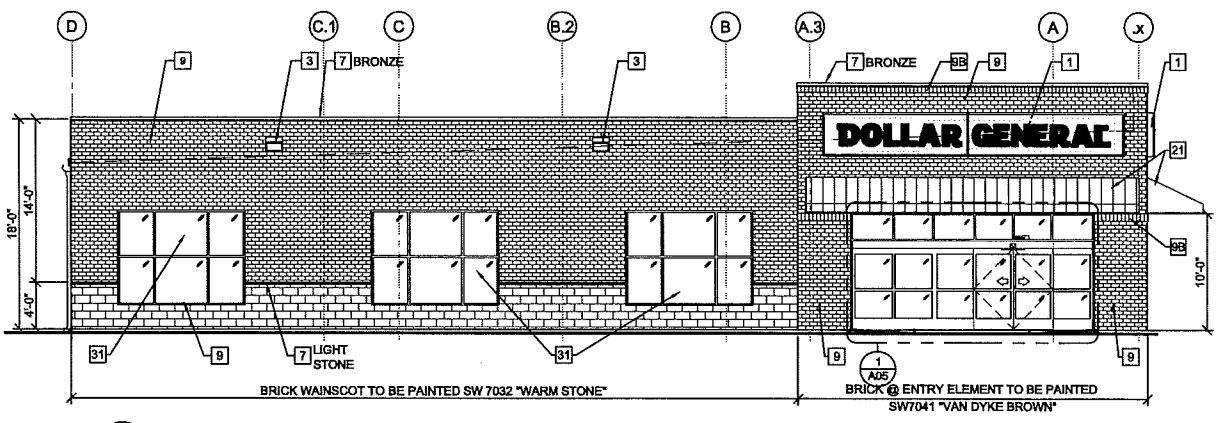

3-LH  
 A02  
**LEFT SIDE ELEVATION**  
 SCALE: NTS (1/8"=1'-0")

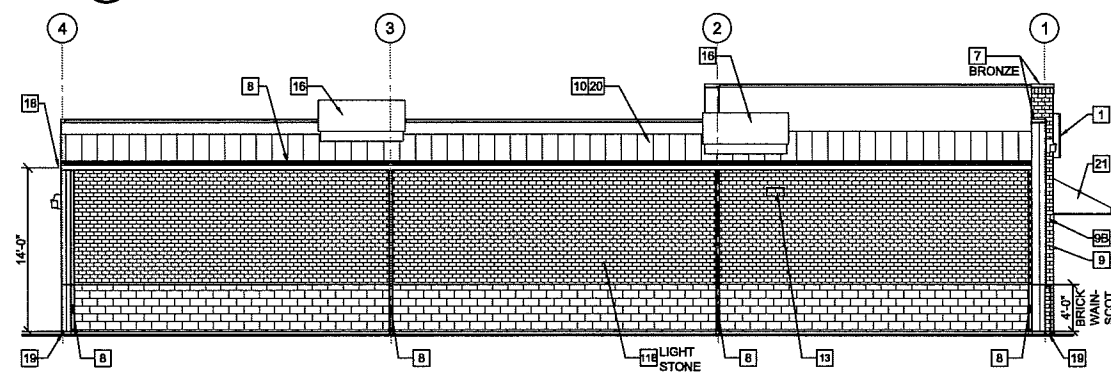

2-LH  
 A02  
**REAR ELEVATION**  
 SCALE: NTS (1/8"=1'-0")

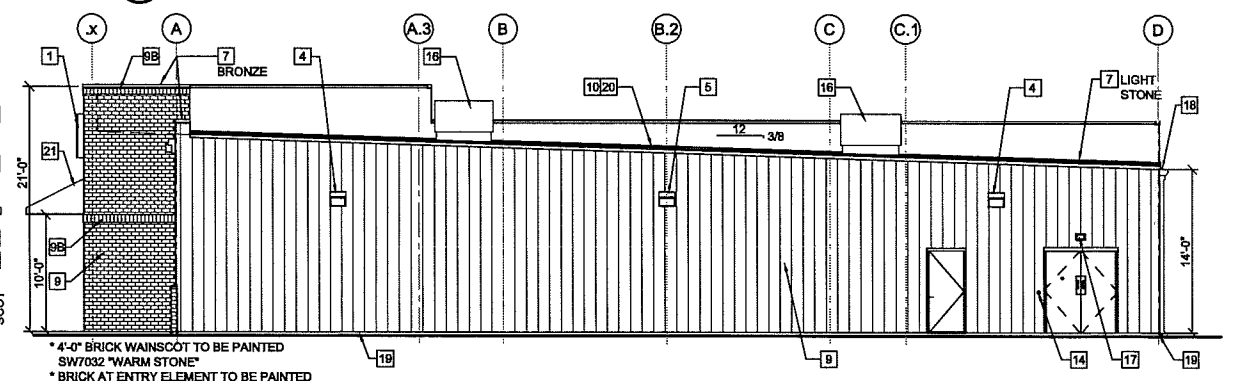

4-LH  
 A02  
**RIGHT SIDE ELEVATION**  
 SCALE: NTS (1/8"=1'-0")





**LEGEND**

- = OVERHEAD UTILITIES
- = EXISTING TREE LINE
- = TREE CANOPY TO BE PRESERVED IN TOPA
- = GUY POLE
- = LIGHT POLE
- = DRAINAGE SWALE
- = PROPOSED DRAINAGE SWALE
- = CONCRETE DRAINAGE SWALE
- = STORM SEWER OUTLET
- = STORM SEWER PIPE
- = PROPOSED STORM SEWER PIPE
- = PROPOSED DIRECTION OF FLOW
- = STONE BAG CHECK DAM (MSD DWG. EF-12-02)
- = TEMPORARY GRAVEL CONSTRUCTION ENTRANCE (MSD DWG. ER-01-03)
- = REINFORCED SILT FENCE (MSD EF-10-02)

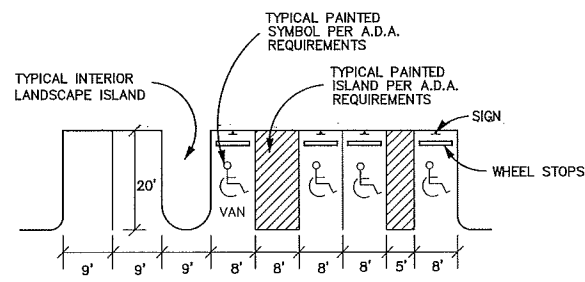

TYPICAL PARKING DETAIL

NO SCALE

**GENERAL NOTES**

1. SEWER AVAILABLE BY LATERAL EXTENSION.
2. DRAINAGE PATTERN DEPICTED BY ARROWS (→) IS TO CONCEPT PURPOSES ONLY. FINAL CONFIGURATION AND DESIGN OF DRAINAGE PIPES & CHANNELS SHALL BE DETERMINED DURING THE CONSTRUCTION PROCESS. DRAINAGE FACILITIES SHALL CONFORM TO MSD REQUIREMENTS.
3. BOUNDARY AND TOPOGRAPHIC INFORMATION TAKEN FROM SURVEY BY BTM ENGINEERING, INC.
4. AN APPROVED EROSION PREVENTION AND SEDIMENT CONTROL (EPSC) PLAN SHALL BE IMPLEMENTED PRIOR TO ANY LAND DISTURBING ACTIVITY ON THE CONSTRUCTION SITE. ANY MODIFICATION TO THE APPROVED EPSC PLAN MUST BE REVIEWED AND APPROVED BY MSD'S PRIVATE DEVELOPMENT REVIEW OFFICE. EPSC'S BMP'S SHALL BE INSTALLED PER THE PLAN AND MSD STANDARDS.
5. DETENTION BASINS, IF APPLICABLE, SHALL BE CONSTRUCTED FIRST AND SHALL PERFORM AS SEDIMENT BASINS DURING CONSTRUCTION UNTIL THE CONTRIBUTING DRAINAGE AREAS ARE SEEDED AND STABILIZED.
6. ACTIONS MUST BE TAKEN TO MINIMIZE THE TRACKING OF MUD AND SOIL FROM CONSTRUCTION AREAS ONTO PUBLIC ROADWAYS. SOIL TRACKED ONTO THE ROADWAY SHALL BE REMOVED DAILY.
7. SOIL STOCKPILES SHALL BE LOCATED AWAY FROM STREAMS, PONDS, SWALES, AND CATCH BASINS. STOCKPILES SHALL BE SEEDED, MULCHED, AND ADEQUATELY CONTAINED THROUGH THE USE OF SILT FENCE.
8. WHERE CONSTRUCTION OR LAND DISTURBANCE ACTIVITY WILL OR HAS TEMPORARILY CEASED ON ANY PORTION OF THE SITE, TEMPORARY SITE STABILIZATION MEASURES SHALL BE REQUIRED AS SOON AS PRACTICAL, BUT NOT LATER THAN 14 CALENDAR DAYS AFTER THE ACTIVITY HAS CEASED.

9. THERE SHALL BE NO INCREASE IN DRAINAGE RUN-OFF TO THE RIGHT OF WAY.
10. THERE SHALL BE NO COMMERCIAL SIGNS IN THE RIGHT-OF-WAY.
11. THERE SHOULD BE NO LANDSCAPING IN THE RIGHT-OF-WAY WITHOUT AN ENCROACHMENT PERMIT.
12. CONSTRUCTION PLANS, ENCROACHMENT PERMIT AND BOND WILL BE REQUIRED BY METRO PUBLIC WORKS FOR ALL WORK DONE WITHIN STREET RIGHT-OF-WAY.
13. NO INCREASE IN VELOCITY AT POINT OF DISCHARGE AT PROPERTY LINE.
14. VERGE AREAS WITHIN PUBLIC RIGHT-OF-WAY TO BE PROVIDED PER METRO PUBLIC WORKS.
15. COMPATIBLE UTILITY LINES (ELECTRIC, PHONE, CABLE) SHALL BE PLACED IN A COMMON TRENCH UNLESS OTHERWISE REQUIRED BY APPROPRIATE AGENCIES.
16. MITIGATION MEASURES FOR DUST CONTROL SHALL BE IN PLACE DURING DEMOLITION AND CONSTRUCTION ACTIVITIES TO PREVENT FUGITIVE PARTICULATE EMISSIONS FROM REACHING EXISTING ROADS AND NEIGHBORING PROPERTIES.
17. SHORT TERM BICYCLE PARKING DEVICE SHALL BE A DURABLE, SECURELY ANCHORED DEVICE THAT SUPPORTS THE FRAME OF THE BICYCLE, IS ABLE TO ACCOMMODATE A HIGH SECURITY LOCK AND IS 2'X8'X7" IN DIMENSION AS REQUIRED IN THE LDC.
18. ONSITE DETENTION WILL BE PROVIDED. POSTDEVELOPED PEAK FLOWS WILL BE LIMITED TO PREDEVELOPED PEAK FLOWS FOR THE 2, 10, 25, AND 100-YEAR STORMS OR TO THE CAPACITY OF THE DOWNSTREAM SYSTEM, WHICHEVER IS MORE RESTRICTIVE.
19. THE FINAL DESIGN OF THIS PROJECT MUST MEET ALL MS4 WATER QUALITY REGULATIONS ESTABLISHED BY MSD. SITE LAYOUT MAY CHANGE AT THE DESIGN PHASE DUE TO PROPER SIZING OF GREEN BEST MANAGEMENT PRACTICES.
20. KYTC AND COE APPROVAL REQUIRED PRIOR TO MSD CONSTRUCTION PLAN APPROVAL.
21. ALL RETAIL SHOPS MUST HAVE INDIVIDUAL CONNECTIONS PER MSD'S FATS, OIL, AND GREASE POLICY.
22. ACCESS EASEMENT MUST CONFORM TO ORDINANCE 187, SERIES 2003 AS AMENDED.

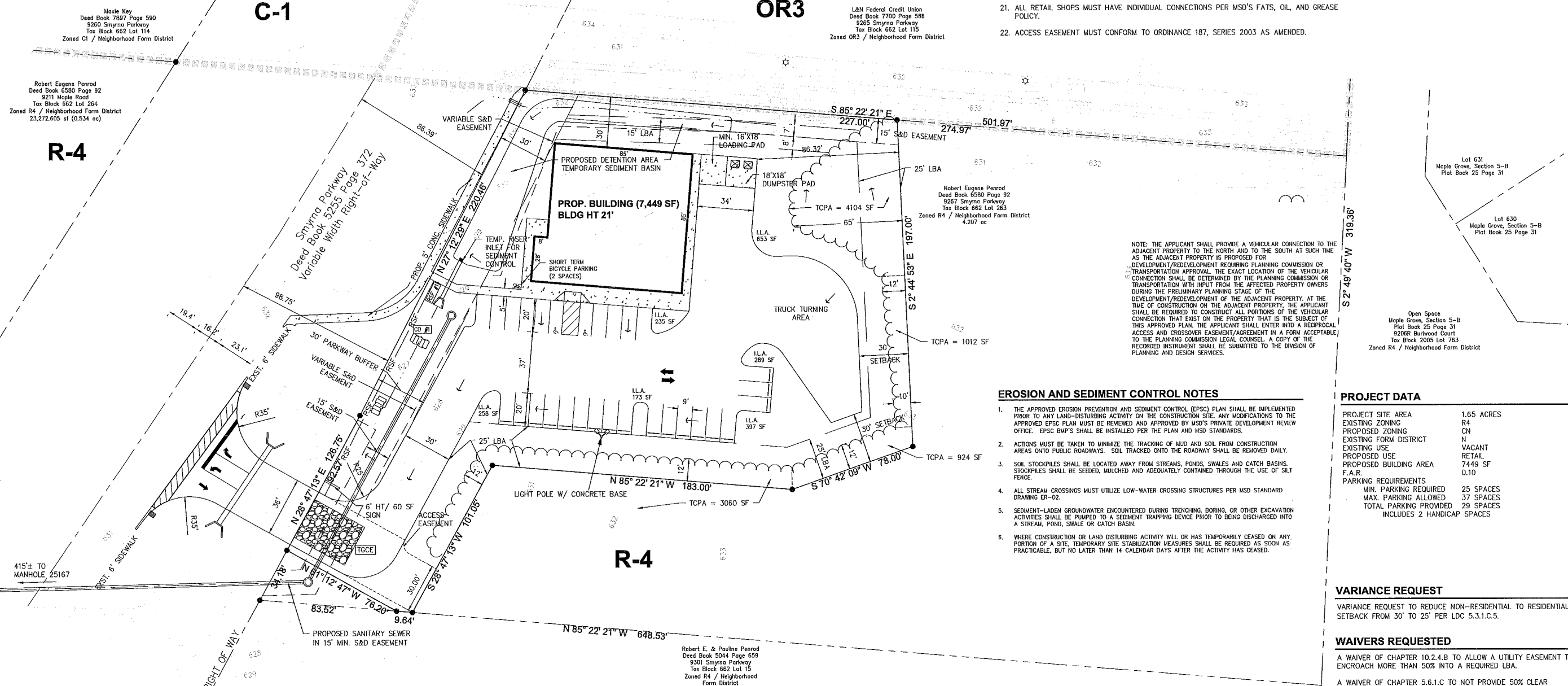
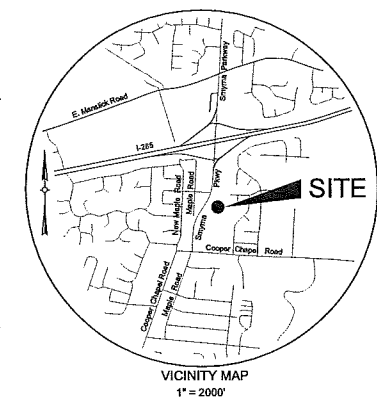

NOTE: THE APPLICANT SHALL PROVIDE A VEHICULAR CONNECTION TO THE ADJACENT PROPERTY TO THE NORTH AND TO THE SOUTH AT SUCH TIME AS THE ADJACENT PROPERTY IS PROPOSED FOR DEVELOPMENT/REDEVELOPMENT REQUIRING PLANNING COMMISSION OR TRANSPORTATION APPROVAL. THE EXACT LOCATION OF THE VEHICULAR CONNECTION SHALL BE DETERMINED BY THE PLANNING COMMISSION OR TRANSPORTATION WITH INPUT FROM THE AFFECTED PROPERTY OWNERS DURING THE PRELIMINARY PLANNING STAGE OF THE DEVELOPMENT/REDEVELOPMENT OF THE ADJACENT PROPERTY. AT THE TIME OF CONSTRUCTION ON THE ADJACENT PROPERTY, THE APPLICANT SHALL BE REQUIRED TO CONSTRUCT ALL PORTIONS OF THE VEHICULAR CONNECTION THAT EXIST ON THE PROPERTY THAT IS THE SUBJECT OF THIS APPROVED PLAN. THE APPLICANT SHALL ENTER INTO A REDUCED ACCESS AND CROSSOVER EASEMENT/AGREEMENT IN A FORM ACCEPTABLE TO THE PLANNING COMMISSION LEGAL COUNSEL. A COPY OF THE RECORDED INSTRUMENT SHALL BE SUBMITTED TO THE DIVISION OF PLANNING AND DESIGN SERVICES.

**EROSION AND SEDIMENT CONTROL NOTES**

1. THE APPROVED EROSION PREVENTION AND SEDIMENT CONTROL (EPSC) PLAN SHALL BE IMPLEMENTED PRIOR TO ANY LAND-DISTURBING ACTIVITY ON THE CONSTRUCTION SITE. ANY MODIFICATIONS TO THE APPROVED EPSC PLAN MUST BE REVIEWED AND APPROVED BY MSD'S PRIVATE DEVELOPMENT REVIEW OFFICE. EPSC BMP'S SHALL BE INSTALLED PER THE PLAN AND MSD STANDARDS.
2. ACTIONS MUST BE TAKEN TO MINIMIZE THE TRACKING OF MUD AND SOIL FROM CONSTRUCTION AREAS ONTO PUBLIC ROADWAYS. SOIL TRACKED ONTO THE ROADWAY SHALL BE REMOVED DAILY.
3. SOIL STOCKPILES SHALL BE LOCATED AWAY FROM STREAMS, PONDS, SWALES AND CATCH BASINS. STOCKPILES SHALL BE SEEDED, MULCHED AND ADEQUATELY CONTAINED THROUGH THE USE OF SILT FENCE.
4. ALL STREAM CROSSINGS MUST UTILIZE LOW-WATER CROSSING STRUCTURES PER MSD STANDARD DRAWING ER-02.
5. SEDIMENT-LADEN GROUNDWATER ENCOUNTERED DURING TRENCHING, BORING, OR OTHER EXCAVATION ACTIVITIES SHALL BE PUMPED TO A SEDIMENT TRAPPING DEVICE PRIOR TO BEING DISCHARGED INTO A STREAM, POND, SWALE OR CATCH BASIN.
6. WHERE CONSTRUCTION OR LAND DISTURBING ACTIVITY WILL OR HAS TEMPORARILY CEASED ON ANY PORTION OF A SITE, TEMPORARY SITE STABILIZATION MEASURES SHALL BE REQUIRED AS SOON AS PRACTICAL, BUT NOT LATER THAN 14 CALENDAR DAYS AFTER THE ACTIVITY HAS CEASED.

**PROJECT DATA**

PROJECT SITE AREA	1.65 ACRES
EXISTING ZONING	R4
PROPOSED ZONING	CN
EXISTING FORM DISTRICT	N
EXISTING USE	VACANT
PROPOSED USE	RETAIL
PROPOSED BUILDING AREA	7449 SF
F.A.R.	0.10
PARKING REQUIREMENTS	
MIN. PARKING REQUIRED	25 SPACES
MAX. PARKING ALLOWED	37 SPACES
TOTAL PARKING PROVIDED	29 SPACES
	INCLUDES 2 HANDICAP SPACES

**VARIANCE REQUEST**

VARIANCE REQUEST TO REDUCE NON-RESIDENTIAL TO RESIDENTIAL SETBACK FROM 30' TO 25' PER LDC 5.3.1.C.5.

**WAIVERS REQUESTED**

A WAIVER OF CHAPTER 10.2.4.B TO ALLOW A UTILITY EASEMENT TO ENCROACH MORE THAN 50% INTO A REQUIRED LBA.  
A WAIVER OF CHAPTER 5.6.1.C TO NOT PROVIDE 50% CLEAR GLAZING ON SMYRNA PARKWAY FACADE.

**GEOLOGIST'S CERTIFICATE**

Per the Kentucky Geologic Survey's online map, Karst Potential on and in the general proximity of the subject property is graphically shown as Low, and there are no mapped sinkholes shown in the immediate area. As shown on the Geologic Map of the Brocks Quadrangle, Bullitt and Jefferson County, Kentucky (Kefele, 1972), the subject property is underlain by the lower portions of the Louisville Limestone. Information included on that geologic map indicates that springs issue from the base of this formation directly above the Osgood Formation and Waldron Shale. An on-site field inspection of the subject property was conducted on April 27, 2016. At this time, much of the subject property was obscured by tree canopy with heavy undergrowth; however, no sinkholes or active springs were observed.



**TREE CANOPY REQUIREMENTS**

TREE CANOPY CATEGORY CLASS C	
TOTAL TREE CANOPY AREA	65,175 SF (76-100%)
TOTAL TREE AREA TO BE PRESERVED	9,100 SF (12.8%)
TOTAL SITE AREA	71,003 SF
EX. TREE CANOPY TO BE PRESERVED	9,100 SF (12.8%)
TREE CANOPY REQUIRED	12,781 SF (18%)
ADDITIONAL TREE CANOPY REQUIRED	4,260 SF (6%)
ADDITIONAL TREE CANOPY PROVIDED	4,320 SF (6.1%)
6 - 2" CAL. TYPE A TREES AT 720 SF EACH	
TOTAL TREE CANOPY PROVIDED	13,420 SF (18.9%)

**LANDSCAPE REQUIREMENTS**

PROPOSED V.U.A.	25,494 SF
7.5% I.L.A. REQUIREMENT	1951 SF
I.L.A. PROVIDED	2005 SF

**BICYCLE PARKING REQUIREMENTS**

LONG TERM: 2 SPACES REQUIRED (PROVIDED INSIDE BUILDING)  
SHORT TERM: 2 SPACES REQUIRED

**SITE DEVELOPMENT PLAN**

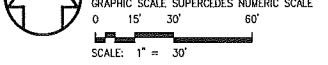

NO.	BY	REVISION	DESCRIPTION	DATE	CHK

**BTM Engineering, Inc.**  
 Consulting Engineers, Landscape Architects, Planners & Surveyors  
 "Serving the Bluegrass and Beyond"  
 3001 Bayl Springs Drive Louisville, Kentucky 40220  
 (502) 459-8402  
 www.btmeng.com

DATE	
SIGNATURE	
DATE	
SIGNATURE	

**DETAILED DISTRICT DEVELOPMENT PLAN**  
**9267 SMYRNA PARKWAY**  
**LOUISVILLE, KENTUCKY 40299**

ENR PROJECT NO. 150324  
 SITE INFORMATION: 9267 SMYRNA PARKWAY, LOT 263  
 4149 Stryker Road, Louisville, KY 40299  
 OWNER: ROBERT EUGENE PENROD  
 141 LAKEWOOD DRIVE  
 SCOTTSDALE, KY 41107

DEVELOPER: BTM ENGINEERING, INC.  
 1480 DETROIT AVENUE SUITE 1500  
 LANEWOOD, OH 44107

DRAWN BY: PMB  
 CHECKED BY: JMA  
 DATE: 2-1-16  
 DRAWING: 150324-DDP  
 SCALE: 1" = 30'

16 ZONE 1005  
MSD WM #11349

P1.00

George Brian Wyatt, PG 820

Date



**VARIANCE JUSTIFICATION**  
**Zaremba Group, LLC, Applicant**  
**9267 Smyrna Parkway**

**THIS IS A VARIANCE FROM THE 30-FOOT SETBACK/BUILD-TO LINE (LDC §5.3.1.C.5 (Table 5.3.2)) TO 25-FEET FOR THIS PROPOSED RETAIL DEVELOPMENT ALONG SMYRNA PARKWAY.**

- 1. Explain how the variance will not adversely affect the public health, safety or welfare.**

The variance will enable the appropriate positioning of the access drive, the parking area and truck turning area on the site to allow for safe vehicular and pedestrian movement. It is anticipated that the development plan will be approved by the Louisville Department of Public Works, which approval will indicate, among other things, that the plan provides for safe and efficient movement of vehicles and pedestrians. Thus, the variance will not have an adverse effect on the public health, safety or welfare.

- 2. Explain how the variance will not alter the essential character of the general vicinity.**

The variance would not alter the essential character of the general vicinity because the existing use of the adjoining properties to the north and the south along Smyrna Parkway is for commercial purposes. Moreover, the Highview Neighborhood Plan recommends that commercial uses are appropriate for the area which includes this site.

- 3. Explain how the variance will not cause a hazard or a nuisance to the public.**

The variance will not cause a hazard or nuisance to the public because the Louisville Department of Public Works is anticipated to approve the development plan. This approval will indicate, among other things, that the layout of the site is safe for motor vehicles and pedestrians on site, that there are adequate parking facilities on-site and that access points to and from the site are safe. Therefore, the variance will not cause a hazard or nuisance to the public.

**4. Explain how the variance will not allow an unreasonable circumvention of the requirements of the zoning regulations.**

The variance will not allow an unreasonable circumvention of the requirements of the zoning regulations because the variance will allow for more compact development on-site (i.e., consistent with the Comprehensive Plan) and is consistent with the recommendations of the Highview Neighborhood Plan.

***Additional considerations.***

**1. Explain how the variance arises from special circumstances, which do not generally apply to land in the general vicinity (please specify/identify).**

The site is bound by an existing residential subdivision on the east, by the company headquarters for L&N Bank to the north, by Smyrna Parkway to the west and by undeveloped land currently zoned as R-4 to the south. The proposed configuration with its 5-foot reduction in setbacks requires the location of the building, the access drive, the parking areas and the truck turning area at specific locations to allow motor vehicles, including delivery trucks, to enter and exit safely, as well as allowing customers to enter and exit the store in a safe manner. Moreover, the Highview Neighborhood Plan recommends that the immediate vicinity is appropriate for higher intensity uses (including commercial uses). This configuration does not generally apply to land not located in "Neighborhood Activity Centers/Nodes" as provided for in the Highview Neighborhood Plan.

**2. Explain how the strict application of the provisions of the regulation would deprive the applicant of the reasonable use of the land or would create unnecessary hardship.**

Given the applicable 30-foot side yard and rear yard setbacks along the north, east and south boundary lines of the site and the parkway setbacks along the west boundary line, if the variance were not granted, the strict application of the regulation would require the reduction in the number of parking spaces, the access drive and/or the truck turning area available for the development so as to potentially place the site out of compliance with requirements of the Land Development Code. Such an alternate site configuration would negatively impact the circulation of the development in a manner that could result in potentially unsafe vehicular and pedestrian movement and/or unsafe interaction with delivery trucks visiting the development and as a result would create an unnecessary hardship.

**3. Are the circumstances the result of actions of the applicant taken subsequent to the adoption of the regulation from which relief is sought?**

No. The circumstances are the result of the configuration of the site and the fact that required side yard, rear yard and parkway setbacks limit development options for this site.

0132493.0631821 4831-2085-6880v3



## LAND DEVELOPMENT CODE WAIVER

Zaremba Group, LLC, Applicant  
9267 Smyrna Parkway

### LAND DEVELOPMENT CODE §10.2.4.B

#### **A REQUEST FOR A WAIVER OF LAND DEVELOPMENT CODE (“LDC”) § 10.2.4.B TO ALLOW SEWER AND DRAINAGE EASEMENTS TO ENCROACH INTO THE LANDSCAPE BUFFER AREAS (“LBA”) BY MORE THAN 50% OF THE LBA.**

**Reason.** All landscaping materials required by the LDC will be planted and maintained by the applicant. No reduction in the amount of landscaping will occur by virtue of the sewer and drainage easement overlap.

**A. The waiver will not adversely affect adjacent property owners.**

The waiver will not adversely affect adjacent property owners because the waiver only affects the location of internal sewer and drainage easements on the subject property and does not impact the landscaping to be planted and maintained in the affected areas.

**B. The waiver will not violate the Comprehensive Plan.**

The requested waiver conforms to the Comprehensive Plan because all design criteria meet Compatibility Guideline 3 and Policies 4, 21 and 22, Flooding and Stormwater Guideline 10 and Policy 11, and Landscape Character Guideline 13 and Policies 4 and 7.

Compatibility Guideline 3. The waiver conforms to Compatibility Guideline 3 and all applicable Policies adopted thereunder, including Policies 4, 21 and 22 because plant materials otherwise required to provide on-site vegetative buffers will be implemented which, together with the preservation of existing tree canopy, will create an appropriate transition between the subject property and the adjacent residential uses.

Landscape Character Guideline 10. The waiver conforms to Landscape Character Guideline 10 and all applicable Policies adopted thereunder, including Policy 11, because the waiver will not inhibit or prevent the development of the subject property to allow for on-site mitigation of stormwater runoff in a manner acceptable to the Metropolitan Sewer District. Peak stormwater runoff rates post-development will not exceed pre-development rates.

Landscape Character Guideline 13. The waiver conforms to Landscape Character Guideline 13 and all applicable Policies adopted thereunder, including Policies 4 and 6 because the plant materials will be provided pursuant to the LDC and will be maintained by the applicant, regardless of the grant of the waiver.

**C. The waiver conforms to the intent of the Land Development Code.**

The waiver conforms to the intent of the Land Development Code to provide for adequate landscaping and tree canopy to reduce any potential for visual nuisance. Because all landscape materials required by the LDC will be implemented, the waiver conforms to the intent of the Land Development Code.

**D. The extent of the waiver of the regulation is the minimum necessary to afford relief to the applicant.**

The waiver is the minimum necessary to afford relief to the applicant because the grant of the waiver will enable sewer and drainage easements to substantially co-exist within the landscape buffer areas; however, the landscape materials provided will not be reduced. Thus, the extent of the waiver of the regulation is the minimum necessary to afford relief to the applicant.

**E. The strict application of the regulation would deprive the applicant of the reasonable use of the land or would create an unnecessary hardship on the applicant.**

The strict application of the regulation would deprive the applicant of the reasonable use of the land and would create an unnecessary hardship on the applicant because of the configuration of this development as shown on the detailed development plan is the only feasible configuration given the size of the subject property and the applicable 30-foot side yard and rear yard setbacks along the north, east and south boundary lines of the subject property and the parkway setbacks along the west boundary line. If the waiver were not granted, the strict application of the regulation would require a reconfiguration of the development resulting in a reduction in the number of parking spaces, the access drive and/or the truck turning area available for the development so as to potentially place the site out of compliance with requirements of the Land Development Code. Such an alternate site configuration would negatively impact the circulation of the development in a manner that could result in potentially unsafe vehicular and pedestrian movement and/or unsafe interaction with delivery trucks visiting the development and as a result would create an unnecessary hardship.



**SUPPLEMENTAL INFORMATION SHEET ADDENDUM  
LAND DEVELOPMENT CODE WAIVER SUBMITTAL REQUIREMENTS**

**Request for Waiver of Land Development Code (“LDC”) §5.6.1.C.1  
Zaremba Group, LLC, Applicant**

**9267 Smyrna Parkway**

**Request:** A waiver is requested from LDC §5.6.1.C.1 to allow less than 50% clear glazing.

**A. The requested waiver conforms to the Comprehensive Plan and the intent of the Land Development Code.**

**1. The requested waiver conforms to the Comprehensive Plan.**

The requested waiver conforms to the Comprehensive Plan because it conforms to Compatibility Guideline 3 and Policy 3.4 and 3.9.

**Compatibility Guideline 3.** The proposal conforms to Compatibility Guideline 3 and all applicable Policies adopted thereunder, including Policy 3.4 and 3.9 because interior stock space is needed to provide for consumer goods including grocery and sundry items. If this interior space cannot be provided within this grocery and sundries store, then it will be unable to provide those goods in a manner similar to all other Dollar General stores. In addition, due to the distance of the building from the sidewalk and right-of-way line, the waiver has minimal impact on the intent of the requirement.

The requested waiver conforms to all other applicable Goals, Objectives, Guidelines and Policies of the Comprehensive Plan.

**2. The requested waiver conforms to the intent of the Land Development Code.**

The requested waiver conforms to the intent of the Land Development Code. The intent of the Code is to enliven the building façade; however, for this type of land use it is necessary to provide adequate interior wall space to locate consumer goods. Due to the distance of the building from the street edge and the sidewalk, the waiver is a minimal request.

**B. Compliance with the regulation is not appropriate; the granting of the waiver will result in a development more in keeping with the Comprehensive Plan and the overall intent of the Land Development Code.**

Compliance with the regulation would substantially impact the desired site pattern of the development because the grocery store would be unable to stock the consumer goods which Dollar General customers expect when coming to this or any other Dollar General location. Thus, compliance with the regulation is not appropriate and the granting of the

waiver would result in a development more in keeping with the Comprehensive Plan and the overall intent of the Land Development Code.

**C. The requested waiver will have no adverse impacts on adjacent property owners.**

The requested waiver will have no adverse impacts on adjacent property owners because it only affects the amount of glazing on this building with no effect on adjacent property owners.

**D. The strict application of the regulation would deprive the applicant of the reasonable use of the land or would create an unnecessary hardship on the applicant.**

The strict application of the regulation would deprive the applicant of the reasonable use of the land and would create an unnecessary hardship on the applicant because the application of the regulation to this site would cause Dollar General not to be able to provide the consumer goods provided at all other Dollar General stores



## DEMONSTRATION OF APPROPRIATENESS

Zaremba Group, LLC  
9267 Smyrna Parkway  
Request for Change in Zone from R-4 to C-N  
Case No. 16-ZONE-1005

### I. The proposal conforms to the Comprehensive Plan for Louisville and Jefferson County, Kentucky.

The proposed zone change from R-4 Residential Single Family District to C-N Neighborhood Commercial District (the "proposal") conforms to KRS 100.213 because it is in agreement with the adopted Comprehensive Plan for Louisville and Jefferson County, Kentucky, within which this property lies.

The proposal also conforms to the Highview Neighborhood Plan. Under Form District Policy A.2.(e) of the Plan Elements of the Cornerstone 2020 Comprehensive Plan (the "Comprehensive Plan"), plans, studies and strategies legislatively developed subsequent to the adoption of the Comprehensive Plan, such as the Highview Neighborhood Plan adopted in June 2015, are intended to take precedence over the more general guidelines of Cornerstone 2020. The Highview Neighborhood Plan makes land use recommendations that encourage commercial development to occur in dedicated neighborhood activity centers. Land Use Recommendation #2 of the Highview Neighborhood Plan indicates that neighborhood activity centers/nodes shown in Figure 2.4 are the preferred location for future medium to high density development, and provides that such centers/nodes should be centered around a defined intersection and be walkable in size, defined as being no more than ¼ mile from edge to edge. In addition, Land Use Recommendation #6 of the Highview Neighborhood Plan recommends that commercial development should be limited within neighborhood activity centers shown in Figure 3.7. The Proposal complies with the Highview Neighborhood Plan as the Subject Property is within the neighborhood activity center located in and around the intersection of Smyrna Parkway and Cooper Chapel Road as shown in Figure 2.4 and Figure 3.7 of the Highview Neighborhood Plan and such center is walkable in size in that the distance between the Smyrna/Cooper Chapel intersection and the northern entrance of L&N Credit Union development is less than ¼ mile from edge to edge.

Specific applicable Goals, Objectives, Guidelines and Policies are presented in this Justification Statement.

**Community Form Guideline 1.** The Proposal conforms to Community Form Guideline 1 and all applicable Policies adopted thereunder, including Policy 1.B.3. The site is located within the Neighborhood Form District, and is consistent with the Neighborhood Form District because the grocery and sundries store will

provide a necessary service near existing residential areas in the Smyrna Parkway-Cooper Chapel Road area. The size and scale of the proposal is also consistent with this Form District, which is located at the intersection of a primary collector (Smyrna Parkway) and an Expressway (Gene Snyder Freeway) and is consistent with the Highview Neighborhood Plan given that the Subject Property is within the neighborhood activity center which is located at the intersection Smyrna Parkway and Cooper Chapel Road.

**Compatibility Guideline 3.** The Proposal conforms to Compatibility Guideline 3 and all applicable Policies adopted thereunder, including Policies 3.1, 3.2, 3.4, 3.6, 3.7, 3.8, 3.9, 3.11, 3.12, 3.21, 3.22, 3.23, 3.24 and 3.28. The site and structures will be accessible to persons with disabilities, and will be in accordance with all local, state and federal laws protecting persons with disabilities. Building materials will be compatible with the nearby commercial uses and residential areas, and will be Nichiha brick veneer panels on the three façades facing Smyrna Parkway and the adjacent properties to the north and south, glass and the use of corrugated steel for the rear façade facing the heavily treed portion of the Parent Tract to the east of the Subject Property. The building and related parking are situated toward the center of the property, which will reduce visibility of parking areas from adjacent streets, the adjacent properties to the north and south and the adjacent residential subdivision to the east. Lighting will conform to the Land Development Code. It is anticipated that the Proposal will receive the approval of Louisville Metro Department of Public Works (“DPW”). It is anticipated that the Proposal will receive the approval of Louisville Air Pollution Control District (“APCD”). It is anticipated that the Proposal will receive the approval of the Metropolitan Sewer Department (“MSD”). All setback requirements have been met, [except where one maximum setback is exceeded and a variance has been requested]. Appropriate landscape buffer requirements have been met. The proposal will conform with all signage requirements of the Land Development Code. Appropriate transition between the adjacent commercial uses, residential areas and the proposed development will be ensured by substantial perimeter landscape and buffer areas around the Subject Property.

**Natural Areas and Scenic and Historic Resources Guideline 5.** The Proposal conforms to Natural Areas and Scenic and Historic Resources Guideline 5 and all applicable Policies adopted thereunder, including Policies 5.1, 5.2, 5.3, 5.4 and 5.6 because the Subject Property does not appear to affect any historic resources and the proposed location of the developed portions of the Subject Property respect the heavily treed portions of the Parent Tract, and other areas with steep slopes and unstable soils.

**Circulation Guideline 7.** The Proposal conforms to Circulation Guideline 7 and all applicable Policies adopted thereunder, including Policies 7.1, 7.2, 7.3, 7.9, 7.10, 7.15 and 7.16. Pedestrian connectivity is provided throughout and sidewalks will be constructed internally along all dedicated roadways. Access is provided to and from Smyrna Parkway. The site will be served by the transit services of the

Transit Authority of River City ("TARC"). TARC Route #45 Okolona Express provides service for the site because Smyrna Parkway is part of the route. It is anticipated that no dedication of right-of-way will be required by the Department of Public Works. The development exceeds the minimum parking requirement of the Land Development Code. Entry design serving the Subject Property and the future development areas of the Parent Tract is unified.

**Bicycle, Pedestrian and Transit Guideline 9.** The Proposal conforms to Bicycle, Pedestrian and Transit Guideline 9 and all applicable Policies adopted thereunder, including Policies 9.1, 9.2, 9.3 and 9.4. Sidewalks will be constructed internally along all dedicated roadways providing easy pedestrian access to and through the Subject Property. Transit service is provided along this segment of Smyrna Parkway via TARC Route 45.

**Flooding and Stormwater Guideline 10.** The Proposal conforms to Flooding and Stormwater Guideline 10 and all applicable Policies adopted thereunder, including Policies 10.1, 10.2, 10.3, 10.4, 10.7, 10.10 and 10.11. The development of the site will minimize the potential for the impacts of flooding and effectively manages stormwater runoff. The proposal will not have an adverse effect on the watershed based on full development of the watershed. On-site detention facilities will provide for adequate compensatory stormwater storage. There is no impact to the regulatory floodplain because all structures will be located above the floodplain. No buildings are proposed to be located within the 100-year FEMA regulatory floodplain. It is anticipated that the Proposal will receive the approval of the Metropolitan Sewer District ("MSD"). Moreover, the on-site drainage system will accommodate the "through" drainage system of water flows on-site and off-site. Peak stormwater runoff rates post-development will not exceed pre-development rates.

**Air Quality Guideline 12.** The proposal conforms to Air Quality Guideline 12 and all applicable Policies adopted thereunder, including Policies 12.1, 12.3 and 12.8. It is anticipated that the development will not generate significant volumes of traffic to cause a degradation of ambient air quality standards. The proposal is situated at a location where it can take advantage of TARC Route #45. Sidewalks are proposed for the frontage of the Subject Property along Smyrna Parkway. It is anticipated that the Louisville Air Pollution Control District will approve the Proposal. If approved, the APCD approval will indicate, among other things, that the proposal conforms to Air Quality Guideline 12 and related all Policies because no adverse air quality impacts will be generated by the proposal.

**Landscape Character Guideline 13.** The proposal conforms to Landscape Character Guideline 13 and all applicable Policies adopted thereunder, including Policies 1, 2, 4, 5 and 6. A Tree Preservation Plan will be submitted to the Planning Commission staff for review and approval prior to the beginning of construction. The heavily treed portion of the Parent Tract to the east of the Subject Property will be preserved so as to provide a natural buffer between the Subject Property

and the adjacent residential subdivision. Landscaping – native plant species -- will be provided in accordance with Chapter 10 of the Land Development Code wherever possible. Additional Landscape Buffer Areas around the perimeter of the site and roadways, wherever required, will be implemented in accordance with the Land Development Code specifications.

**Infrastructure Guideline 14.** The proposal conforms to Infrastructure Guideline 14 and all applicable Policies adopted thereunder, including Policies 14.2, 14.3, 14.4, 14.6 and 14.7. The proposal has adequate service for all necessary utilities. An adequate water supply for domestic and fire-fighting purposes serves the site. New utilities will be located underground wherever possible and will be situated where recommended by each utility for appropriate maintenance and repair access.

**Community Facilities Guideline 15.** The proposal conforms to Community Facilities Guideline 15 and all applicable Policies adopted thereunder, including Policy 15.9. Adequate firefighting services will be provided by the Highview Fire Protection District.

The proposal conforms to all other applicable Goals, Objectives, Guidelines and Policies of the Comprehensive Plan.

- II. **All necessary utilities, including gas, electric, water, telephone, cable and telecommunications, either presently exist on-site or will be constructed. Essential public services, including sidewalks, will be constructed to serve the site as described above.**
- III. **Implementation of proposed uses is anticipated to begin within twelve (12) months of final approval.**





## PROPOSED FINDINGS OF FACT

**Submitted by:  
Zaremba Group, LLC  
9267 Smyrna Parkway  
Request for Change in Zone from R-4 to C-N**

**WHEREAS**, The Planning Commission Finds That the proposal conforms to KRS 100.213 because it is in agreement with Comprehensive Plan for Louisville and Jefferson County, Kentucky as detailed in these Findings of Fact; and

**WHEREAS**, The Planning Commission Further Finds That the proposal conforms to the Highview Neighborhood Plan and the applicable recommendations set forth therein, including Land Use Recommendation #2 and Land Use Recommendation #6 because the 1.65 acre site is situated within the dedicated neighborhood activity center/node which is centered in and around the intersection of Smyrna Parkway and Cooper Chapel Road, which the Highview Neighborhood identifies as a preferred location for medium to high density development within the Highview Neighborhood and because such center/node is walkable in size; and

**WHEREAS**, The Planning Commission Further Finds That the proposal conforms to Community Form Guideline 1 and all applicable Policies adopted thereunder, including Policy 1.B.3 because the 1.65 acre site lies within the Neighborhood Form District and is compliant therewith; because the development will be easily accessible by pedestrians on foot due to the sidewalks that will be constructed internally along Smyrna Parkway (along the western boundary line of the site as shown on the development plan); and because the proposed development is located within the Smyrna Parkway/Cooper Chapel Road neighborhood activity center which is the preferred location for medium to high density development under the Highview Neighborhood Plan; and

**WHEREAS**, The Planning Commission Further Finds That the proposal conforms to Compatibility Guideline 3 and all applicable Policies adopted thereunder, including Policies 3.1, 3.2, 3.4, 3.6, 3.7, 3.8, 3.9, 3.11, 3.12, 3.21, 3.22, 3.23, 3.24 and 3.28 because the site and structures will be accessible to persons with disabilities, and will be in accordance with all local, state and federal laws protecting persons with disabilities; because the proposed building materials will be compatible with the nearby commercial and residential areas; because the building and related parking will be situated toward the center of the property, which will reduce visibility of parking areas from adjacent streets, the adjacent properties to the north and south and the adjacent residential subdivision to the east; because the lighting will conform to the Land Development Code; because the proposed development plan has received the approval of Louisville Metro Department of Public Works ("DPW"), the Louisville Air Pollution Control District ("APCD") and the Metropolitan Sewer Department ("MSD"); because all setback requirements have been met, except where one maximum setback is exceeded and a variance has been granted; because appropriate landscape buffer requirements will be met; because the

proposed development will conform with all signage requirements of the Land Development Code; and because an appropriate transition between the adjacent commercial uses, residential areas and the proposed development will be ensured by substantial perimeter landscape and buffer areas around the site; and

**WHEREAS**, The Planning Commission Further Finds That the proposal conforms to Natural Areas and Scenic and Historic Resources Guideline 5 and all applicable Policies adopted thereunder, including Policies 5.1, 5.2, 5.3, 5.4 and 5.6 because the site does not appear to affect any historic resources and the proposed location of the developed portions of the site respect the heavily treed portions of the adjacent Parent Tract, and other areas with steep slopes and unstable soils; and

**WHEREAS**, The Planning Commission Further Finds That the proposal conforms Circulation Guideline 7 and all applicable Policies adopted thereunder, including Policies 7.1, 7.2, 7.3, 7.9, 7.10, 7.15 and 7.16 because pedestrian connectivity will be provided throughout and sidewalks will be constructed internally along all dedicated roadways; because access is provided to and from Smyrna Parkway; because the site is served by the transit services of the Transit Authority of River City ("TARC") via TARC Route #45 Okolona Express which provides service for the site because Smyrna Parkway is part of this route; because it is anticipated that no dedication of right-of-way will be required by the Louisville Department of Public Works ("DPW"); because the proposed development exceeds the minimum parking requirements of the Land Development Code; and because the entry design serving the site and the future development areas of the adjacent Parent Tract is unified; and

**WHEREAS**, The Planning Commission Further Finds That the proposal conforms to Bicycle, Pedestrian and Transit Guideline 9 and all applicable Policies adopted thereunder, including Policies 9.1, 9.2, 9.3 and 9.4 because sidewalks will be constructed internally along all dedicated roadways providing easy pedestrian access to and through the site and because transit service is provided along this segment of Smyrna Parkway via TARC Route 45; and

**WHEREAS**, The Planning Commission Further Finds That the proposal conforms to Flooding and Stormwater Guideline 10 and all applicable Policies adopted thereunder, including Policies 10.1, 10.2, 10.3, 10.4, 10.7, 10.10 and 10.11 because the development of the site will minimize the potential for the impacts of flooding and effectively manages stormwater runoff; because the proposed development will not have an adverse effect on the watershed based on full development of the watershed; because on-site detention facilities will provide for adequate compensatory stormwater storage; because there is no impact to the regulatory floodplain because all structures will be located above the floodplain; because no buildings are proposed to be located within the 100-year FEMA regulatory floodplain; and because the proposal has received the approval of Louisville Metropolitan Sewer District ("MSD") which indicates, among other things, that the on-site drainage system will accommodate the "through" drainage system of water flows on-site and off-site and that peak stormwater runoff rates post-development will not exceed pre-development rates; and

**WHEREAS,** The Planning Commission Further Finds That the proposal conforms to Air Quality Guideline 12 and all applicable Policies adopted thereunder, including Policies 12.1, 12.3 and 12.8 because the development will not generate significant volumes of traffic to cause a degradation of ambient air quality standards; because the proposal is situated at a location where it can take advantage of TARC Route #45; because sidewalks are proposed for the frontage of the site along Smyrna Parkway; and because the Louisville Air Pollution Control District (the "APCD") has approved the proposal which indicates, among other things, that the proposal conforms to Air Quality Guideline 12 and related all Policies because no adverse air quality impacts will be generated by the proposal; and

**WHEREAS,** The Planning Commission Further Finds That the proposal conforms to Landscape Character Guideline 13 and all applicable Policies adopted thereunder, including Policies 1, 2, 4, 5 and 6 because a Tree Preservation Plan will be submitted to the Planning Commission staff for review and approval prior to the beginning of construction; because the heavily treed portion of the adjacent Parent Tract to the east of the site will be preserved so as to provide a natural buffer between the site and the adjacent residential subdivision; because native plant species will be provided in accordance with Chapter 10 of the Land Development Code wherever possible; and because additional Landscape Buffer Areas around the perimeter of the site and roadways, wherever required, will be implemented in accordance with the Land Development Code specifications; and

**WHEREAS,** The Planning Commission Further Finds That the proposal conforms to Infrastructure Guideline 14 and all applicable Policies adopted thereunder, including Policies 14.2, 14.3, 14.4, 14.6 and 14.7 because the proposal has adequate service for all necessary utilities; because an adequate water supply for domestic and fire-fighting purposes serves the site; and because new utilities will be located underground wherever possible and will be situated where recommended by each utility for appropriate maintenance and repair access; and

**WHEREAS,** The Planning Commission Further Finds That the proposal conforms to Community Facilities Guideline 15 and all applicable Policies adopted thereunder, including Policy 15.9 because adequate firefighting services will be provided by the Highview Fire Protection District.

**WHEREAS,** The Planning Commission Further Finds That the proposal conforms to all other applicable Goals, Objectives, Guidelines and Policies of the Comprehensive Plan; and

**WHEREAS,** The Planning Commission Further Finds That all necessary utilities, including gas, electric, water, telephone, cable and telecommunications, either presently exist on-site or will be constructed and all essential public services, including sidewalks, will be constructed to serve the site; and

**WHEREAS**, The Planning Commission Further Finds That Implementation of proposed uses is anticipated to begin within twelve (12) months of final approval.

**NOW, THEREFORE, BE IT RESOLVED THAT THE PLANNING COMMISSION DOES HEREBY RECOMMEND THAT THE PROPOSED CHANGE OF ZONE FROM R-4 TO C-N BE APPROVED.**

0132493.0631821 4829-9223-4034v1