

Docket No. 17ZONE1025

Proposed Conditional Use Permit (CUP) to allow a senior living facility at the rear of the site and a rezoning from R-4 to C-N for a bank out-lot fronting on Brownsboro Road on property located at 4922 Brownsboro Road



INDEX

1. LOJIC Zoning Map and boundaries of the City of Crossgate
2. Aerial photographs of the site and surrounding area
3. Ground level photographs of the site and surrounding area
4. Neighborhood Meeting notice list map, letter to neighbors inviting them to the meeting and summary of meeting
5. Previous Development Plans
6. Proposed Development Plan
7. Building elevations
8. Traffic Study
9. Lighting
10. Proposed findings of fact pertaining to compliance with the Comprehensive Plan

TAB 1

**LOJIC ZONING MAP AND BOUNDARIES OF
THE CITY OF CROSSGATE**

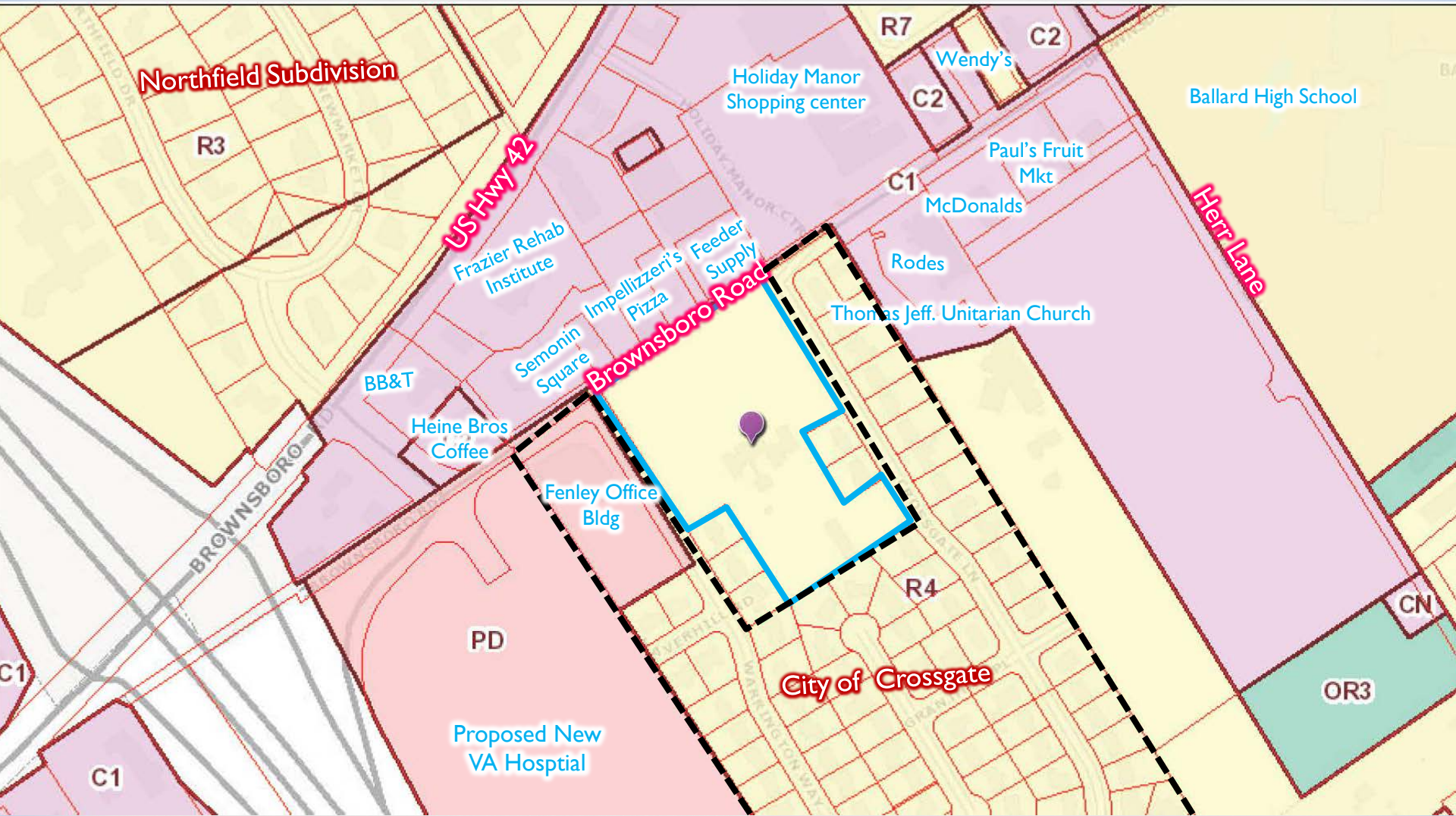

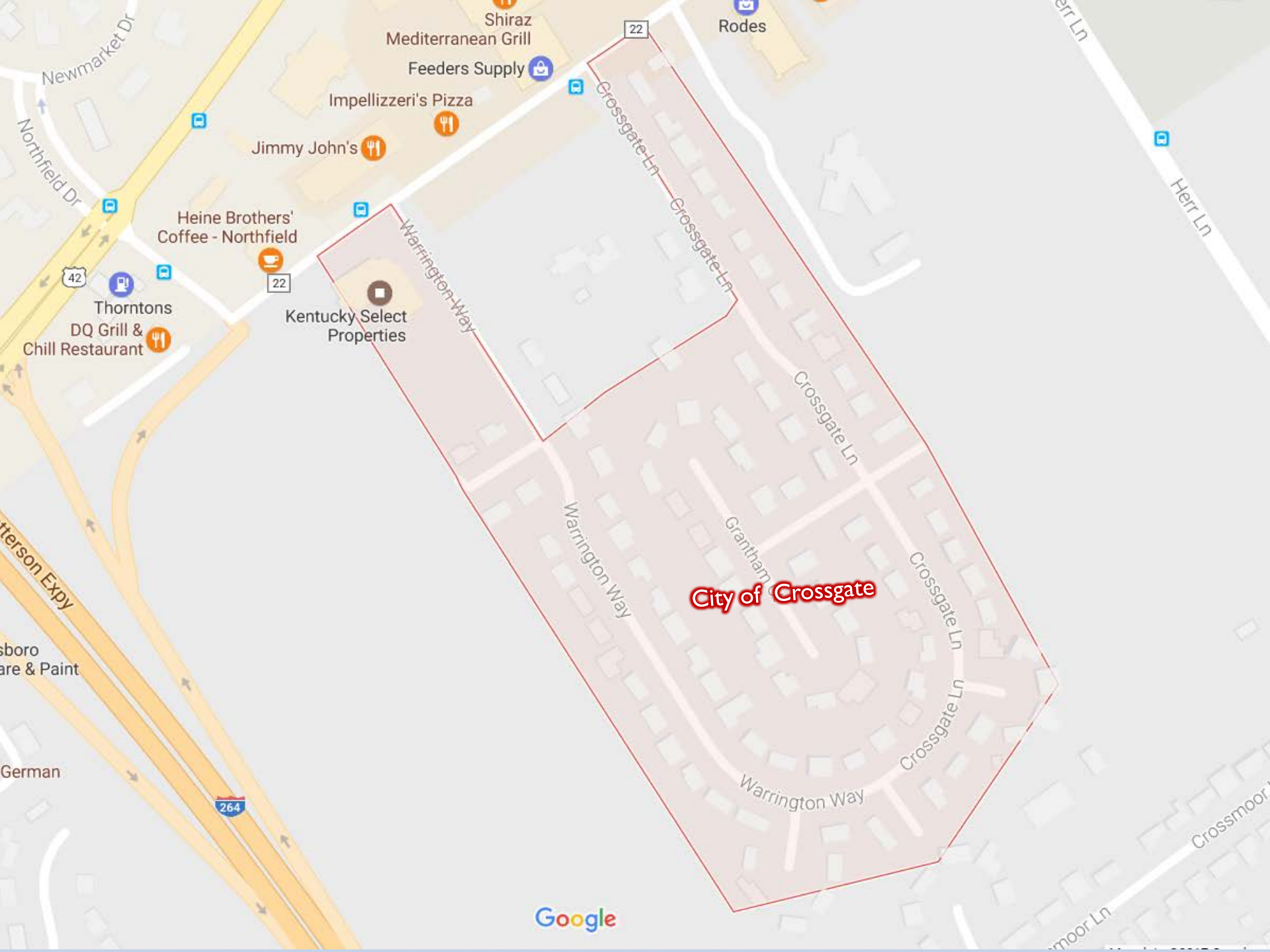

City of Crossgate

TAB 2

AERIAL PHOTOGRAPHS OF THE SITE AND SURROUNDING AREA





SITE

Northfield @ US 42

Warrington Way

Gross

© 2016 Google



TAB 3

GROUND LEVEL PHOTOGRAPHS OF THE SITE AND SURROUNDING AREA



Existing home on site.

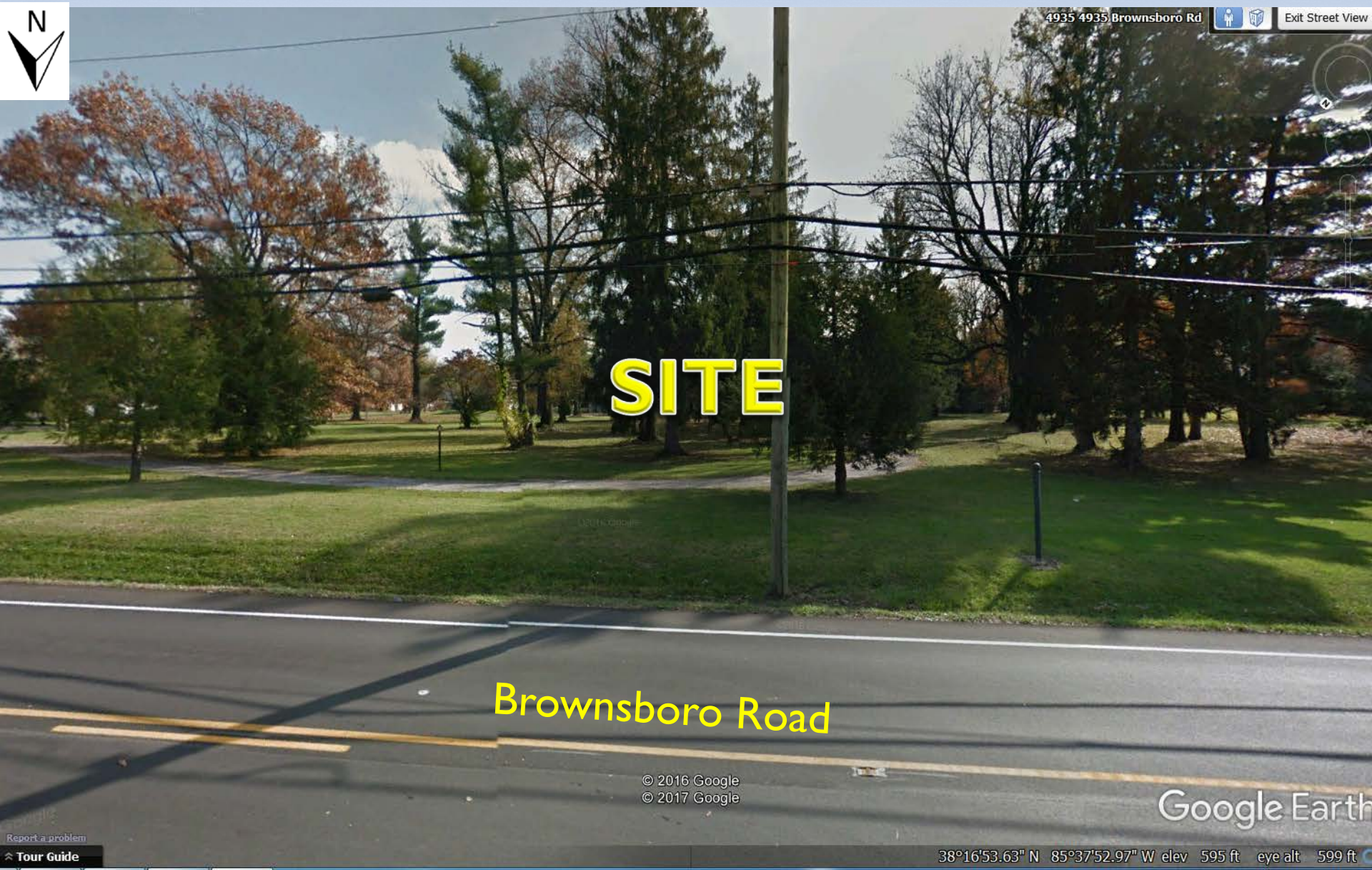

SITE

Brownsboro Road

© 2016 Google
© 2017 Google

Google Earth

38°16'53.63" N 85°37'52.97" W elev 595 ft eye alt 599 ft

View of site from Brownsboro Road.



SITE

Brownsboro Road

© 2016 Google
© 2017 Google

Google Earth

View of Brownsboro Road looking east. Site is to the right.



SITE

Brownsboro Road

© 2016 Google
© 2017 Google

Google Earth

View of site from Brownsboro Road looking southwest.

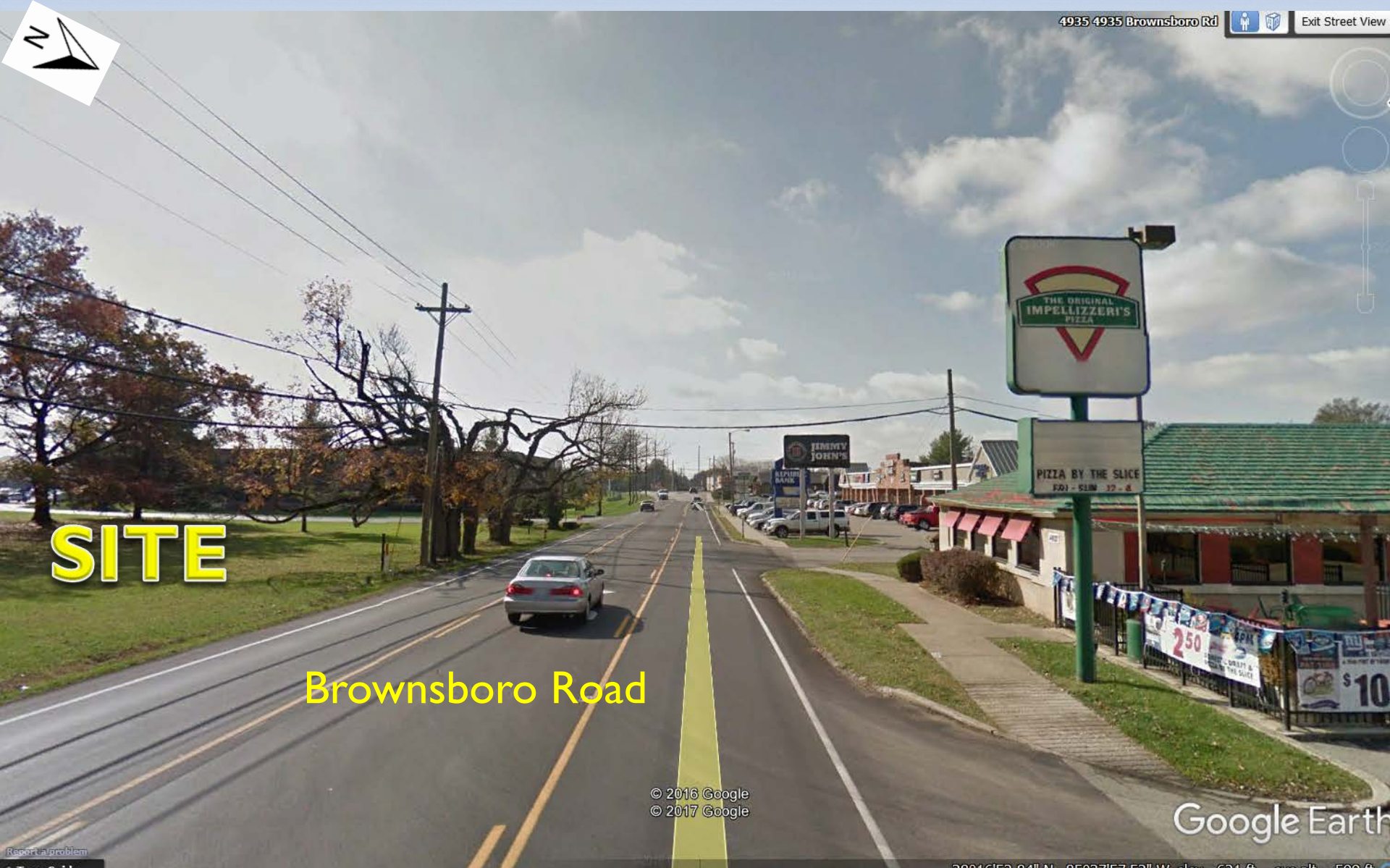

SITE

Brownsboro Road

© 2016 Google
© 2017 Google

Google Earth

38°16'52.94" N, 85°27'57.53" W, elev: 691 ft, eye alt: 500 ft

View of Brownsboro Road looking west towards I-264. Site is to the left.

TAB 4

NEIGHBORHOOD MEETING NOTICE LIST
MAP, LETTER TO NEIGHBORS INVITING
THEM TO THE MEETING AND SUMMARY
OF MEETING

ADJOINING PROPERTY OWNER NOTICE LIST MAP WHEREIN 79 NEIGHBORS WERE INVITED TO THE VARIOUS NEIGHBORHOOD MEETINGS AND THE SUBSEQUENT LD&T AND PLANNING COMMISSION PUBLIC HEARING.

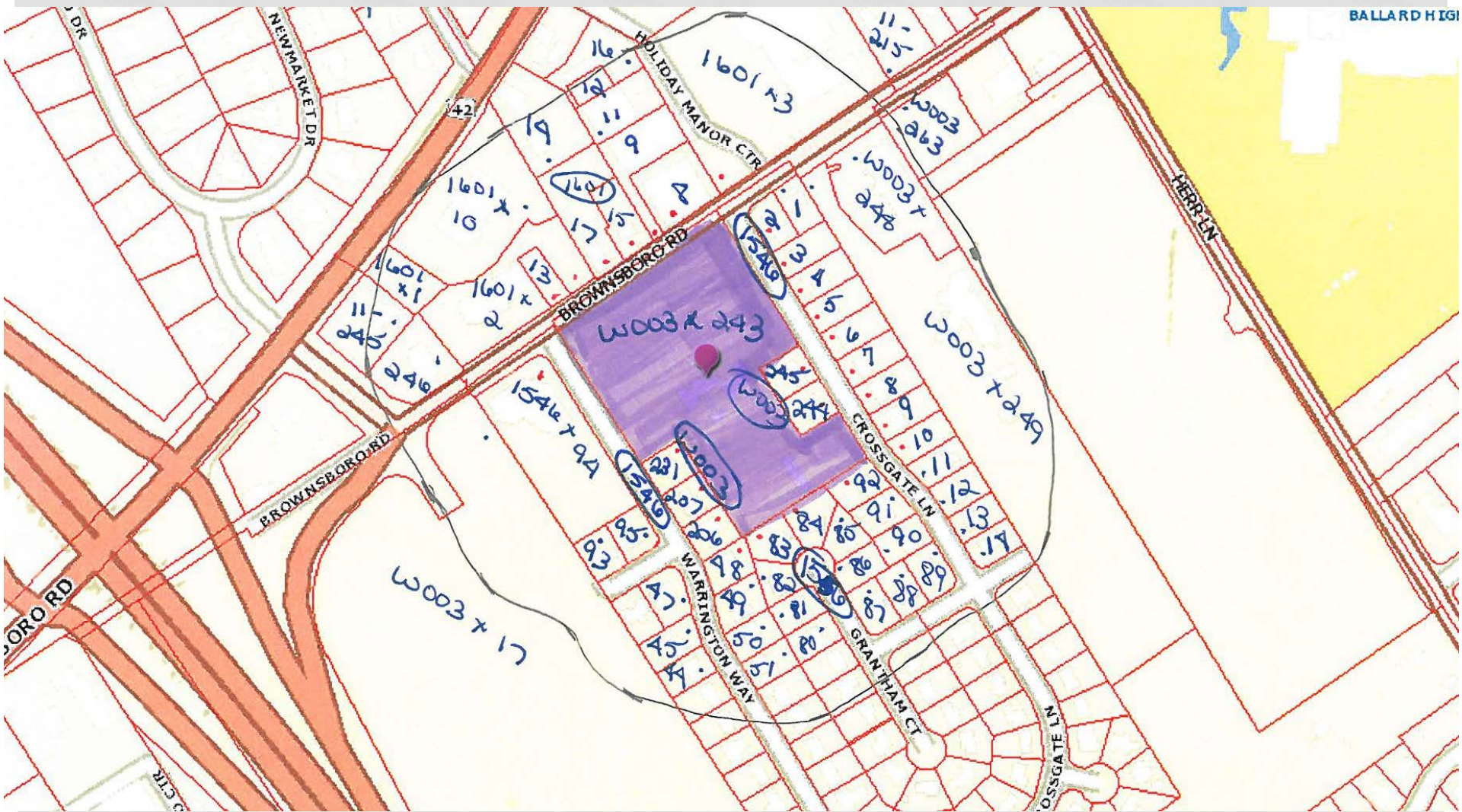

BARDENWERPER, TALBOTT & ROBERTS, PLLC

ATTORNEYS AT LAW

1000 N. HURSTBOURNE PARKWAY • BUILDING INDUSTRY ASSOCIATION OF GREATER LOUISVILLE BLDG. • SECOND FLOOR • LOUISVILLE, KENTUCKY 40223
(502) 426-6688 • (502) 425-0561 (FAX) • WWW.BARDLAW.NET

William B. Bardenwerper
Direct dial: 426-0388, ext. 125
Email: WBB@BARDLAW.NET

May 31, 2017

Dear Neighbor,

RE: Proposed conditional use permit (CUP) to allow a senior living facility at the rear of the site and a rezoning from R-4 to C-1 for two retail out-lots fronting on Brownsboro Road, all on approximately 6.6 acres at 4922 Brownsboro Road

We are writing to invite you to a meeting we have scheduled to present neighbors with our CUP and zone change application plan to allow a senior living facility and two retail out-lots located as above. The property is currently zoned R-4.

Accordingly, we will file a plan for pre-application review with the Division of Planning and Design Services (DPDS) that will be assigned a case number and case manager. We will have that information at the neighbor meeting. We would like to show and explain to neighbors this plan so that we might hear what thoughts, issues and perhaps even concerns you may have.

In that regard, a meeting will be held on **Wednesday, June 14th at 7:00 p.m.** at the **Thomas Jefferson Unitarian Church** in the **Hearth Room** located at **4936 Brownsboro Road**. *(Please enter through the "OFFICE" door.)*

If you cannot attend the meeting but have questions or concerns, please call me at 426-6688 or our land planning and engineering firm representatives Kevin Young or Ann Richard at 426-9374.

We look forward to seeing you.

Sincerely,

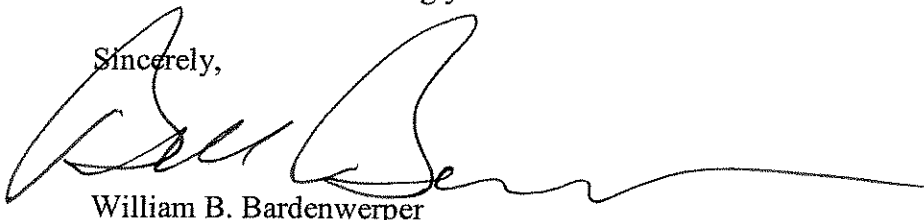

William B. Bardenwerper

cc: Hon. Angela Leet, Councilwoman, District 7
Brian Davis, Supervisor with Division of Planning & Design Services
Kevin Young and Ann Richard, landscape architects and land planners with Land Design & Development, Inc.
Thomas Jones, Artis Senior Living, Applicant

Neighborhood Meeting Summary

A neighborhood meeting was held on Wednesday, June 14th at 7:00 p.m. at the Thomas Jefferson Unitarian Church located at 4936 Brownsboro Road. Those in attendance included the applicant's representatives, attorney Bill Bardenwerper, with Bardenwerper Talbott & Roberts, PLLC and land planners Kevin Young and Ann Richard, with Land Design & Development, Inc. as well as the applicant.

Mr. Bardenwerper showed a PowerPoint presentation which included aerial photographs of the site, the proposed site plan, and the area along Brownsboro Road and Crossgate neighborhood.

The meeting began with Bill Bardenwerper introducing the applicant, represented by Thomas Jones, and the land planner/engineer, represented by Kevin Young from Land Design and Development, Inc. Mr. Bardenwerper showed the Power Point presentation of the area and nearby development. He did this so that everyone present was fully familiar with exactly the properties being considered and impacted. He described the need a Conditional Use Permit for the senior living facility at the rear of the site, and the change from R-4 zoning to C-1 zoning on the two retail out-lots fronting Brownsboro Road (KY 22) located at 4922 Brownsboro Road. He showed the proposed site plan, its perimeter buffers and setbacks, the location of parking, the footprint and elevation drawings of the proposed senior living facility, and also a rendition of potential buildings for the C-1 uses. He also explained that no specific use for the two retail out-lots had as of yet been determined.

Mr. Bardenwerper emphasized that the applicant was interested in the neighbors' concerns so that they could be best addressed and to make the ultimate plan a good one for everyone. He also explained how the DPDS "Case Management Review Process" works, how the various agencies will review the submitted plan and how those agencies' preliminary stamps of approval are required prior to this application being docketed for public meetings and hearings. He said that those attending this neighborhood meeting, and who have received notice thus far, will receive official notice of those meetings so that they can appear and comment on the application once it is finally and formally filed.

Most of the neighbors were amenable to the proposed senior living facility, generally agreeing that it was a reasonable use next the neighborhood, provided adequate landscape buffers and screening were instituted. Issues of traffic were discussed. It was explained, and seemingly understood, that the traffic from a senior living facility is generally not very intense and should not be problematic.

The main questions and concern dealt with the proposed retail out-lots and the possible C-1 uses. It was made clear that the applicant would limit the C-1 uses to not allow all C-1 uses, such as a car wash, but the neighbors attending the meeting, who appeared to all be residents of the Crossgate neighborhood, raised many objections to such development and concerns about the impact on the value of their real estate. Some neighbors similarly expressed concern about their homes facing a new retail development, in addition to the traffic it would generate on their neighborhood streets. Several of the attendees raised issues about access of the development to the streets of Crossgate Lane and Warrington Way. Mr. Bardenwerper expressed that the entrances were still being considered, and the applicant was in

communication with the Crossgate representatives on this issue. Mr. Bardenwerper explained that this was an informational meeting and that the attendees' comments and concerns would be considered in the plan ultimately filed.

The Mayor of Crossgate, Kirk Hibrecht, was in attendance, as well as Councilwoman Angela Leet.

TAB 5

PREVIOUS DEVELOPMENT PLANS

Original plan shown at the June 14, 2017 neighborhood meeting

- Front of site proposed as C-1 w/ rear of site remaining R-4 with a CUP
- 2 retail buildings of 7,200 sf each
- 2 retail buildings of 7,200 sf each
- Connections to 2 Crossgate streets, being Crossgate Lane and Warrington Way

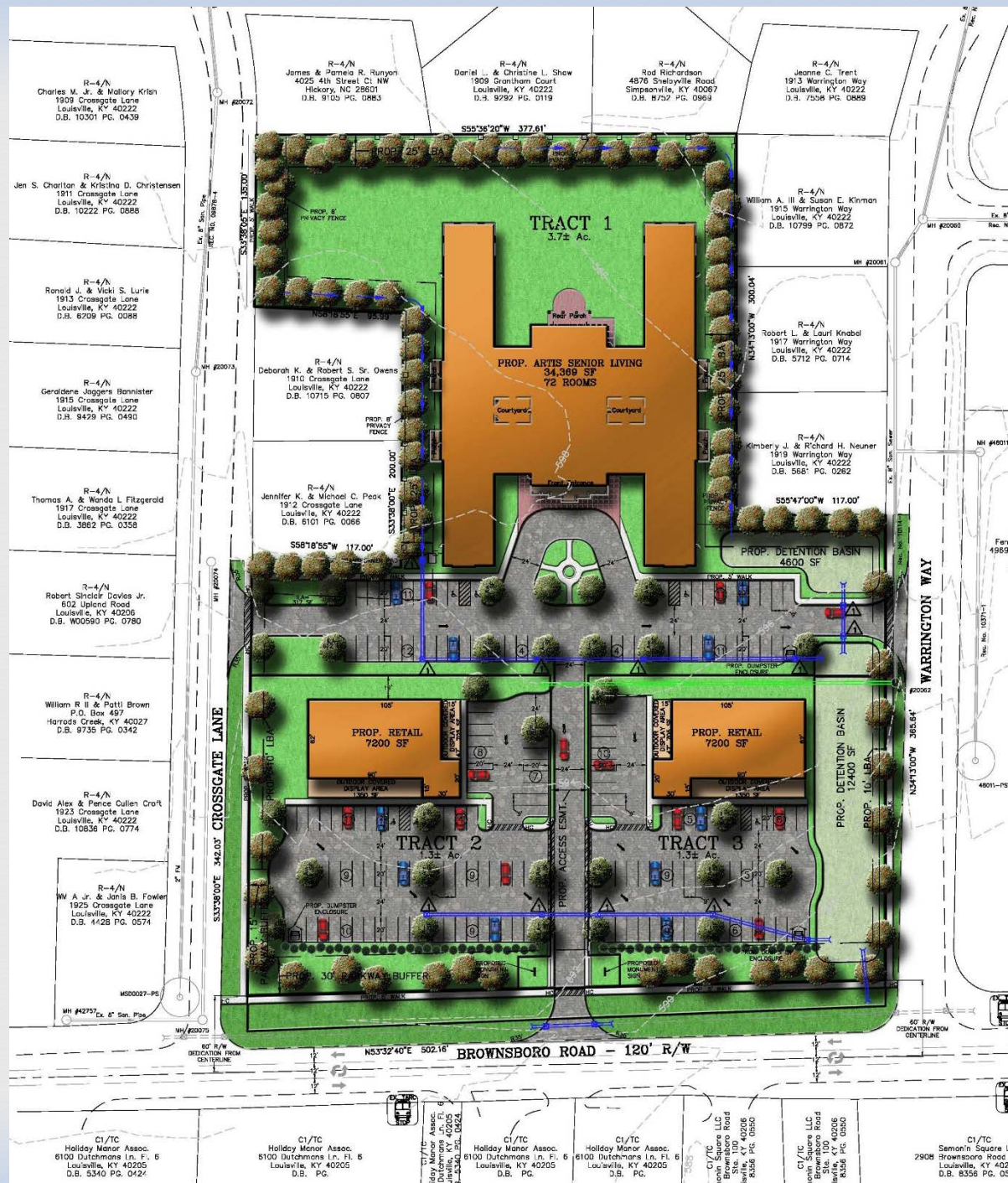

Second plan shown at the August 14, 2017 City of Crossgate meeting

- Front of site change from C-I to CN w/ rear of site remaining R-4 with a CUP
- 1 retail building changed to branch bank building
- Crossgate Lane access eliminated
- Warrington Way access proposed w/ fire gate



TAB 6

PROPOSED DEVELOPMENT PLAN

Current Development Plan

- Front left side of site remaining R-4
- Front right side of site proposed as CN
- Rear of site proposed to remain R-4 w/ a CUP
- Warrington Way access still proposed w/ fire gate

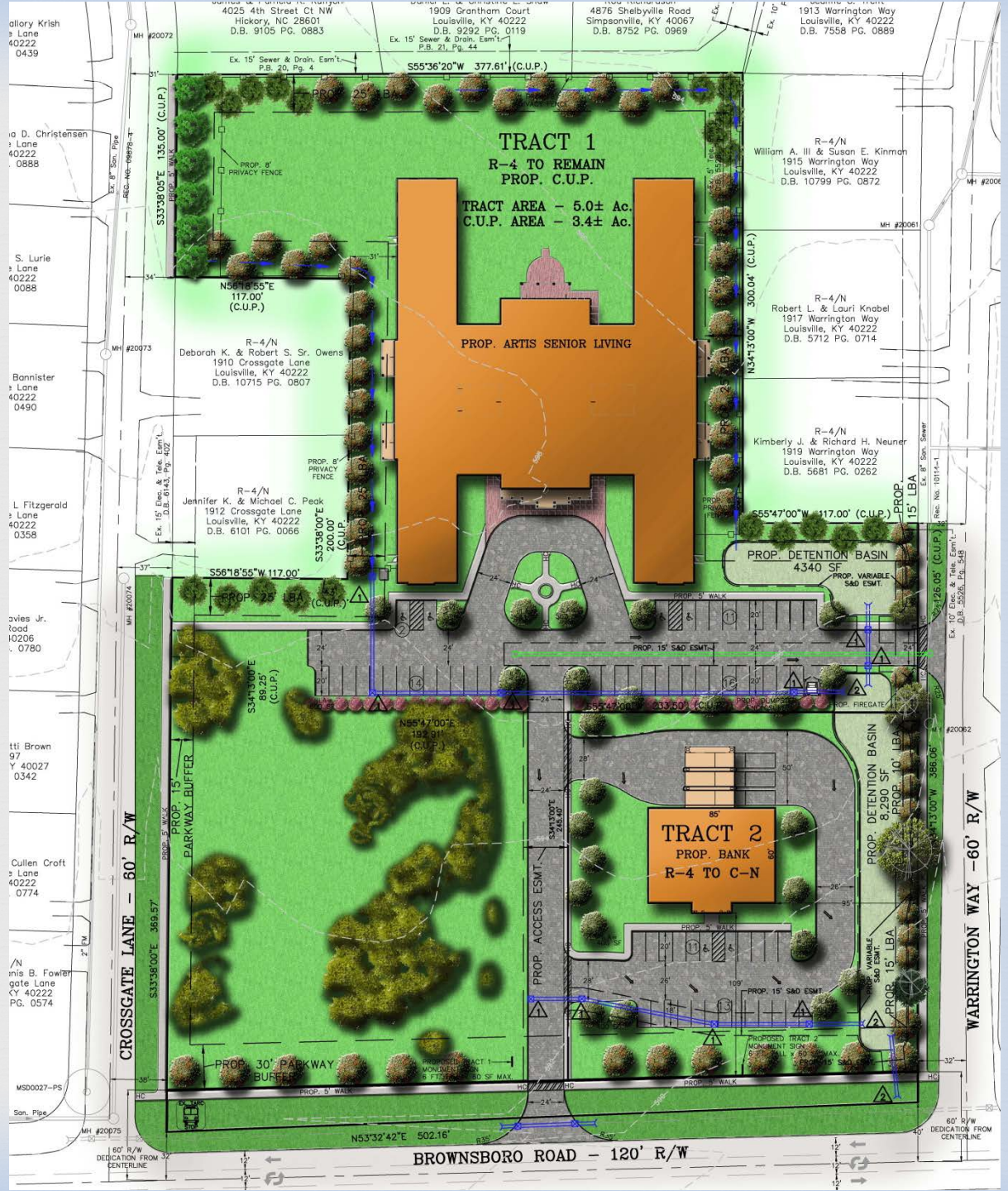

Rezoning and CUP Boundary Exhibit

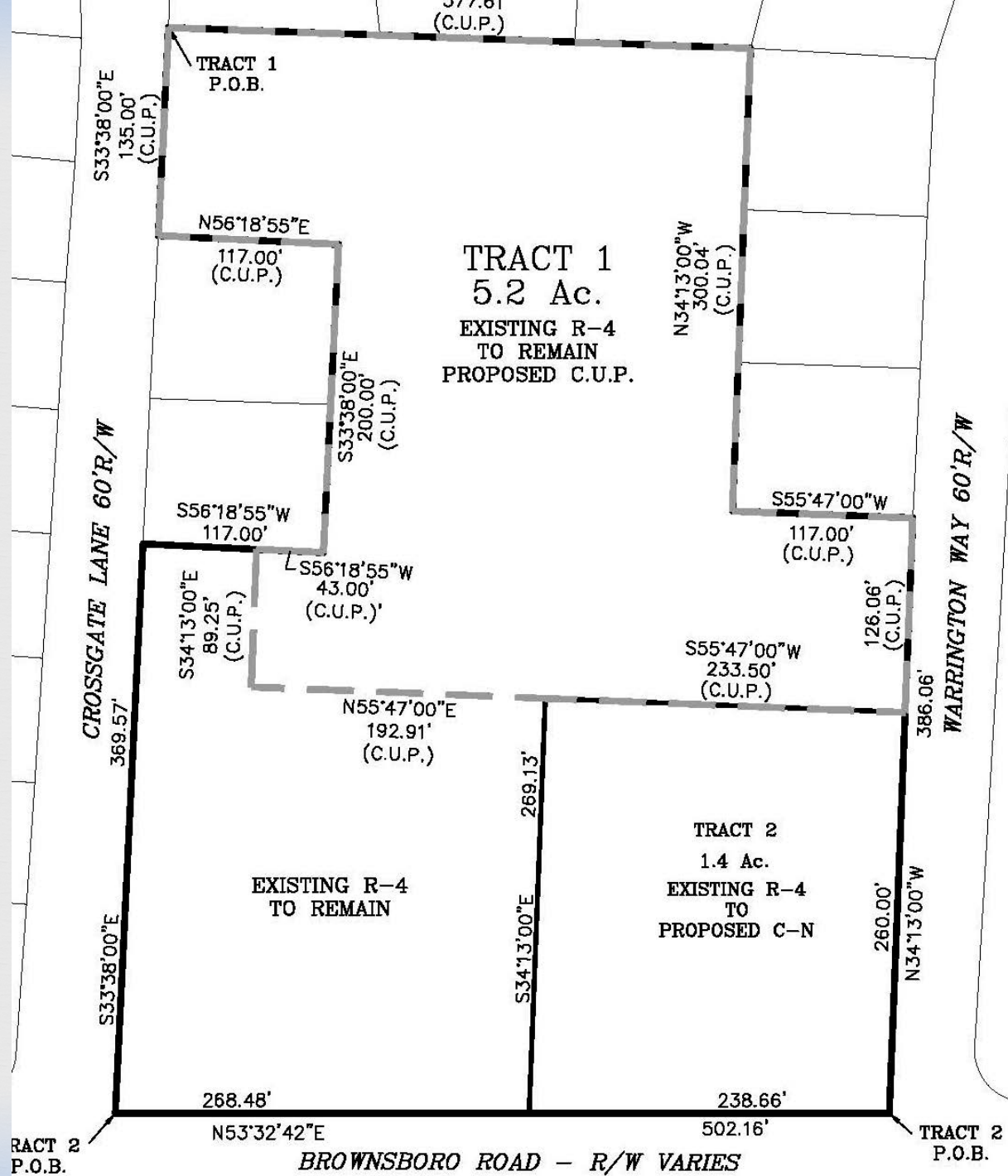

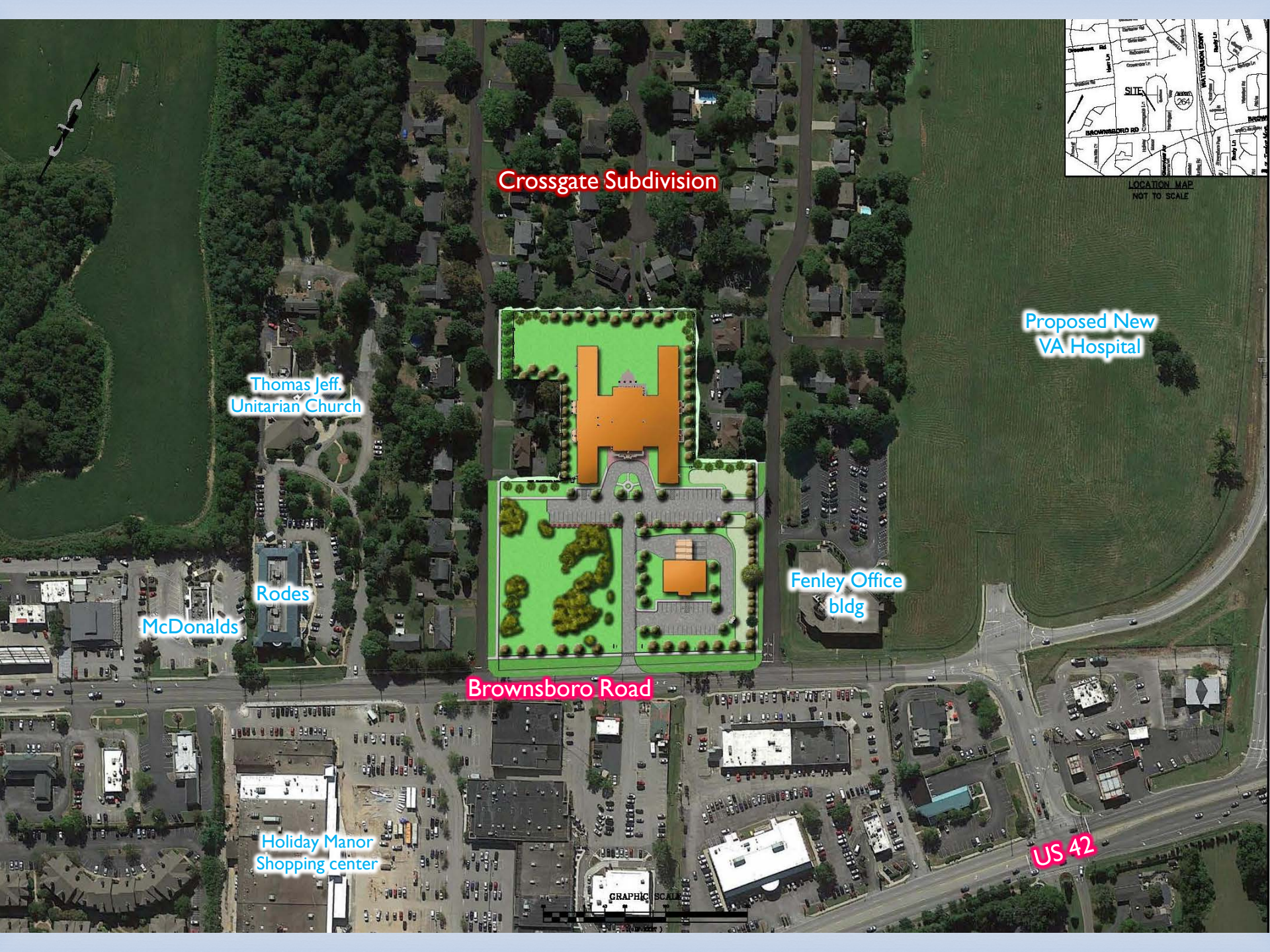

Crossgate Subdivision

Thomas Jeff.
Unitarian Church

Proposed New
VA Hospital

Rodes

McDonalds

Fenley Office
bldg

Brownsboro Road

Holiday Manor
Shopping center

US 42

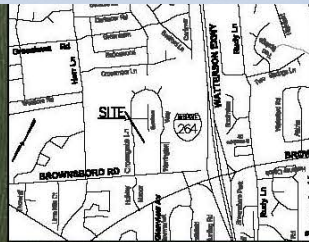

LOCATION MAP
NOT TO SCALE

GRAPHIC SCALE

Crossgate Subdivision

Thomas Jeff.
Unitarian Church

Rodes

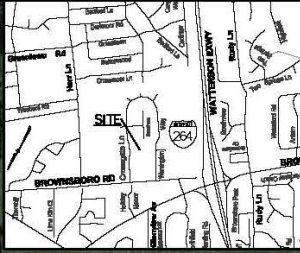

LOCATION MAP
NOT TO SCALE

Proposed New
VA Hospital

Fenley Office
bldg

Brownsboro Road

GRAPHIC SCALE

1" = 50 FT.

TAB 7

BUILDING ELEVATIONS

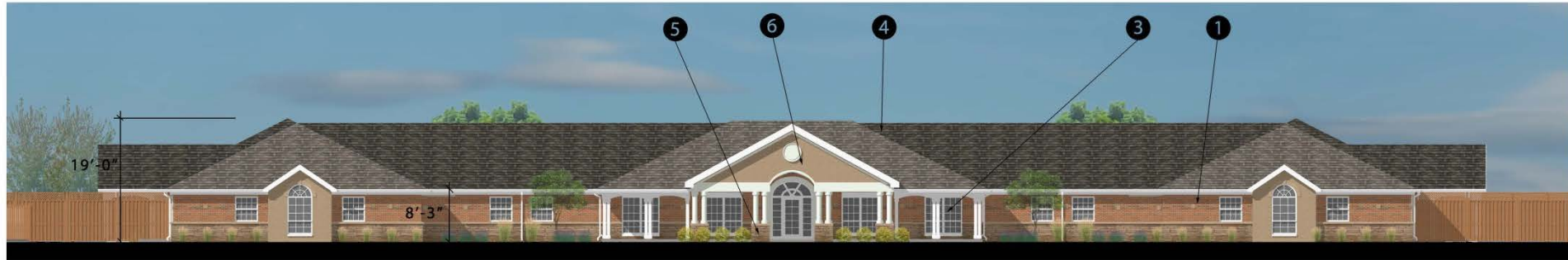

Front Elevation

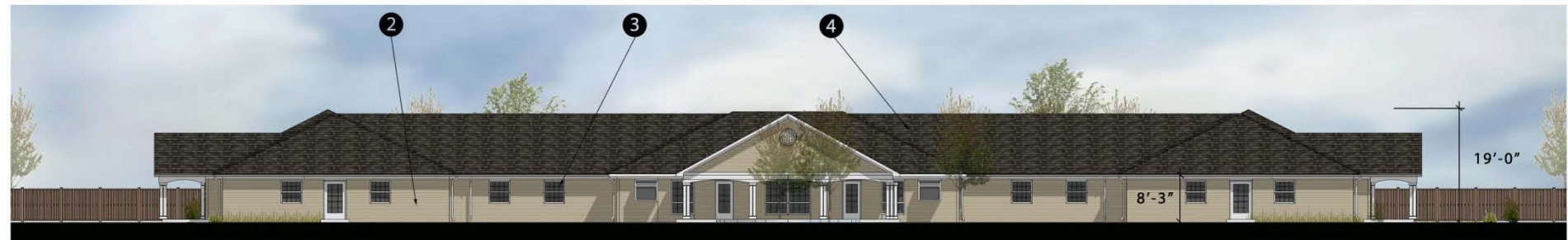

Rear Elevation

Upgraded architecture and building materials
from time of first neighborhood meeting

- | | |
|-----------------|-----------------------------|
| ① Brick Veneer | ④ Composite Shingle |
| ② Vinyl Siding | ⑤ Manufactured Stone Veneer |
| ③ Vinyl Windows | ⑥ Stucco |



Side Elevation

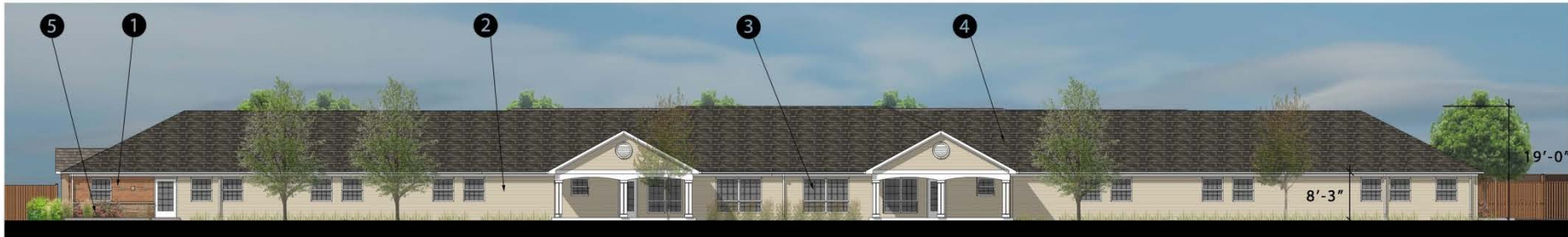

Side Elevation

Upgraded architecture and building materials from time of first neighborhood meeting

- | | |
|-----------------|-----------------------------|
| ① Brick Veneer | ④ Composite Shingle |
| ② Vinyl Siding | ⑤ Manufactured Stone Veneer |
| ③ Vinyl Windows | ⑥ Stucco |





TAB 8

TRAFFIC STUDY

final report

October 2, 2017

Traffic Impact Study

*Artis Senior Living
4922 Brownsboro Road
Louisville, KY*

Prepared for

**Louisville Metro Planning Commission
Kentucky Transportation Cabinet**

DIANE B. ZIMMERMAN
Traffic Engineering, LLC

13203 High Meadows Pike
Prospect, KY 40059
502-648-1858
dianebzvm@aol.net



Table 1. Peak Hour Trips Generated by Site

Land Use	A.M. Peak Hour			P.M. Peak Hour		
	Trips	IN	OUT	Trips	IN	OUT
Assisted Living (72 units)	13	9	4	21	10	11
Bank with Drive-Through (5,200 sq ft)	63	36	27	126	63	63
Total	76	45	31	147	73	74

No significant impacts on traffic

Table 2. Peak Hour Level of Service

Approach	A.M.			P.M.		
	2017 Existing	2020 No Build	2020 Build	2017 Existing	2020 No Build	2020 Build
US 42 at KY 22	F	F	F	D	D	D
	117.8	129.0	130.6	39.7	41.8	47.4
US 42 Eastbound	D 45.1	D 46.6	D 46.7	D 40.0	D 43.5	D 52.5
US 42 Westbound	F 177.3	F 195.0	F 195.8	C 30.1	C 31.0	C 33.7
KY 22 Northbound	F 90.3	F 102.2	F 110.4	D 52.5	D 52.5	D 52.4
Northfield Drive Southbound	E 65.6	E 65.4	E 65.4	E 76.1	E 75.8	E 75.8
I 264 ramp at KY 22	B	B	B	B	B	B
	12.7	13.3	14.1	13.6	14.3	15.4
I 264 ramp Eastbound	A 8.0	A 8.2	A 8.5	B 12.7	B 13.3	B 14.2
KY 22 Westbound	B 12.2	B 12.7	B 13.5	B 10.2	B 10.5	B 11.7
KY 22 Southbound	C 20.9	C 22.1	C 23.4	C 20.3	C 21.4	C 22.7
KY 22 at Warrington Way						
KY 22 Westbound	A 9.0	A 9.1	A 9.2	B 10.3	B 10.4	B 10.7
Warrington Way Northbound	C 17.5	C 18.0	C 18.5	C 19.5	C 20.1	C 21.4
KY 22 at Crossgate Lane						
KY 22 Westbound	A 9.0	A 9.1	A 9.1	B 10.7	B 10.9	B 11.1
Crossgate Lane Northbound	C 17.2	C 17.7	C 18.1	C 20.1	C 20.8	C 21.8
KY 22 at Herr Lane	C	C	C	C	C	C
	25.1	25.8	26.2	30.8	32.1	32.8
KY 22 Eastbound	C 23.6	C 24.0	C 24.2	C 26.7	C 27.8	C 28.1
KY 22 Westbound	C 23.0	C 28.9	C 24.1	C 23.6	C 24.5	C 25.0
Herr Lane Northbound	C 28.0	C 28.9	C 29.6	D 38.5	D 40.3	D 41.6
Lime Kiln Lane Southbound	C 29.8	C 30.8	C 31.6	D 41.4	D 43.3	D 44.6

Modest impacts No road improvements recommended

Approach	A.M.			P.M.		
	2017 Existing	2020 No Build	2020 Build	2017 Existing	2020 No Build	2020 Build
KY 22 at Entrance						
KY 22 Westbound			A 9.2			B 11.0
Entrance Northbound			C 17.2			D 27.0

Key: Level of Service, Delay in seconds per vehicle

CONCLUSIONS

Based upon the volume of traffic generated by the development and the amount of traffic forecasted for the year 2020, there will be a manageable impact to the existing highway network, with Levels of Service remaining within acceptable limits. The delays experienced in the area will increase within acceptable limits, therefore no improvements are recommended.

TAB 9

LIGHTING

Photometric Plan

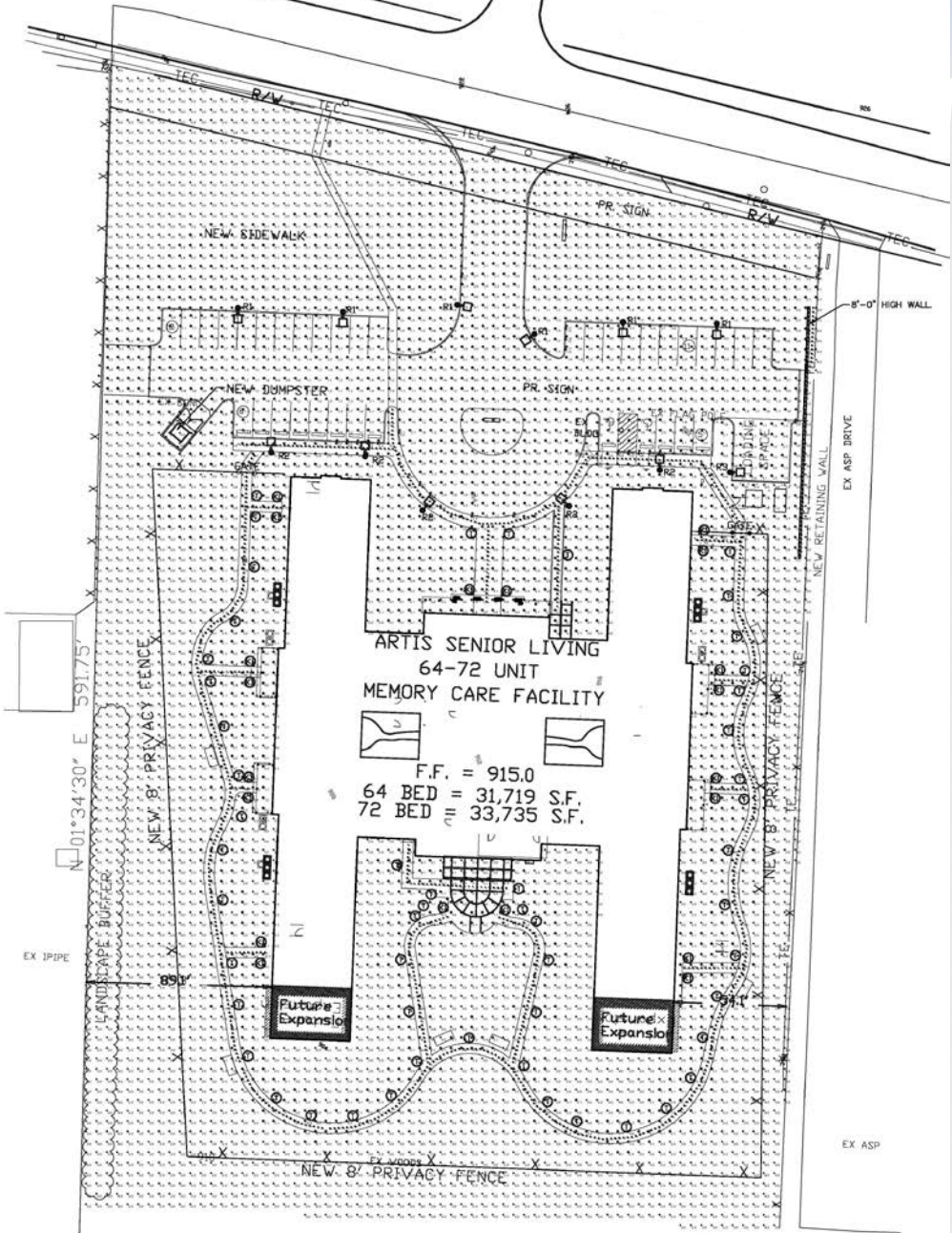

ARTIS SENIOR LIVING
64-72 UNIT
MEMORY CARE FACILITY

F.F. = 915.0
64 BED = 31,719 S.F.
72 BED = 33,735 S.F.

Photometric plan at service door entrance

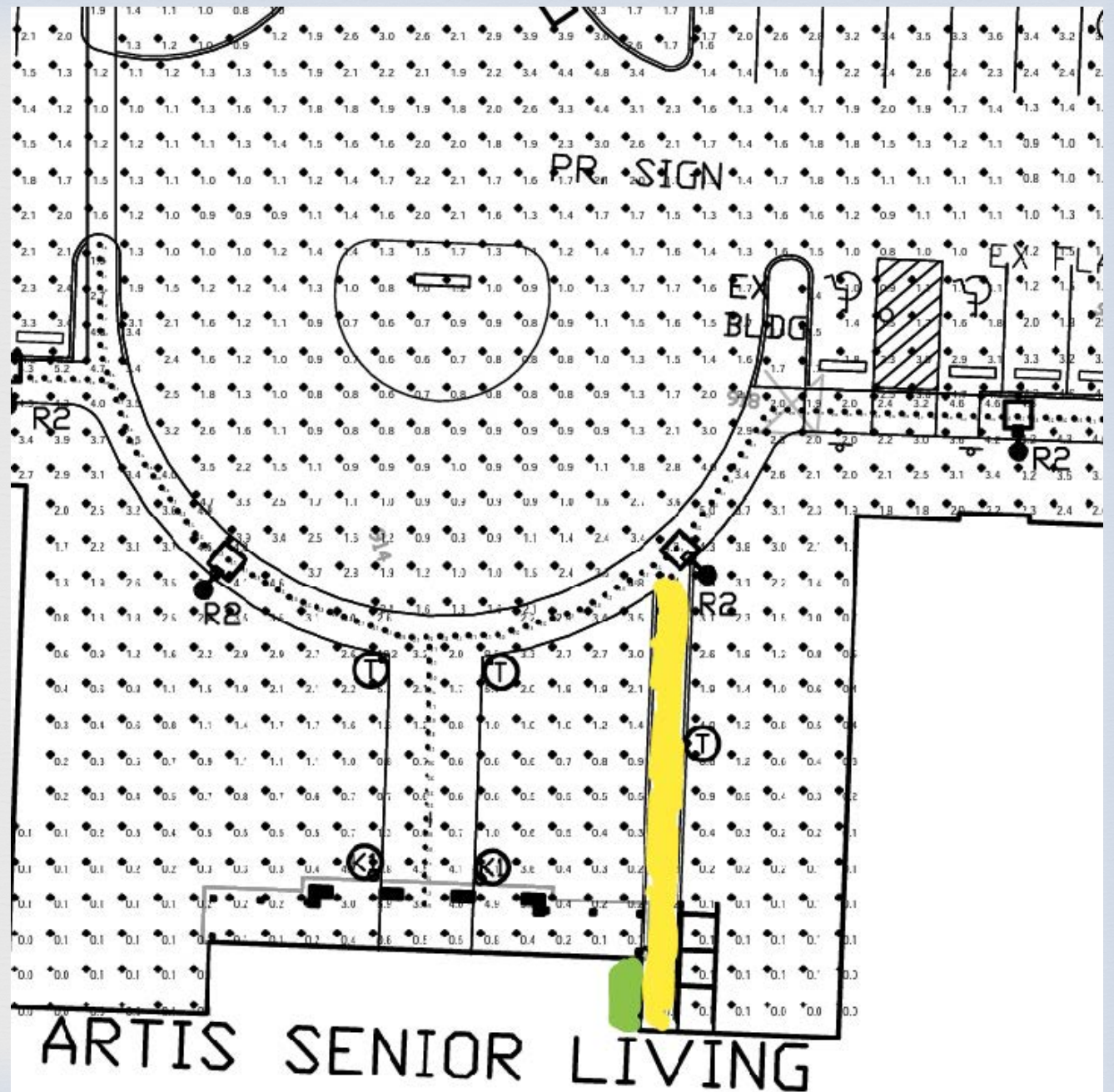

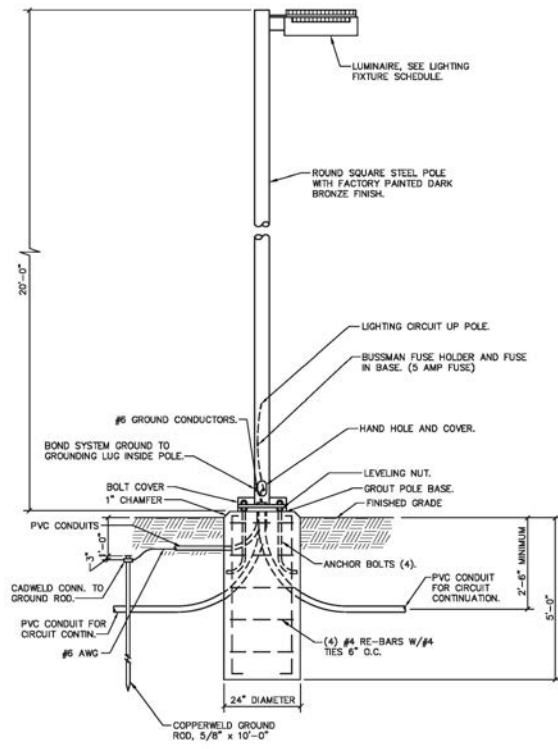

B FIXTURE TYPE 'R1', 'R2', 'R3' POLE BASE DETAIL N.T.S.

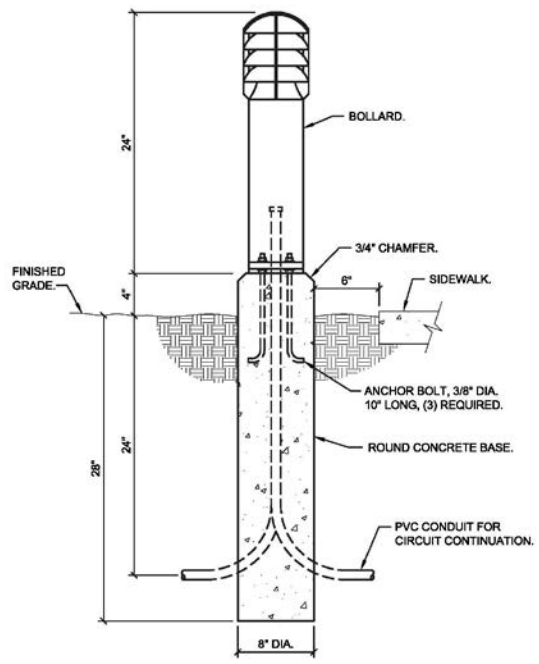

C FIXTURE TYPE 'K1' DETAIL N.T.S.

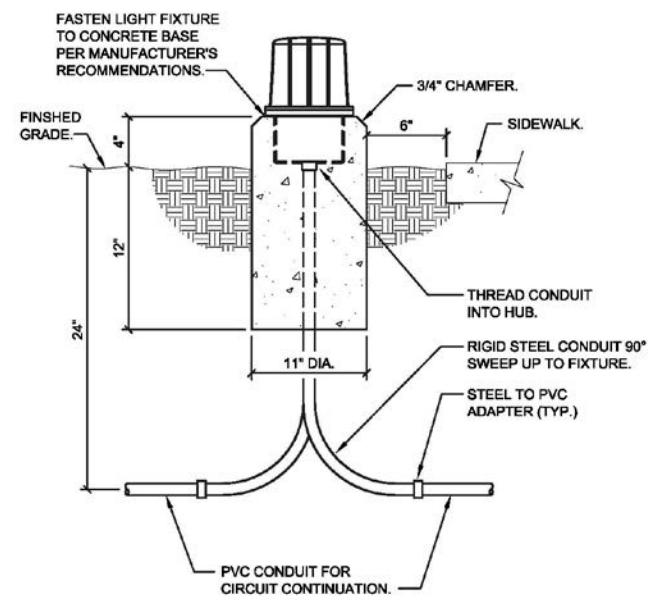

D FIXTURE TYPE 'T' DETAIL N.T.S.

TAB 10

PROPOSED FINDINGS OF FACT PERTAINING TO COMPLIANCE WITH THE COMPREHENSIVE PLAN

BARDENWERPER, TALBOTT & ROBERTS, PLLC

ATTORNEYS AT LAW

1000 N. HURSTBOURNE PARKWAY • BUILDING INDUSTRY ASSOCIATION OF GREATER LOUISVILLE BLDG. • SECOND FLOOR • LOUISVILLE, KENTUCKY 40223
(502) 426-6688 • (502) 425-0561 (FAX) • WWW.BARDLAW.NET

PROPOSED FINDINGS OF FACT REGARDING COMPLIANCE WITH ALL APPLICABLE GUIDELINES AND POLICIES OF THE CORNERSTONE 2020 COMPREHENSIVE PLAN

<u>Applicant:</u>	Artis Senior Living
<u>Owner:</u>	Kinman Compound, LLC
<u>Location:</u>	4922 Brownsboro Road
<u>Proposed Use:</u>	Bank/Senior Living Center
<u>Engineers, Land Planners and Landscape Architects:</u>	Land Design & Development, Inc.
<u>Request:</u>	Zone Change from R-4 to CN and a Conditional Use Permit (CUP) for a Senior Living Facility

The Louisville Metro Planning Commission, having heard testimony before its Land Development & Transportation Committee, in the Public Hearing held on November 6, 2017 and having reviewed evidence presented by the applicant and the staff's analysis of the application, make the following findings:

INTRODUCTION

WHEREAS, this property is one of the only remaining decent-size, reusable properties remaining along Brownsboro Road and US 42 in the proximity of the I-264 interchange; Brownsboro Road between Herr Lane and US 42 is all commercial except for this short frontage which is a large single family lot that pre-dates Crossgate Subdivision occupied until recently by Mrs. Kinman who recently entered a nursing home; her grown children live in homes adjoining it to the northeast and southwest; and the property has good access off Brownsboro Road and with this rezoning becomes part of an existing "activity center" which includes Holiday Manor across Brownsboro Road from this site; and

WHEREAS, the Kinman homestead is larger than needed by the proposed senior living facility, CN zoning is also being requested for just one out-lot fronting on Brownsboro Road for a branch bank (the other "out-lot" being left as permanent open space); in addition to the CN zone change for the one out-lot, the applicant is also requesting a Conditional Use Permit (CUP) for the remaining portion of the Kinman Homestead, presently planned as a dementia care senior living facility; everything is proposed as one-story so as to assure design compatibility with the adjoining City of Crossgate single family neighborhood; the only use of a Crossgate city street is proposed to be emergency access off Warrington Way, given the objection of the City of Crossgate to any other city street access; and homes across Crossgate Lane from the subject property will be substantially screened and buffered so as to preserve and protect their single family residential integrity; and

GUIDELINE 1 – COMMUNITY FORM

WHEREAS, the application complies with the Suburban Neighborhood Form District description of an area characterized by *predominantly* residential uses but that also includes, at appropriate locations, a mixture of uses, such as offices, retail shops, restaurants and services so long as these uses are at a scale appropriate for the nearby neighborhoods; the branch bank and senior living development (“development”) is precisely what is contemplated by the Suburban Neighborhood Form District with respect to uses other than low to medium density residential; and

GUIDELINE 2 – CENTERS

WHEREAS, the application complies with the Intents and applicable Policies 1, 2, 3, 4, 5, 7, 8, 9, 11, 13, 14 and 15 of this Guideline because the subject property adjoins the mixture of commercial and single-family residential uses mentioned above, placing it in or adding it to the activity center that already exists in and around this location; with goods and services already available along Brownsboro Road, including within the Kroger anchored Holiday Manor shopping center across Brownsboro Road, this development makes excellent use of this unusually large single family property; as part of an existing or addition to an “activity center”, this development is appropriately located along a minor arterial road very close to US 42, a major arterial road, and it is designed to be of intensity, density, size and mix of uses appropriate for this location at the front door of the small city of Crossgate; and

WHEREAS, this location is now considered an infill site where road, sewer and drainage infrastructure already exist; the senior living facility component of this development brings to this area an enhanced level of elder care where an existing support population already exists; the development as a whole is clearly compact, with the mixture of uses above mentioned, all compatible with this development’s residential neighbors; and to some extent parking is shared, while access is fully shared; and

GUIDELINE 3 – COMPATIBILITY

WHEREAS, the application complies with the Intents and applicable Policies 1, 2, 3, 4, 5, 6, 7, 8, 9, 10, 12, 13, 14, 15, 16, 20, 21, 22, 23, 24 and 28 of this Guideline because, as set forth above, this development will have an attractive look and feel, nicely landscaped and constructed of upscale, durable building materials and of a height and scale compatible with the style, design and scale of nearby residential properties; it will be newer and more upscale than the older commercial development across Brownsboro Road from this site; there will be no odor or noise nuisances that would potentially emanate from the development because of the branch bank on the front and senior living facility in the rear of this site; lighting will follow restrictions of the Land Development Code (LDC) and as demonstrated in the exhibits produced in the Public Hearing, and thus be directed down and away from nearby residential properties, with 90 degree cut-off at property lines; transitions to adjoining residential properties will be intensively and attractively screened with landscaping; loading and delivery will be located and/or screened so as to minimize impacts on nearby residential properties; signage will be in conformance with the LDC; the senior living facility adds to the variety of housing needed in a community to serve a growing aging population, unfortunately increasingly dementia afflicted; and

GUIDELINE 6 – ECONOMIC GROWTH AND SUSTAINABILITY

WHEREAS, the application complies with the Intents and applicable Policies 2, 5, 6 and 11 of this Guideline because as set forth above, this property is located along Brownsboro Road and close to US Hwy 42, both of which are minor/major arterials; that places this development in close proximity to the population it intends to serve with elder care services and branch banking which reduces public and private costs for land development, reduces travel times and distances and ensures adaptive reuse of an extra-large single family lot in a manner that well serves the existing city of Crossgate, other nearby residential neighborhoods and the traveling public along Brownsboro Road and US 42; and

GUIDELINE 7, 8 AND 9 – CIRCULATION, TRANSPORTATION FACILITY DESIGN AND BICYCLE, PEDESTRIAN AND TRANSIT

WHEREAS, the application complies with the Intents and applicable Policies 1, 2, 4, 6, 9, 10, 11, 12, 13, 14, 15, 16 and 18 of Guideline 7; Policies 1, 4, 5, 7, 9, 10 and 11 of Guideline 8; and Policies 1, 2, 3 and 4 of Guideline 9 because traffic utilizing this development will have access off of Brownsboro Road, with only emergency access proposed to be off one of the Crossgate city streets; the design of this development, together with its points of access, take into account the standards promulgated by KTC and Metro Transportation Planning and Public Works; the latter reviewed the detailed district development plan (DDDP) and gave its preliminary stamp of approval prior to time of LD&T and Planning Commission public reviews, which assures that Transportation Planning and Public Works standards for corner clearances, access, connectivity, internal circulation and parking minimums are all satisfied; and bike racks and sidewalks will be provided as required; and

GUIDELINES 10 - FLOODING AND STORMWATER

WHEREAS, the application complies with the Intents and applicable Policies 1, 3, 6, 7, 10 and 11 of this Guideline because storm water drainage will be routed to on-site catch basins and there directed to on-side detention basins and from there into the existing storm water system; MSD reviewed the storm water management plan and gave its preliminary stamp of approval to the DDDP prior to docketing for LD&T and Planning Commission public reviews; and

GUIDELINE 11 – WATER QUALITY

WHEREAS, the application complies with the Intents and applicable Policies 3, 5 and 8 of this Guideline because MSD has promulgated both soil erosion/sedimentation control regulations and even newer ones with respect to water quality; construction plans for this development will require compliance with these regulations prior to obtaining building permits; and

GUIDELINE 12 – AIR QUALITY

WHEREAS, the application complies with the Intents and applicable Policies 2, 4, 7 and 8 of this Guideline because this proposed development is located in close proximity to a large residential support population, notably along Brownsboro Road; this will help reduce vehicle miles traveled because more branch banking and senior care services will be located in close proximity thereto; and

GUIDELINE 13 – LANDSCAPE CHARACTER

WHEREAS, the application complies with the Intents and applicable Policies 1, 2, 4, 5 and 6 of this Guideline because Compliance with this Guideline is achieved by virtue of compliance with LDC requirements; and as stated above, landscaping, screening and buffering will exceed LDC requirements, as promised neighbors at the neighborhood meeting; and

* * * * *

WHEREAS, for all the reasons explained at LD&T and the Planning Commission public hearing and also in the public hearing exhibit books on the approved detailed district development plan, this application also complies with all other applicable Guidelines and Policies of the Cornerstone 2020 Comprehensive Plan;

NOW, THEREFORE, the Louisville Metro Planning Commission hereby recommends to the Louisville Metro Council that it rezone the subject property from R-4 to C-N and approves the Detailed District Development Plan.

NOW, THEREFORE, the Louisville Metro Planning Commission hereby Approves the Conditional Use Permit.